

1323200001

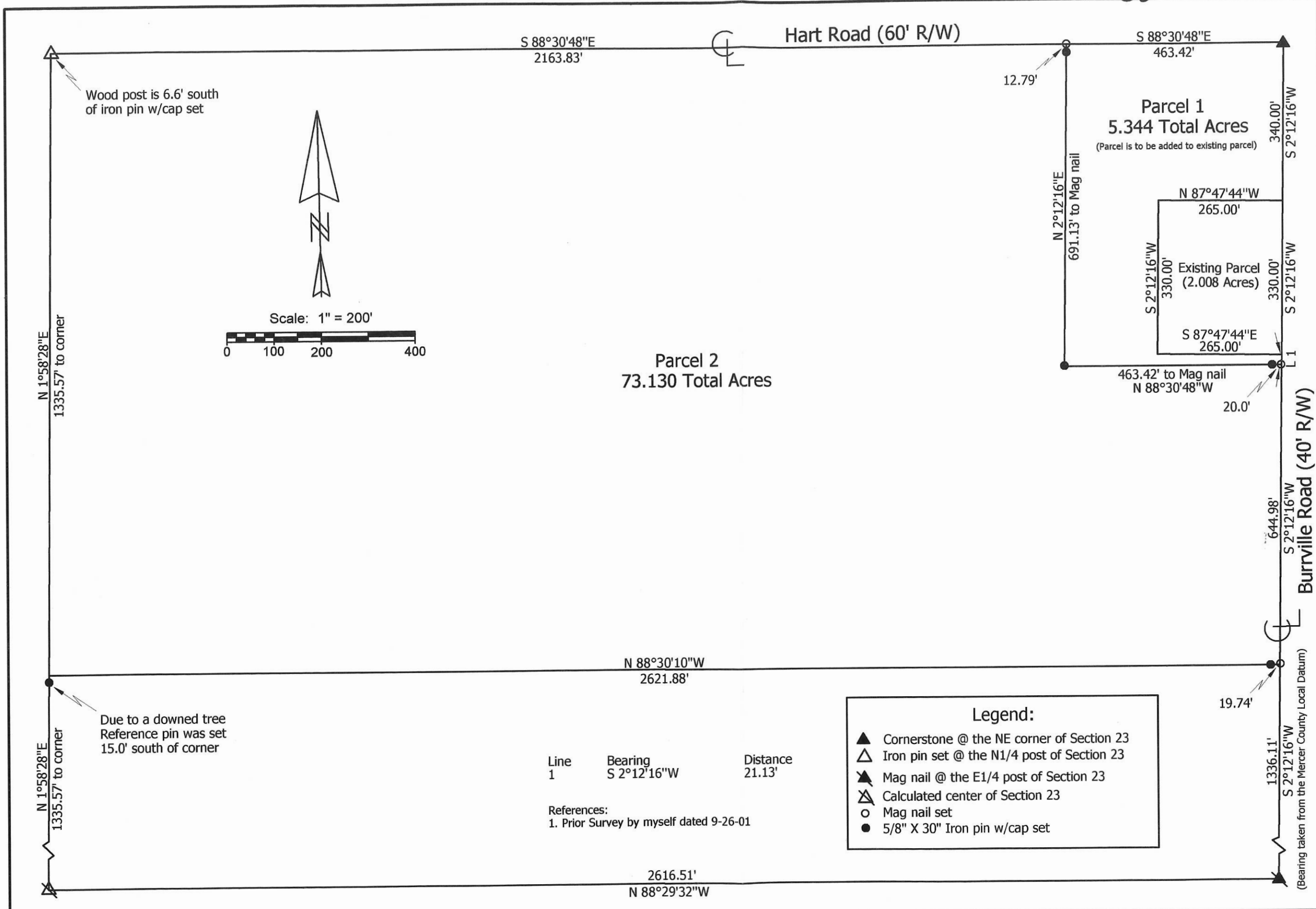

Hart Survey

State of: Ohio County: Mercer

Township: Gibson Sec: 23 Town: 15N Range: 1E

City/Village: _____ Subdivision: _____ Lot: _____

Deed References: Vol. 326, Page 678 Date Surveyed: 6-5-12

Approvals: _____
Agency: Board of Health
Date: _____

_____ Township Zoning Inspector
_____ County Engineer

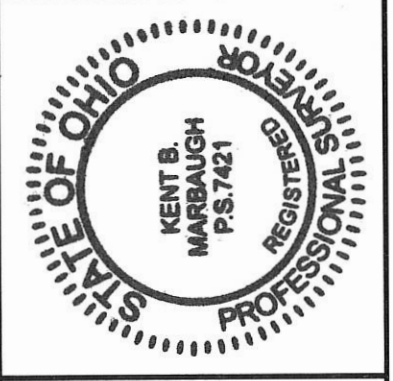

Marbaugh Land Surveying

1901 Carolina Court
Celina, Ohio 45822
(419) 586-4293

Kent Marbaugh
Kent B. Marbaugh P.S. 7421

13-F (23)

13-23-300-004 ; 13-23-400-005 ; 13-23-400-001 ; 13-23-300-001

13-F

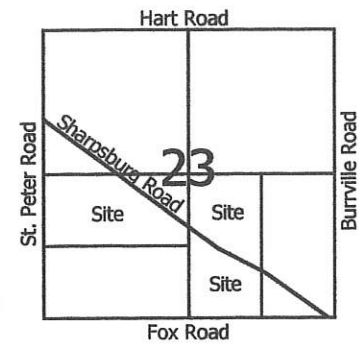

Note: Dug for stone @ N1/4 post without success

Legend:

- △ Cornerstone @ the S1/4 Post of Section 23
- ▲ Calculated center of Section 23
- ⊠ Iron pin @ the SW corner of Section 23
- ⬤ Cornerstone @ the W1/4 Post of Section 23
- ⊠ Cornerstone @ the SE corner of Section 23
- ▲ Iron Pipe @ the E1/4 Post of Section 23
- Wood post on south side of Hart Road
- 5/8" X 30" Iron Pin w/cap set
- Mag nail set
- ⊙ 5/8" X 30" Iron Pin w/cap set on line and 20.00' from corner

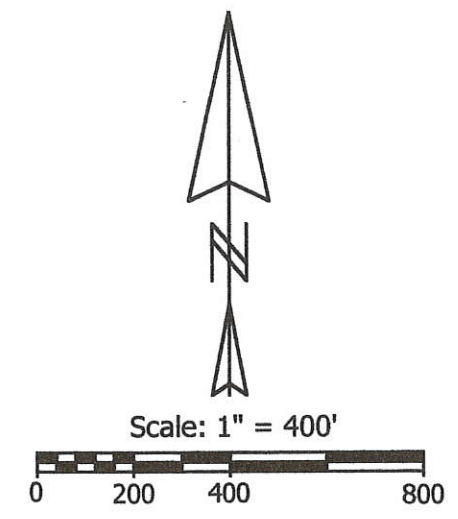
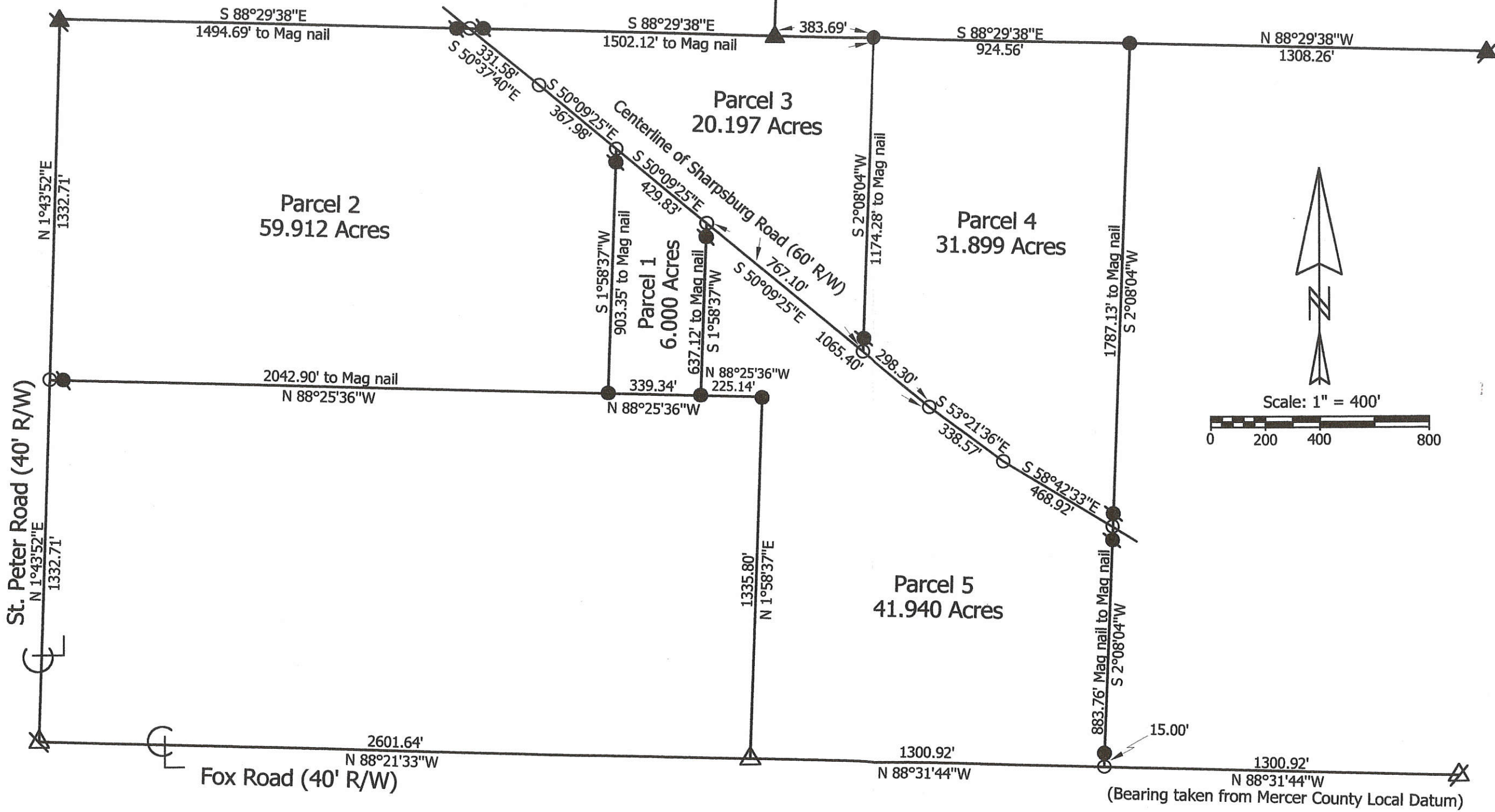

(Bearing taken from Mercer County Local Datum)

George Jones Estate Survey

State of: Ohio County: Mercer

Township: Gibson Sec: 23 Town: 15N Range: 1E

City/Village: _____ Subdivision: _____ Lot: _____

Deed References: Vol.282, Pg.732 Date Surveyed: 9-26-01

Approvals: _____ Board of Health
 Agency: _____ Date: _____
 _____ County Engineer



Marbaugh Land Surveying

1210 Yorkshire Court
 Celina, Ohio 45822
 (419) 586-4293

Kent Marbaugh
 Kent B. Marbaugh P.S.7421

ROBERT METZGAR SURVEY
 Part S 1/2 NW 1/4 Section 23, T15N, R1E
 Gibson Twp., Mercer Co., Ohio
 May 28, 1966

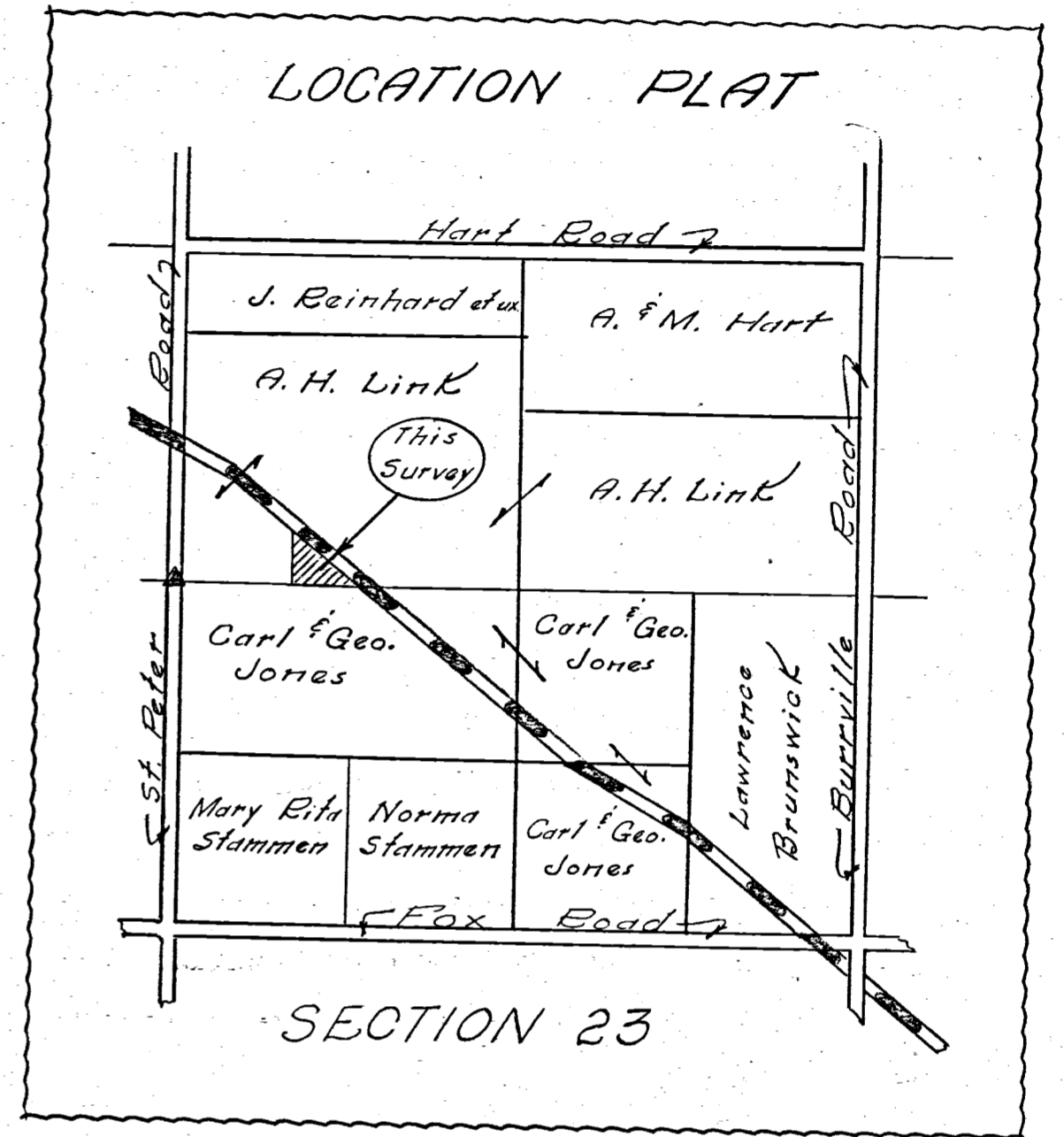

Scale: 1" = 40'

Legend:

- ▲ = Section Stone
- ⊙ = Iron Survey Stake
- = 5/8" reinforcing rod
- = Nail & Survey cap
- = Wood corner post
- x- = Wire fence

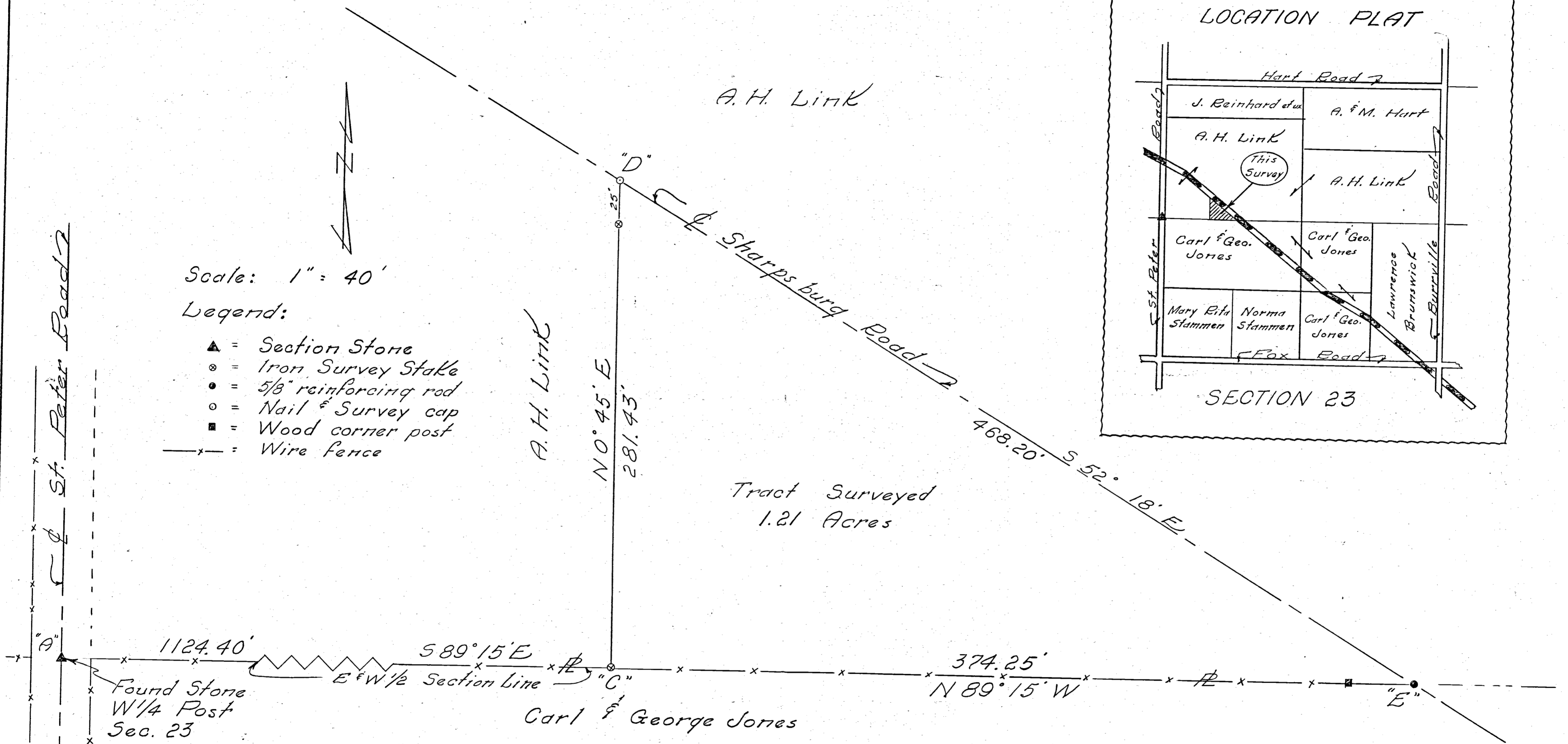

To all parties interested in title to premises surveyed,
 I hereby certify this survey showing corner stones, survey stakes
 and iron pin markers is correct to the best of my knowledge
 and belief.

May 31, 1966

B. R. Nebhart

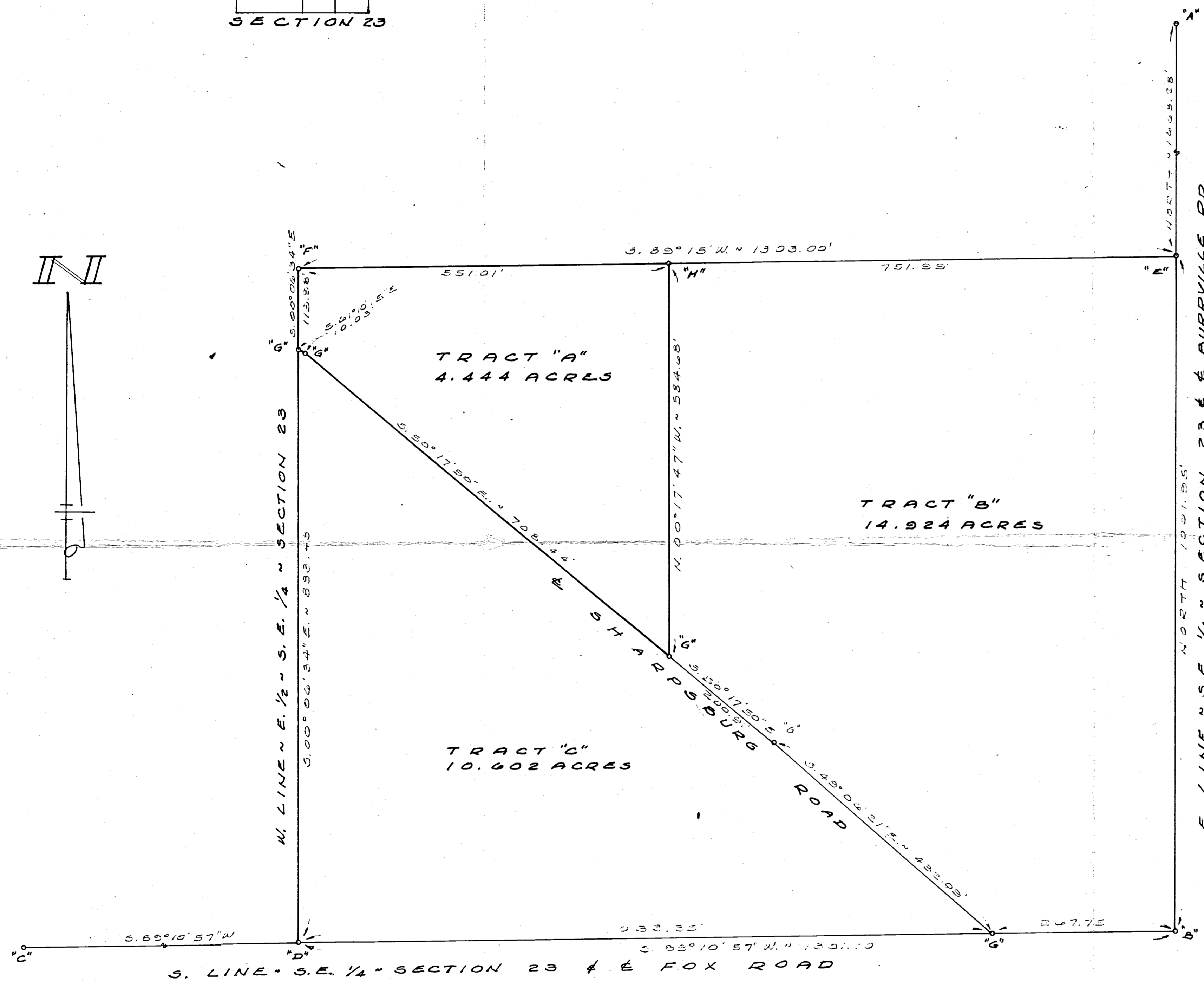
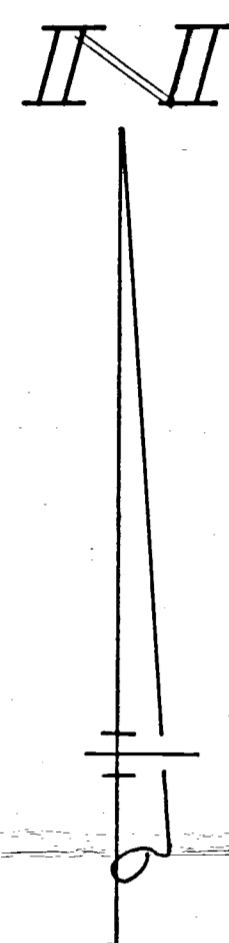
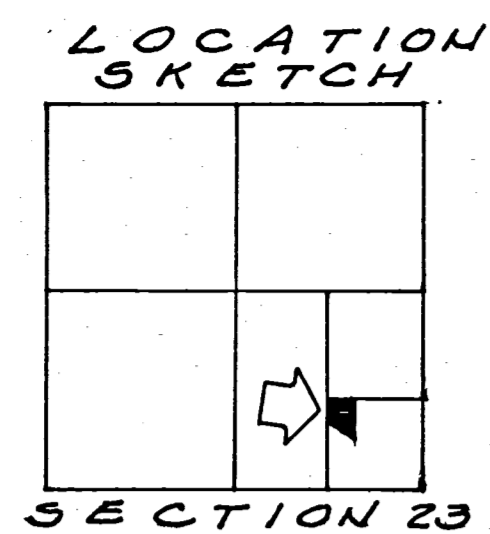

LEGEND

- "A" = IRON PIPE FD. @ E. 1/4 POST - SEC. 23.
- "B" = RAILROAD SPIKE OVER STONE @ S.E. COR. SEC. 23
- "C" = RAILROAD SPIKE OVER STONE @ S. 1/4 POST - SEC. 23.
- "D" = RAILROAD SPIKE FD. 3.11' N. OF 4.05' E. OF CORNER.
- "E" = RAILROAD SPIKE FD. 0.106' S. OF 3.13' E. OF CORNER.
- "F" = CORNER POST FD. 3.08' E. OF CORNER.
- "G" = RAILROAD SPIKE SET.
- "H" = 5/8 INCH IRON BAR SET.

NOTE

THIS SURVEY IS BASED ON A SURVEY BY R. STAHL DATED 11 MARCH 1947.

SURVEYED BY

Gordon L. Geeslin
 GORDON L. GEESLIN
 REGISTERED SURVEYOR
 NO. 5372
 540 E. MARKET STREET
 CELINA, OHIO 45822



ABELS SURVEY - PART OF THE E. 1/2 OF THE S.E. 1/4 OF SECTION 23, TOWN 15 NORTH, RANGE 1 EAST (GIBSON TOWNSHIP), MERCER COUNTY, OHIO.
 AUGUST, 1981 SCALE 1" = 100'

To the Board of Commissioners of Mercer County, Ohio:

The undersigned, in obedience to your order, dated February 23 ~~xx~~ 2016, proceeded, on the Resolution # 16-179 and the day of September 17, 2019 to survey and mark the centerline of Sharpsburg Road described in said order, under the direction of the viewers therein named, and respectfully submits the following return of said survey

Being the approximate centerline of Sharpsburg Road, beginning at an iron pin found on Sharpsburg Road and the south section line of Section 15, Town 15 North, Range 1 East, Gibson Township, thence in an Easterly and South Easterly direction to the intersection of St. Peter Road, thence Easterly and South Easterly to a magrail found in the approximate centerline of Sharpsburg Road, as described in sections shown on survey plat below.

Note: Bearings and distances can be determined to the Mercer County Local Coordinate Datum with a rotation specified on survey plat. On file at the Mercer County Engineers office and Mercer County Tax Map office.

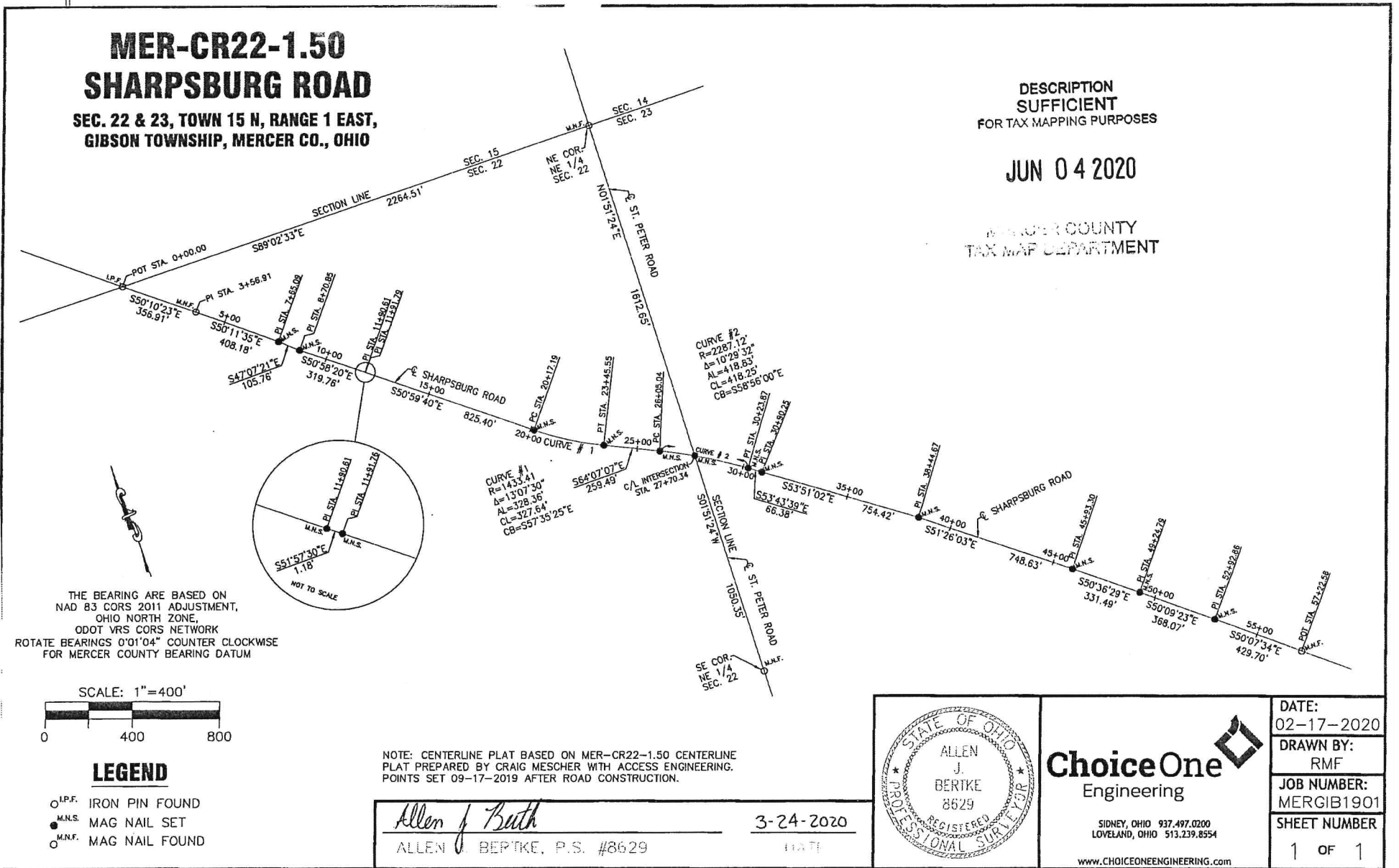

I certify that the above is a correct plat and return of the survey of the centerline plat of Sharpsburg Road

named above Gibson Township

James A. Weichert Surveyor of Said Mercer County

NE 23 15N 01E Gibson Mercer Ohio
 Quarter Section Township Range Township County State

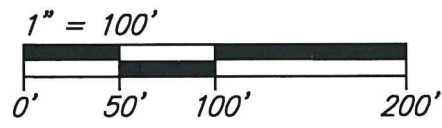

Bearings are based upon the east line of the Northeast Quarter of Section 23, being S02°13'09"W, per the State Plane Coordinate System, NAD 83 (2011 Adjustment), Ohio North Zone.

Said east line of the Northeast Quarter of Section 23 is referenced to MCLCDS as being S02°12'16"W.

Approvals

[Signature] DATE 5-24-21
 TOWNSHIP ZONING INSPECTOR

[Signature] DATE 5-27-21
 MERCER COUNTY ENGINEER

[Signature] DATE 5-27-21
 MERCER COUNTY HEALTH COMMISSIONER

Survey References

- *1 ~ Mercer County Engineer's Office Stone Notes
- *2 ~ Hart Survey dated 6-5-12 by Kent B. Marbaugh, P.S. #7421

Residential Setbacks

Front = 75' from R
 Rear = 30'
 Side = 20'

Vicinity Map

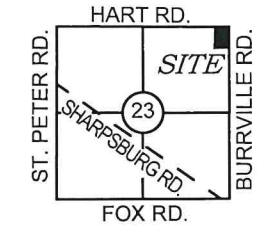

[Signature] Date: 05-10-21
 Surveyed By:
 Lee M. Thieman
 Registered Professional Surveyor #8758

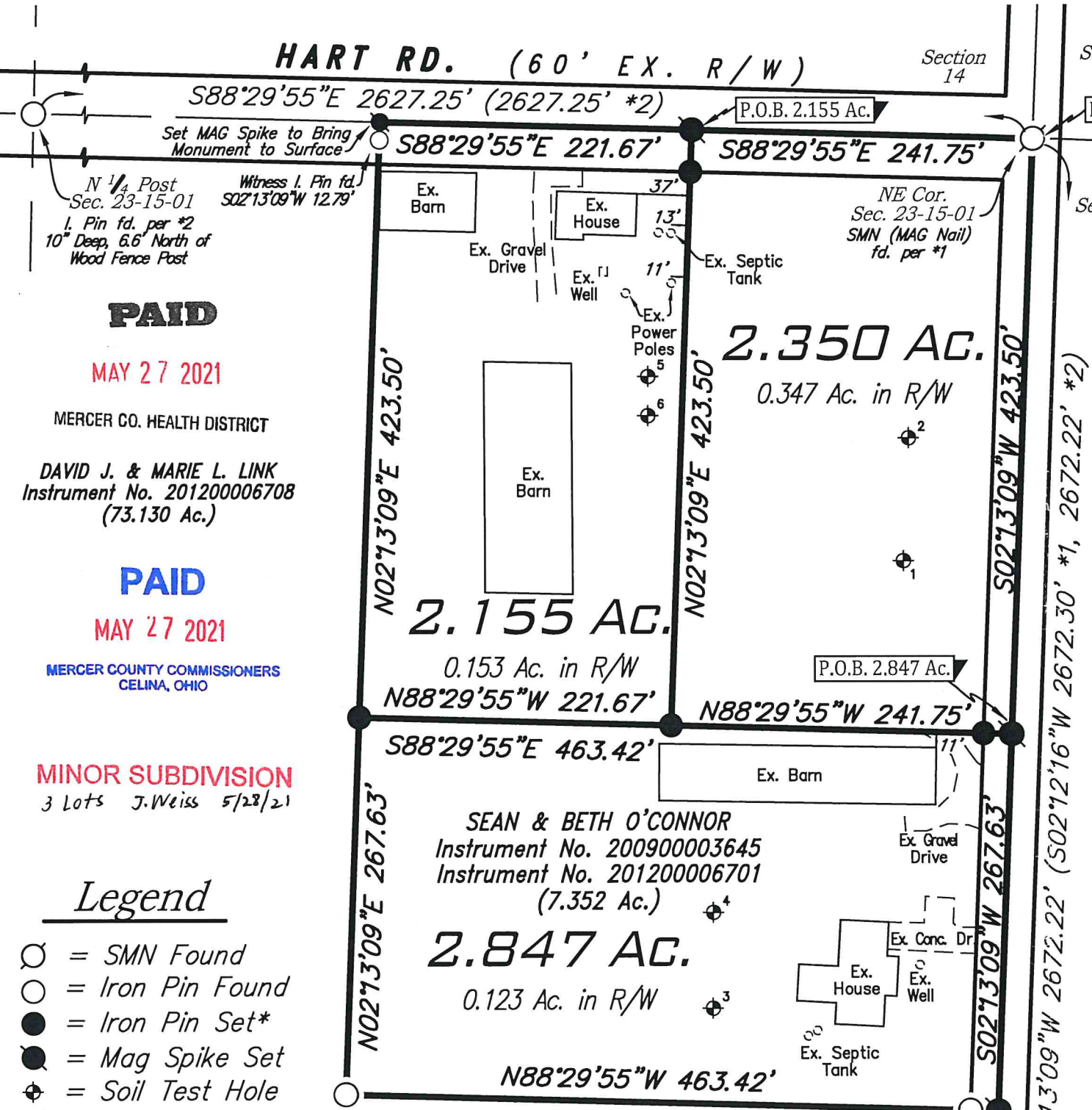

PAID
 MAY 27 2021
 MERCER CO. HEALTH DISTRICT
 DAVID J. & MARIE L. LINK
 Instrument No. 201200006708
 (73.130 Ac.)

PAID
 MAY 27 2021
 MERCER COUNTY COMMISSIONERS
 CELINA, OHIO

MINOR SUBDIVISION
 3 Lots J. Weiss 5/28/21

Legend

- = SMN Found
- = Iron Pin Found
- = Iron Pin Set*
- = Mag Spike Set
- ⊕ = Soil Test Hole
- R/W = Right-of-Way
- * = 5/8" x 30" reinforcing rod with aluminum cap stamped "THIEMAN PS 8758"

Note: Record information is enclosed by parentheses.

13-23-200-002
 -006
 13-23

No.	Date	Revision	By

PLAT OF SURVEY
 for
 SEAN O'CONNOR

THIEMAN
 ENGINEERING
 SURVEYING, LLC
 3838 Hunter Rd., Greenville, Ohio
 (419) 733-4487

Project No. 21-005
 Date 05-10-21
 Drawn By LMT
 Checked By LMT
 Drawing No. B-013