

DESCRIPTION OF SURVEY

11-16B
116226001

Part of the Northeast 1/4 of Section 16, Town 7 South, Range 2 East, Granville Township, Mercer County, Ohio described as beginning at the Northeast corner of Section 16 and proceeding thence South 00 degrees 04 minutes 36 seconds East 200.00 feet along the East line of Section 16; thence South 90 degrees 00 minutes 00 seconds West 200.00 feet parallel with the North line of Section 16; thence North 00 degrees 04 minutes 36 seconds West 200.00 feet parallel with the East line of Section 16; thence North 90 degrees 00 minutes 00 seconds East 200.00 feet along the North line of Section 16 to the point of beginning, containing 0.9182 acres except any part taken, used or deeded for road purposes.

CARTA-GENA RD.

N.E. COR., SEC. 16
T. 7 S., R. 2 E.
GRANVILLE TWP.
MERCER COUNTY
OHIO

N. Line, Sec. 16, T. 7 S., R. 2 E.

N 90°00'00" E 200.00'

N. 1/4 COR., SEC. 16
T. 7 S., R. 2 E.
GRANVILLE TWP.

#118

0.918 Ac.

STATE ROUTE

E. Line, Sec. 16, T. 7 S., R. 2 E.



SCALE - 1" = 40'

N 00°04'36" W 200.00'

S 00°04'36" E 200.00'

S 90°00'00" W 200.00'



E. 1/4 COR., SEC. 16
T. 7 S., R. 2 E.

FILED IN SURVEY BOOK

To: ANR Pipeline Co.
I, David R. Greer

, a Registered Surveyor in the State of Ohio, hereby certify that I have surveyed the parcel(s) of land described and delineated hereon; that said plat is true representation of the survey as performed by me; that there are no encroachments other than as shown hereon; that said survey was performed with an error of closure not greater than 1 in 5000;

This survey was made from the attached legal description. The description was given to us by the person certified to, or was prepared by us from information or documents given to us by the person certified to, and should be compared with the Abstract of Title or Title insurance policy for accuracy, easements or exceptions. This survey was based on the title description of this property and any written or unwritten rights of adjoining are unknown unless specifically noted.

David R Greer

Registered Land Surveyor No. 5702

LEGEND

- ☐ SET WOOD STAKE P PLAT
- SET CAPPED IRON BAR M MEASURED
- FOUND IRON STAKE D DESCRIPTION

HOLLAND ENGINEERING, INC.		
418 E. 8TH STREET HOLLAND, MICHIGAN 49423/392-5938		
Date 8-29-89	Drawn By BB	Surveyed By
Sec. 16 T. 7 S. R. 2 E. Granville Twp.		Job No. 89-05-164
Sheet 1 of 1 Sheets		

116 276 010 to 033

PART OF THE NORTHEAST 1/4, SECTION 16, TOWNSHIP 7 SOUTH, RANGE 2 EAST, GRANVILLE TOWNSHIP, VILLAGE OF ST. HENRY, MERCER COUNTY, OHIO

LINUS J. AND SANDRA CULNE VOLUME 271 PAGE 71 36.947 ACRES

NORTHERN HEIGHTS SUBDIVISION



LEGAL DESCRIPTION

Being a tract in the Northeast Quarter of Section 16, Granville Township, Town 7 South, Range 2 East, Mercer County, Village of St. Henry, Ohio, being more particularly described as follows:

Commencing at an Iron Pin in a Monument Box Found marking the East Quarter Post of said Section 16;

Thence North 88°35'16" West along the South line of the Northeast Quarter of Section 16, a distance of five hundred sixty and zero hundredths feet (560.00') to an Iron Pin Found, for the TRUE POINT OF BEGINNING;

Thence continuing North 88°35'16" West along the South line of the Northeast Quarter of Section 16 and the North line of the Walnut Grove Subdivision as recorded in Plat Cabinet 1~Page 341, a distance of seven hundred eighty-eight and twenty hundredths feet (788.20') to a Steel Post Found;

Thence North 01°44'11" East along the East line of a tract as recorded in Instrument #200400008618, a distance of six hundred sixty-five and eight hundredths feet (665.08') to an Iron Pin Set;

Thence South 88°34'07" East a distance of eight hundred ninety-five and ninety-six hundredths feet (895.96') to an Iron Pin Found;

Thence South 01°43'00" West along the West line of a tract as recorded in Instrument #200400005645, a distance of four hundred ninety-one and eighty-two hundredths feet (491.82') to a point in the Branch of Coldwater Creek, passing an Iron Pin Found at 441.82';

Thence South 43°01'19" West along the centerline of a Branch of Coldwater Creek and the West line of Woodland Estates as recorded in Plat Cabinet 1~Page 129, a distance of one hundred forty-one and ninety hundredths feet (141.90') to a point;

Thence South 25°52'39" West along the centerline of a Branch of Coldwater Creek and the West line of said Woodland Estates, a distance of thirty-five and zero hundredths feet (35.00') to a Mag Nail Set, passing a Mag Nail Set at 7.53';

Thence South 01°43'00" West along the West line of said Woodland Estates, a distance of thirty-five and zero hundredths feet (35.00') to the TRUE POINT OF BEGINNING, passing a Mag Nail Set at 5.00', containing 13.404 Acres of land more or less.

Said tract being subject to all highways and any other easements or restrictions of record.

Previous Deed Reference: Volume 271~Page 71

Description based on a survey by Craig W. Mescher Registered Surveyor No. 8237 in March, 2015 and is on file with the Mercer County Engineers Office.

DEDICATION

KNOWN ALL MEN BY THESE PRESENTS;

That Lange Developments, LLC, the owners of the land on the accompanying plat, have caused the area encompassed by this plat to be surveyed, platted, and to be known as Northern Heights Subdivision. Furthermore, we do hereby dedicate the roadways appearing hereon to the use of the public forever. All utility easements and building setback lines shall be strictly adhered to as shown on this plat.

Clay Lange - Managing Member _____ Date _____

ACKNOWLEDGMENT

STATE OF OHIO
COUNTY OF MERCER:

Before me a Notary Public in and for said County of Mercer, State of Ohio, personally appeared the above signed owners and acknowledged the signing of the above to be their free act and deed, and the duly authorized act and deed of said Owner.

In testimony whereof I have affixed my hand and seal this _____ day of _____, 20____.

Notary _____ Expiration Date _____

VILLAGE ACCEPTANCE

This plat of Northern Heights Subdivision to the Village of St. Henry, Ohio has been accepted by the Council of the Village of St. Henry by Ordinance No. _____, dated this _____ day of _____, 20____.

Mayor - Jeffery Mescher _____ Date _____

Clerk - Ruth Miller _____ Date _____

OWNER/DEVELOPER:
LANGE DEVELOPMENTS, LLC
821 COOPER DRIVE
ST. HENRY, OHIO 45883

RECORDER'S CERTIFICATE

Received for record this _____ day of _____, 20____. Recorded in Instrument # _____ Fee: _____

Mercer County Recorder, Angelo N. King

COUNTY AUDITOR'S CERTIFICATE

I hereby certify that there are no unpaid taxes on land comprising the Northern Heights Subdivision and that this plat was filed for transfer in the office of the Mercer County Auditor this _____ day of _____, 20____.

Mercer County Auditor, Randall E. Grapner

These lots are subject to additional declarations, covenants and restrictions recorded in Official Records Instrument # _____ in the Mercer County Recorder's Office.

I hereby certify that this plat is true and accurate to the best of my knowledge by Craig W. Mescher Registered Surveyor No. 8237, in November of 2015. Iron pins to be set after construction of utilities and streets.

Craig W. Mescher
Professional Surveyor #8237



LEGEND

- 5/8" IRON PIN W/ CAP FOUND
- 5/8" IRON PIN SET
- ⊙ STEEL POST FOUND
- ⦿ PK/MAG NAIL SET

NUMBER OF LOTS: 24
TOTAL AREA OF PLAT: 13.404 ACRES
TOTAL AREA OF R/W: 2.379 ACRES
PROP ZONE: R-1
EXISTING ZONE: R-1

EASEMENTS AND FRONT BUILDING LINES AS SHOWN ON THE PLAT.
SIDE SETBACK: 8'
REAR SETBACK: 25'
SIDE LOT EASEMENTS ARE 7.5' (15' TOTAL) UNLESS OTHERWISE NOTED

Curve Table

Curve #	Length	Radius	Delta	Chord Direction	Chord Length
C1	31.52	20.00	90.31	N43° 24' 58"W	28.36
C2	31.31	20.00	89.69	N46° 35' 02"E	28.21
C3	31.52	20.00	90.31	N43° 24' 58"W	28.36
C4	31.31	20.00	89.69	N46° 35' 02"E	28.21
C5	21.03	25.00	48.19	S67° 20' 12"W	20.41
C6	59.73	50.00	68.44	N77° 27' 46"E	56.24
C7	60.87	50.00	69.75	S33° 26' 33"E	57.18
C8	61.34	50.00	70.29	S36° 34' 29"W	57.56
C9	59.26	50.00	67.90	N74° 19' 50"W	55.85
C10	21.03	25.00	48.19	S64° 28' 26"E	20.41

Map 19, 2015, 12:35:45 PM, P:\21589011\Northern Heights Subdivision Final Plat.dwg



1116276010 to 1116276033

SURVEY FOR LINUS AND SANDRA CLUNE

OHIO STATE MERCER COUNTY GRANVILLE TOWNSHIP ST. HENRY VILLAGE 16 SECTION 7S TOWN 2E RANGE

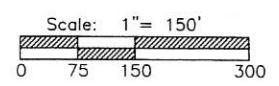
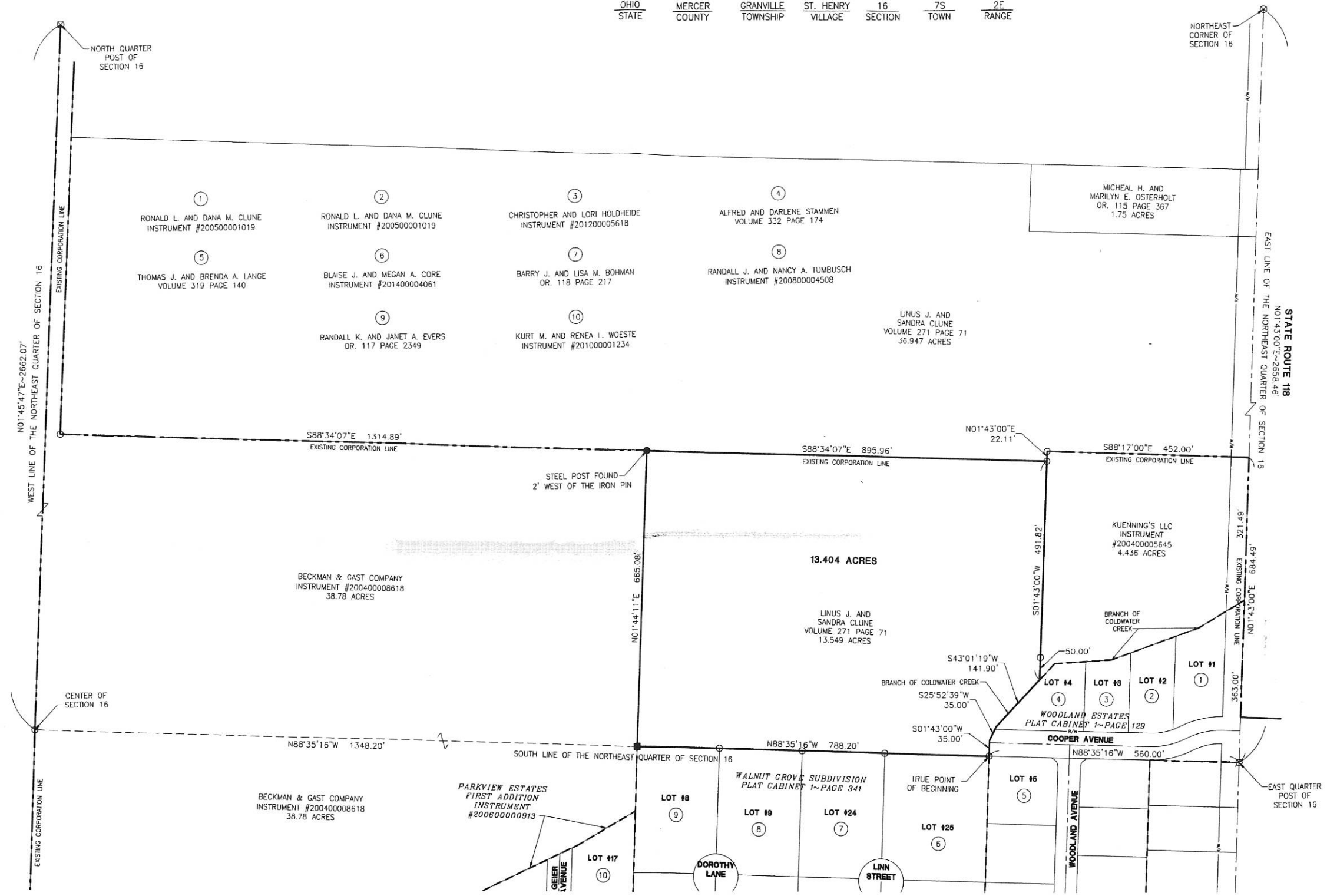

- LEGEND**
- ☐ Monument Box Found
 - Iron Pin Found
 - Iron Pin Set
 - ⊙ Mag Nail Set
 - ⊗ Mag Nail Found
 - Steel Post Found
 - △ Section Corner

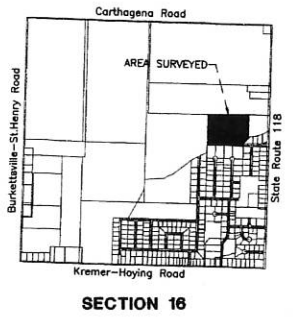

References:
 Woodland Estates-Plat Cabinet 1~Page 129
 Walnut Grove Subdivision-Plat Cabinet 1~Page 341
 Parkview Estates First Addition-Instrument #200600000913
 Annexation Plat to the Village of St. Henry-Instrument #200500003307
 Clune Survey by Eric C. Thomas PS #7236 in August of 1995
 Clune Survey by Eric C. Thomas PS #7236 in October of 1995



Surveyed By: *Craig W. Mescher*
 Craig W. Mescher Reg. Surveyor No. 8237
 Date: March 13, 2015

PROJECT # 215808.19

ACCESS
 Engineering Solutions

1200 IRMSCHER BLVD., SUITE B, CELINA, OH 45822
 www.accessengllc.com | 419-586-1430

971-11

116276006

11-16B

SURVEY OF A 4.436 AC. TRACT FOR LINUS CLUNE
LOCATED IN THE N.E. 1/4 OF SEC. 16, T-7-S, R-2-E,
GRANVILLE TWP., MERCER COUNTY, STATE OF OHIO

LINUS & SANDRA CLUNE

Vol. 271, Pg. 71

N.E. CORNER SEC. 16
I. PIN OVER STONE

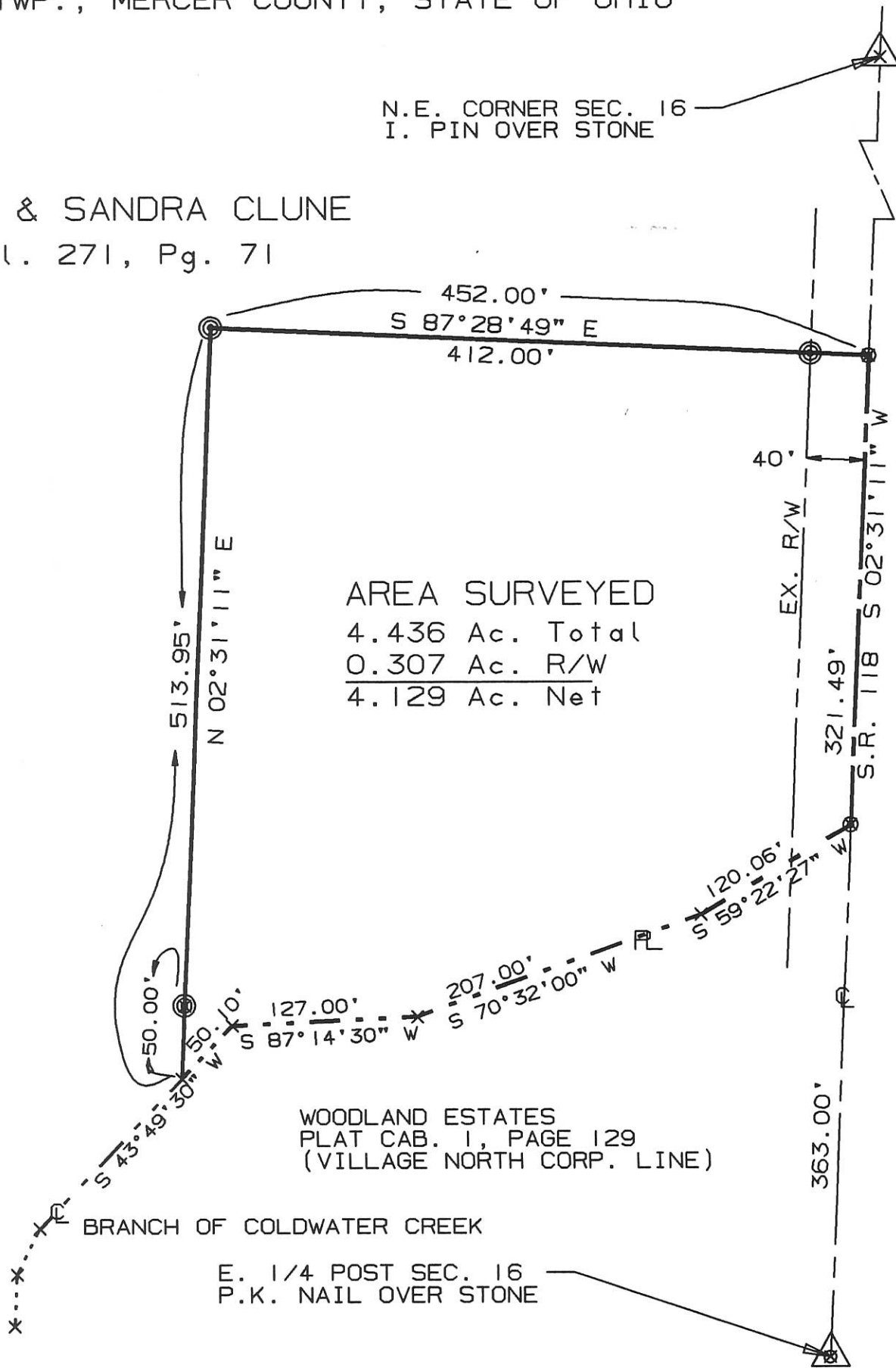

AREA SURVEYED
 4.436 Ac. Total
 0.307 Ac. R/W
 4.129 Ac. Net

WOODLAND ESTATES
 PLAT CAB. 1, PAGE 129
 (VILLAGE NORTH CORP. LINE)

BRANCH OF COLDWATER CREEK

E. 1/4 POST SEC. 16
P.K. NAIL OVER STONE

SURVEYED BY: Eric C. Thomas
 ERIC C THOMAS REG. SURVEYOR #7236
 DATE: 07-27-95

⊙ = I. PIN SET
 ⊙ = P.K. NAIL SET

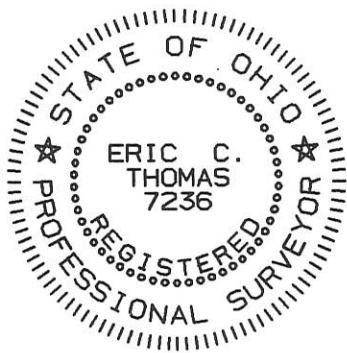

References: RECORDED PLAT OF WOODLAND
 ESTATES IN THE VILLAGE OF ST. HENRY
 PLAT CAB. 1, PAGE 129 DATED 5-16-90

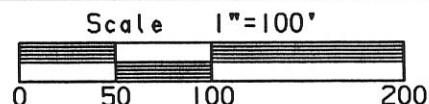

Part of N.E. 1/4 Sec. 16 T7-S R2-E Granville Twp., MERCER Co., OHIO
 GRANTOR: L. CLUNE DEEDS: Vol. 271 Pg. 71 AREA RETAINED _____ Ac.
 GRANTEE: _____ AREA: 4.436 Ac.

APPROVALS:	_____	_____	_____	_____
AGENCY:	BD. OF HEALTH	Co. San. Eng.	Co. Engineer	PERMANENT PARCEL No.
DATE				

VACATION OF EASEMENT ON LOT No. 1 & LOT No. 2 OF WOODLAND ESTATES FOR LINUS CLUNE

LOCATED IN THE N.E. 1/4 OF SEC. 16, T-7-S, R-2-E, GRANVILLE TWP., VILLAGE OF ST. HENRY, MERCER CO., OHIO

11-16-276-005-100 # 001

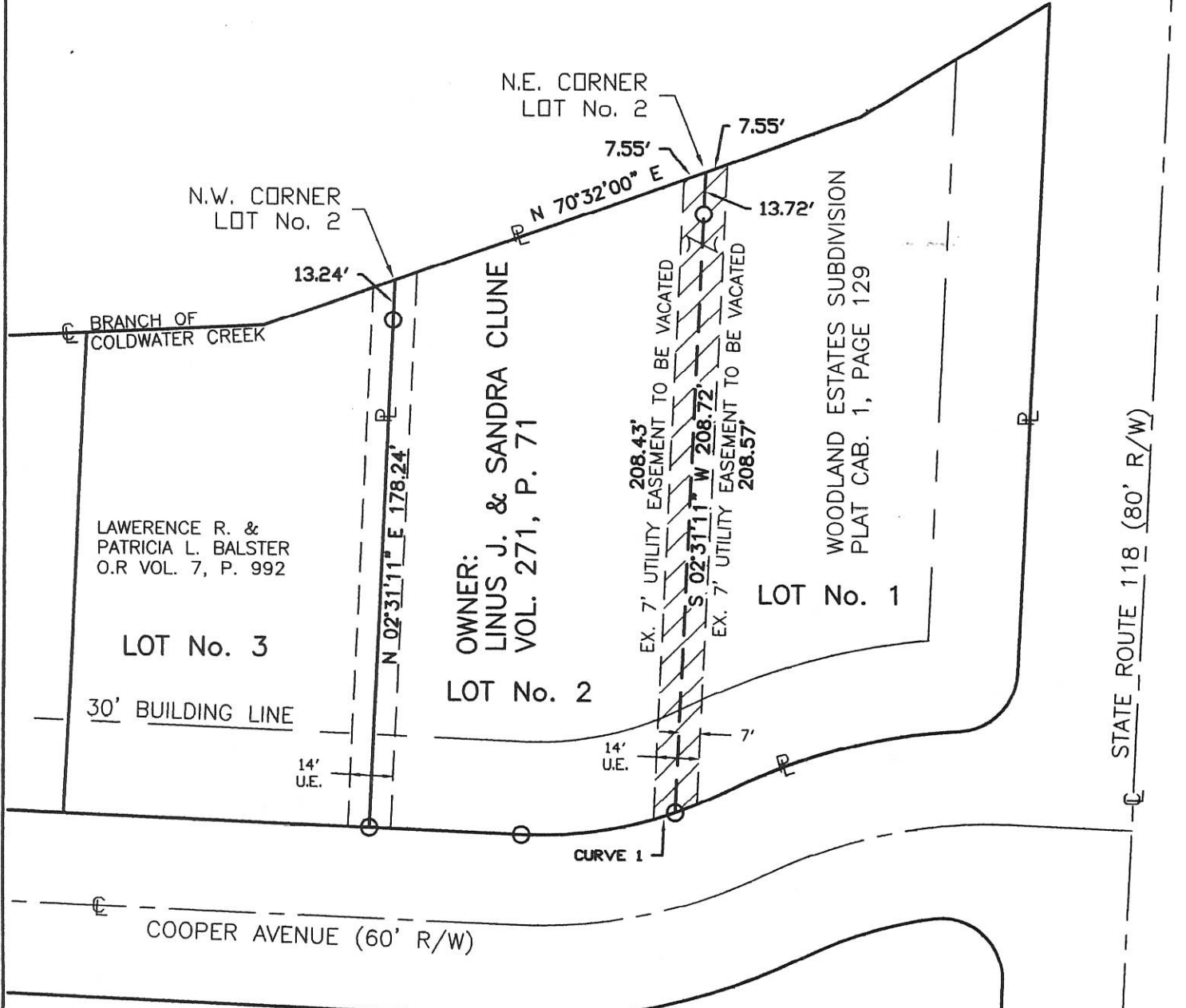

CURVE "1" DATA		
RADIUS	ARC LENGTH	CHORD
138.90'	51.27	S81°37'24"W 50.92'

NOTE: THE INTENT OF THIS EASEMENT VACATION IS TO COMBINE LOT No. 1 & LOT No. 2 TO CREATE ONE NEW BUILDING LOT.

ACCEPTANCE
THE VILLAGE OF ST. HENRY HEREBY ACCEPTS THE VACATION OF THE FOURTEEN FOOT UTILITY EASEMENT AS SHOWN ON THIS PLAT.

Donald A. Hess
VILLAGE ADMINISTRATOR - DON HESS

Surveyed By: *Eric C. Thomas*
Eric C. Thomas Reg. Surveyor No. 7236
Date: 08-09-04

LEGEND
○ Iron Pin Found



References: PLAT OF WOODLAND ESTATES, RECORDED IN PLAT CAB. No. 1, Pg. 129.	Scale: 1" = 50'
Part of N.E. 1/4 Sec. 16 T-7-S R-2-E GRANVILLE Twp., Mercer Co., OH	
Grantor: _____ Deeds: _____ Area Retained: _____ Ac.	
Grantee: _____ Area: _____ Ac.	
Approvals: Agency: Bd. of Health Date: _____	Co. San. Eng _____ Co. Engineer _____ Permanent Parcel No. _____

SURVEY OF A (2) 1.550 AC. TRACTS FOR LINUS CLUNE
LOCATED IN THE N.E. 1/4 OF SEC. 16, T-7-S, R-2-E,
GRANVILLE TWP., MERCER COUNTY, STATE OF OHIO

N.E. CORNER SEC. 16
I. PIN OVER STONE

PAUL BROEING
VOL. 327, PG. 540

FENCE POST

EX. CONCRETE
R/W MONUMENTS
@ 30' & 40'

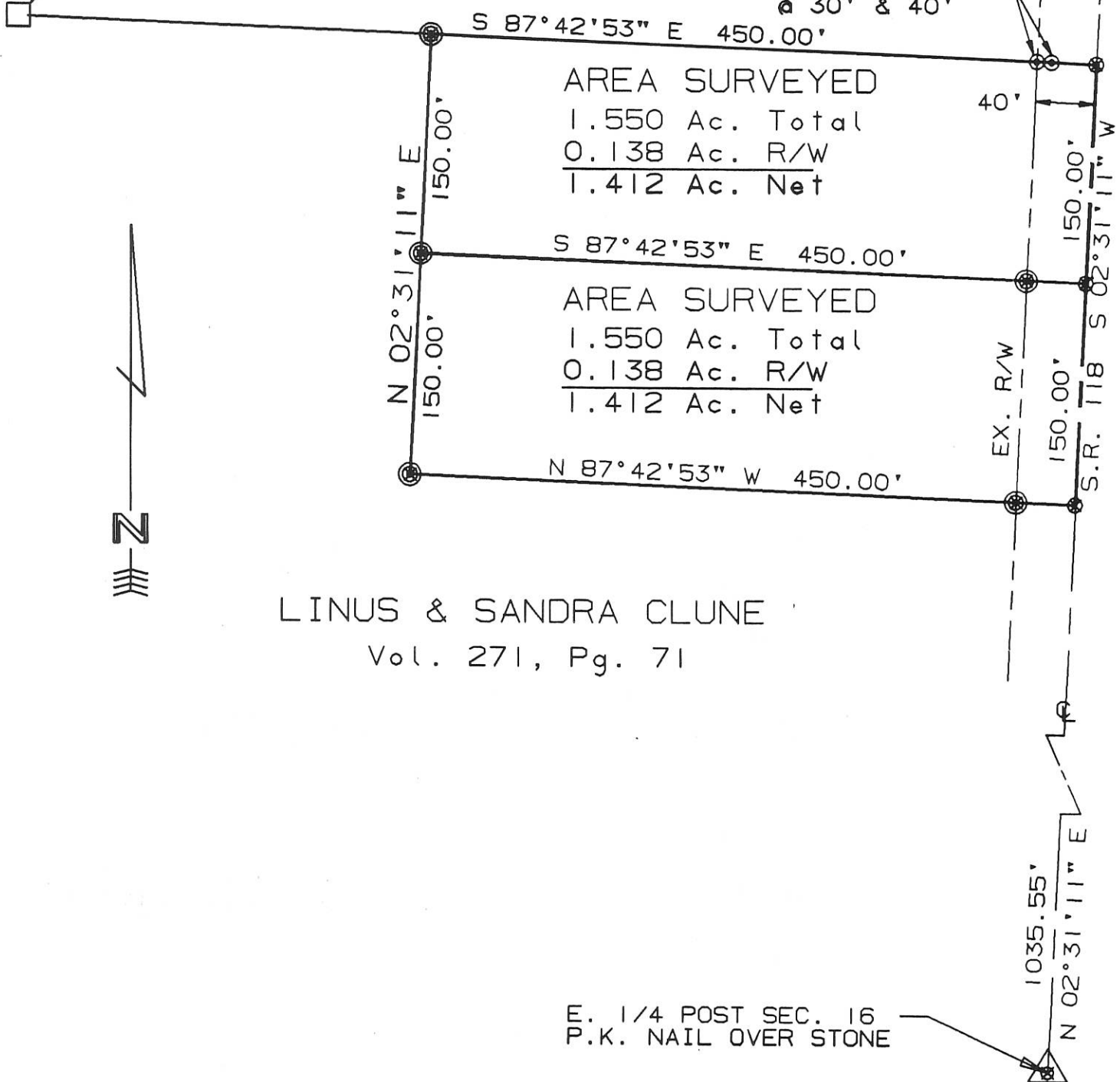

AREA SURVEYED
 1.550 Ac. Total
 0.138 Ac. R/W
 1.412 Ac. Net

AREA SURVEYED
 1.550 Ac. Total
 0.138 Ac. R/W
 1.412 Ac. Net

LINUS & SANDRA CLUNE
 Vol. 271, Pg. 71

E. 1/4 POST SEC. 16
 P.K. NAIL OVER STONE

SURVEYED BY: Eric C. Thomas
 ERIC C THOMAS REG. SURVEYOR #7236
 DATE: 10-23-95

⊗ = I. PIN SET
 ⊙ = P.K. NAIL SET

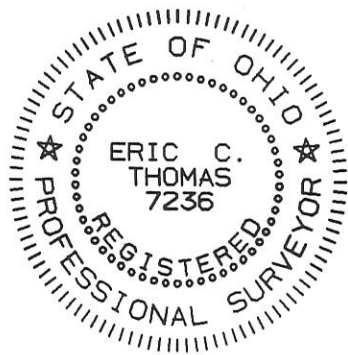

References: RECORDED PLAT OF WOODLAND ESTATES IN THE VILLAGE OF ST. HENRY PLAT CAB. 1, PAGE 129 DATED 5-16-90		Scale 1"=100' 	
Part of N.E. 1/4 Sec. 16 T7-S R2-E Granville Twp., MERCER Co., OHIO			
GRANTOR: <u>L. CLUNE</u> DEEDS: Vol. 271 Pg. 71 AREA RETAINED ____ Ac.			
GRANTEE: _____ AREA: <u>1.550</u> Ac.			
APPROVALS:	_____	_____	_____
AGENCY:	BD. OF HEALTH	Co. San. Eng.	Co. Engineer
DATE	_____	_____	PERMANENT PARCEL No. _____

1116276007 11-16B

SURVEY OF A 0.200 AC. TRACT FOR LINUS CLUNE
 LOCATED IN THE N.E. 1/4 OF SEC. 16, T-7-S, R-2-E,
 GRANVILLE TWP., MERCER COUNTY, STATE OF OHIO

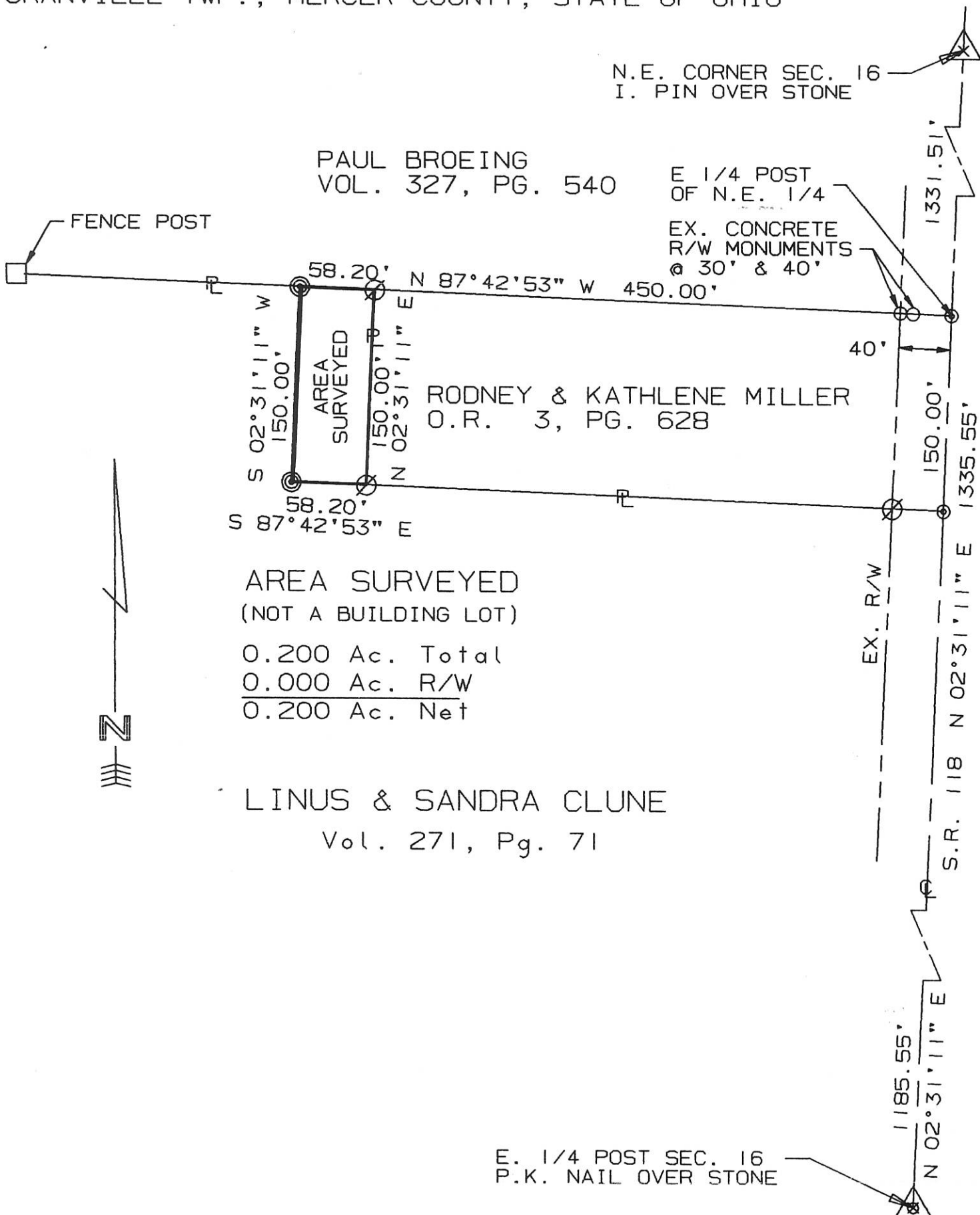

PAUL BROEING
 VOL. 327, PG. 540

E 1/4 POST
 OF N.E. 1/4
 EX. CONCRETE
 R/W MONUMENTS
 @ 30' & 40'

RODNEY & KATHLENE MILLER
 O.R. 3, PG. 628

AREA SURVEYED
 (NOT A BUILDING LOT)
 0.200 Ac. Total
 0.000 Ac. R/W
 0.200 Ac. Net

LINUS & SANDRA CLUNE
 Vol. 271, Pg. 71

E. 1/4 POST SEC. 16
 P.K. NAIL OVER STONE

SURVEYED BY: Eric C. Thomas
 ERIC C THOMAS REG. SURVEYOR #7236
 DATE: 03-15-97

- ⊘ = I. PIN FOUND
- ⊙ = I. PIN SET
- ⊗ = P.K. NAIL FOUND



References: PREVIOUS SURVEY IN THIS AREA FOR LINUS CLUNE BY THIS SURVEYOR DATED 10-23-95		Scale 1"=100' 0 50 100 200	
Part of N.E. 1/4 Sec. 16 T7-S R2-E Granville Twp., MERCER Co., OHIO			
GRANTOR: L. CLUNE DEEDS: Vol. 271 Pg. 71 AREA RETAINED ____ Ac.			
GRANTEE: _____ AREA: 0.200 Ac.			
APPROVALS:	AGENCY: BD. OF HEALTH	Co. San. Eng.	Co. Engineer
DATE			PERMANENT PARCEL No.

UTILITY OWNERS	
TYPE	NAME AND ADDRESS
STREETS AND STORM SEWER	VILLAGE OF ST. HENRY 371 N. LINN STREET ST. HENRY, OHIO 45883 419-678-4030 ATTN: RON GELHAUS
ELECTRIC	DAYTON POWER & LIGHT 1900 DRYDEN ROAD DAYTON, OHIO 45439 937-331-4521 ATTN: WILLIAM GOURLEY
TELEPHONE/ CABLE	HOMETOWN CABLE 305 EAST MAIN STREET COLDWATER, OHIO 45828 567-644-5795 ATTN: DON THOMPSON
TELEPHONE/ CABLE	WABASH MUTUAL TELEPHONE 6670 WABASH ROAD CELINA, OHIO 45822 ATTN: MIKE BOLEY
TELEPHONE/ CABLE	FRONTIER COMMUNICATIONS 301 GRAND LAKE ROAD CELINA, OHIO 45822 ATTN: DAVE FRITZ
GAS	ANR PIPELINE COMPANY 6222 N. COUNTY ROAD 300 WEST SULPHUR SPRINGS, IN 47388 765-533-4609 ATTN: DAVID MATTIX
GAS	DOMINION EAST OHIO GAS 150 S. JACKSON STREET LIMA, OHIO 45801 419-226-4829 ATTN: BRIAN HOLDEN

NOTE:
THE LOCATION OF THE UNDERGROUND UTILITIES SHOWN ON THE PLANS ARE OBTAINED FROM THE OWNERS OF THE UTILITIES AS REQUIRED BY SECTION 153.64 O.R.C.

RIGHT-OF-WAY LEGEND SHEET

TURN LANE IMPROVEMENTS ON SR 118

VILLAGE OF ST. HENRY GRANVILLE TOWNSHIP MERCER COUNTY, OHIO SEC. 15 & 16, T 7 S, R 2 E

PROJECT DESCRIPTION

THIS PROJECT WILL CONSIST OF THE WIDENING SR 118 TO INCLUDE A NEW LEFT TURN LANE INTO THE PROPOSED MERCER LANDMARK SITE ON AND NEW RIGHT TURN LANES INTO THE PROPOSED MERCER LANDMARK SITE AND ON TO CARTHAGENA ROAD.

PROJECT CONTROL

STATE PLANE GRID OHIO NORTH, NAD 83 CORS 2011 ADJUSTMENT, ODOT VRS CORS NETWORK, GEOID 12A, PROJECT ADJUSTMENT FACTOR 1.00003986420587.

PLANS PREPARED BY:

FIRM NAME: CHOICE ONE ENGINEERING

PLANS PREPARED BY: BRIAN H. BARHORST

FIELD REVIEW BY: BRIAN H. BARHORST
DATE COMPLETED: 03-26-2018



OWNERSHIP VERIFIED BY: WESLEY D. GOUBEAU
DATE COMPLETED: 05-22-2018

DATE COMPLETED: 05/22/2018

INDEX OF SHEETS:

LEGEND SHEET	1
CENTERLINE SURVEY PLAT	2
PROPERTY MAP	3
SUMMARY SHEET	4
RIGHT OF WAY PLAN	5-7

STRUCTURE KEY

-  COMMERCIAL
-  RESIDENTIAL
-  RESIDENTIAL OUT BUILDING

LEGEND

- SH = STANDARD HIGHWAY EASEMENT
- T = TEMPORARY EASEMENT

I, WESLEY D. GOUBEAU, P.S. 8254, HAVE CONDUCTED A SURVEY OF THE EXISTING CONDITIONS FOR THE MERCER COUNTY COMMISSIONERS IN MARCH, 2018. THE RESULTS OF THAT SURVEY ARE CONTAINED HEREIN.

THE HORIZONTAL COORDINATES EXPRESSED HEREIN ARE BASED ON NAD 83 CORS 2011 ADJUSTMENT, OHIO NORTH ZONE. THE PROJECT ADJUSTMENT FACTOR USED FOR THIS PROJECT IS 1.00003986420587.

I HAVE DETERMINED THE LOCATIONS OF THE EXISTING PROPERTY LINES FOR PROPERTY TAKES CONTAINED HEREIN. I HAVE CALCULATED THE PROPOSED PROPERTY LINES, GROSS TAKE, PRESENT ROADWAY OCCUPIED (PRO), NET TAKE AND NET RESIDUES, AS WELL AS PREPARED THE LEGAL DESCRIPTIONS NECESSARY TO ACQUIRE THESE PARCELS AS SHOWN HEREIN.

AS A PART OF THIS PROJECT, I HAVE SET MONUMENTS AT THE PROPOSED PROPERTY CORNERS, SECTION CORNERS AND OTHER POINTS AS SHOWN HEREIN. HOWEVER, ITEM 604 MONUMENT ASSEMBLIES, ITEM 604 REFERENCE MONUMENTS AN CENTERLINE MONUMENTS SHALL BE INSTALLED BY THE CONSTRUCTION CONTRACTOR AS SPECIFIED IN THE PLANS. ALL CENTERLINE MONUMENTS AND RIGHT-OF-WAY MONUMENTS SET AND/OR RESET BY THE CONTRACTOR'S SURVEYOR WILL INCLUDE A CAP AS PER STANDARD CONSTRUCTION DRAWING RM-1.1 AND BEAR THE SURVEYOR'S OHIO REGISTRATION NUMBER AND/OR NAME OR COMPANY NAME. THIS WORK WILL BE DONE IN ACCORDANCE WITH OAC 4733-37 AS CITED BELOW.

ALL OF MY WORK CONTAINED HEREIN WAS CONDUCTED IN ACCORDANCE WITH OHIO ADMINISTRATIVE CODE 4733-37 COMMONLY KNOWN AS MINIMUM STANDARDS FOR BOUNDARY SURVEY IN THE STATE OF OHIO UNLESS SO NOTED.

THE WORDS I AND MY AS USED HEREIN ARE TO MEAN EITHER MYSELF OR SOMEONE WORKING FOR ME UNDER MY DIRECT CONTROL OR SUPERVISION.

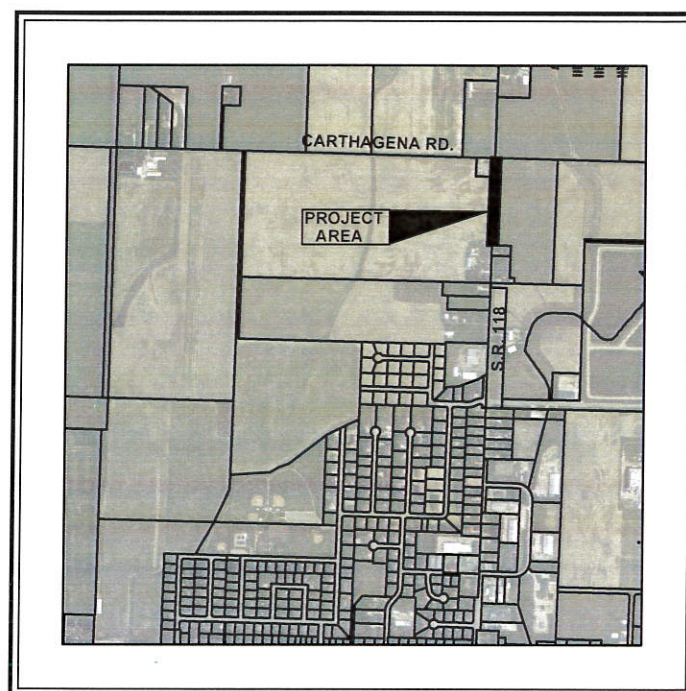

CONVENTIONAL SIGNS

- COUNTY LINE _____
- TOWNSHIP LINE _____
- SECTION LINE _____
- CORPORATION LINE _____
- FENCE LINE (EXISTING) -X-X- (PROPOSED) -X-X-
- CENTER LINE _____
- TREES (TO BE REMOVED) X X
- UTILITY POLES: TELEPHONE P, POWER P, LIGHT L
- LIMITED ACCESS (ONLY) LA
- RIGHT OF WAY (ONLY) R/W
- LIMITED ACCESS & RIGHT OF WAY LA-R/W
- EXISTING RIGHT OF WAY Ex. R/W
- PROPERTY LINE (IN EXISTING FENCE) -X-X-
- RAILROAD [Symbol]
- GUARDRAIL (EXISTING) -o-o- (PROPOSED) -o-o-
- WORK LIMITS C/L _____ C/L _____
- PROP. STANDARD HIGHWAY ESMT. SH
- PROP. TEMPORARY EASEMENT TMP

PLAN PREPARED BY:



440 E. HOEWISHER ROAD | SIDNEY, OHIO 45365 | 937.497.0200
203 W. LOVELAND AVENUE | LOVELAND, OHIO 45140 | 513.239.8554
607 N. MERIDIAN STREET | PORTLAND, INDIANA 47371 | 260.766.2500
www.CHOICEONEENGINEERING.com

FEDERAL PROJECT NO.
N/A

PID NO.
N/A

R/W DESIGNER
BHB
R/W REVIEWER
WDG

RIGHT OF WAY
LEGEND SHEET

TURN LANE IMPROVEMENTS ON SR 118

1 / 7

32
38

By _____
SURVEYOR No. 8254 DATE _____

11-15-101-001
11-16-201-002

APPROVED FOR CENTERLINE DATA ONLY

FILE # _____

MERCER COUNTY ENGINEER _____

DATE _____

TURN LANE IMPROVEMENTS ON SR 118

VILLAGE OF ST. HENRY
 GRANVILLE TOWNSHIP
 MERCER COUNTY, OHIO
 SEC. 15 & 16, T 7 S, R 2 E

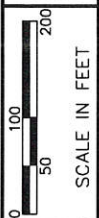

PID NO. **N/A**

R/W DESIGNER: BHB
 R/W REVIEWER: WDC

CENTERLINE PLAT

TURN LANE IMPROVEMENTS ON SR 118

2 / 7

33
 38

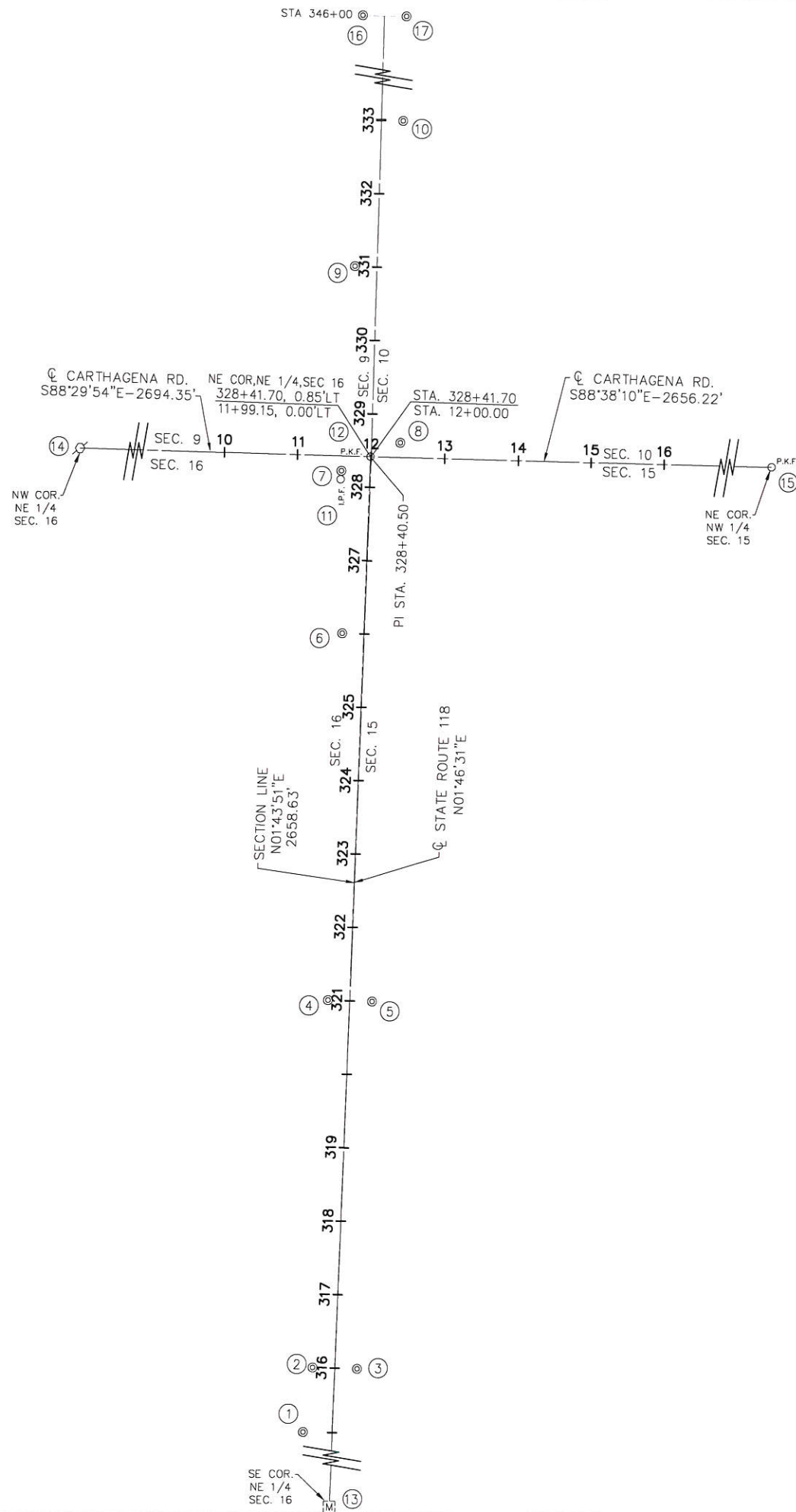

MONUMENT LEGEND

- I.P.F. IRON PIN FOUND
- ⊗ MAG SPIKE FOUND
- P.K.F. P.K. NAIL FOUND
- ⊙ P.F. IRON PIPE FOUND
- M.N.S. MAG NAIL SET
- I.P.S. 5/8" IRON PIN WITH CAP SET
- ⊙ CONCRETE R/W MONUMENT FOUND
- ⊚ MONUMENT BOX W/IP FOUND

BASIS FOR EX. R/W

THE EXISTING RIGHT-OF-WAY WIDTH WERE DETERMINED USING VARIOUS ROADWAY PLANS ON FILE AT ODOT DISTRICT 7 AS LISTED BELOW.

THE PROPOSED RIGHT-OF-WAY SHALL BE REFERENCED TO THE CENTERLINE OF SURVEY.

PERTINENT INFORMATION

MERCER COUNTY SH 660-1938
 MERCER COUNTY COUNTY SECTION CORNER NOTES
 ODOT DISTRICT 7 SECTION CORNER NOTES
 DEEDS AS SHOWN ON R/W DETAIL SHEETS

BASIS FOR BEARINGS

THE BEARING OF N01°46'31"E ALONG THE CENTERLINE OF STATE ROUTE 118 IS BASED ON NAD 83 CORS 2011 ADJUSTMENT, GEOID 12A, OHIO NORTH ZONE, ODOT VRS CORS NETWORK. THE PROJECT ADJUSTMENT FACTOR USED FOR THIS PROJECT IS 1.00003986420587.

PLAN PREPARED BY:



440 E. HOEWISHER ROAD | SIDNEY, OHIO 45365 | 937.497.0200
 203 W. LOVELAND AVENUE | LOVELAND, OHIO 45140 | 513.239.8554
 607 N. MERIDIAN STREET | PORTLAND, INDIANA 47371 | 260.766.2500
 www.CHOICEONEENGINEERING.com

NO.	ROADWAY	STATION	DISTANCE FROM C OF SURVEY		DESCRIPTION	GROUND COORDINATES	
			LEFT	RIGHT		NORTHING	EASTING
1	ST. RT. 118	315+12.06	39.56'		CONC. R/W MONUMENT FD.	286194.7490	1375864.5310
2	ST. RT. 118	315+99.93	30.05'		CONC. R/W MONUMENT FD.	286282.2840	1375876.7550
3	ST. RT. 118	316+00.07		30.05'	CONC. R/W MONUMENT FD.	286280.5550	1375936.8350
4	ST. RT. 118	320+99.88	29.94'		CONC. R/W MONUMENT FD.	286781.9850	1375892.3530
5	ST. RT. 118	320+99.91		30.06'	CONC. R/W MONUMENT FD.	286780.1630	1375952.3230
6	ST. RT. 118	325+99.85	30.00'		CONC. R/W MONUMENT FD.	287281.7210	1375907.7820
7	ST. RT. 118	328+21.05	39.76'		CONC. R/W MONUMENT FD.	287503.1170	1375904.8790
8	ST. RT. 118	328+61.75		39.31'	CONC. R/W MONUMENT FD.	287541.5690	1375985.0680
9	ST. RT. 118	331+00.38	30.18'		CONC. R/W MONUMENT FD.	287781.8880	1375921.6240
10	ST. RT. 118	333+00.28		29.84'	CONC. R/W MONUMENT FD.	287980.1990	1375986.6770
11	ST. RT. 118	328+09.52	40.47'		IRON PIN FD.	287491.6080	1375903.8070
12	ST. RT. 118	328+41.70	0.84'		P.K. NAIL FD.	287522.5470	1375944.4140
13	ST. RT. 118				MON. BOX W/ IRON PIN FD.	284864.1250	1375854.1170
14	CARTHAGENA RD.				MAG SPIKE FD.	287593.1510	1373250.9870
15	CARTHAGENA RD.				P.K. NAIL FD.	287459.3210	1375999.8770
16	ST. RT. 118	346+00.12	30.04'		CONC. R/W MONUMENT FD.	289280.8240	1375959.6570
17	ST. RT. 118	346+00.12		30.04'	CONC. R/W MONUMENT FD.	289279.9460	1376019.7340

I, WESLEY D. GOUBEAU, P.S. 8254, HAVE CONDUCTED A SURVEY OF THE EXISTING CONDITIONS FOR THE MERCER COUNTY COMMISSIONERS IN MARCH, 2018. THE RESULTS OF THAT SURVEY ARE CONTAINED HEREIN.

THE HORIZONTAL COORDINATES EXPRESSED HEREIN ARE BASED ON NAD 83 CORS 2011 ADJUSTMENT, OHIO NORTH ZONE. THE PROJECT ADJUSTMENT FACTOR USED FOR THIS PROJECT IS 1.00003986420587.

I HAVE DETERMINED THE LOCATIONS OF THE EXISTING PROPERTY LINES FOR PROPERTY TAKES CONTAINED HEREIN. I HAVE CALCULATED THE PROPOSED PROPERTY LINES, GROSS TAKE, PRESENT ROADWAY OCCUPIED (PRO), NET TAKE AND NET RESIDUES, AS WELL AS PREPARED THE LEGAL DESCRIPTIONS NECESSARY TO ACQUIRE THESE PARCELS AS SHOWN HEREIN.

AS A PART OF THIS PROJECT, I HAVE SET MONUMENTS AT THE PROPOSED PROPERTY CORNERS, SECTION CORNERS AND OTHER POINTS AS SHOWN HEREIN. HOWEVER, ITEM 604 MONUMENT ASSEMBLIES, ITEM 604 REFERENCE MONUMENTS AN CENTERLINE MONUMENTS SHALL BE INSTALLED BY THE CONSTRUCTION CONTRACTOR AS SPECIFIED IN THE PLANS. ALL CENTERLINE MONUMENTS AND RIGHT-OF-WAY MONUMENTS SET AND/OR RESET BY THE CONTRACTOR'S SURVEYOR WILL INCLUDE A CAP AS PER STANDARD CONSTRUCTION DRAWING RM-1.1 AND BEAR THE SURVEYOR'S OHIO REGISTRATION NUMBER AND/OR NAME OR COMPANY NAME. THIS WORK WILL BE DONE IN ACCORDANCE WITH OAC 4733-37 AS CITED BELOW.

ALL OF MY WORK CONTAINED HEREIN WAS CONDUCTED IN ACCORDANCE WITH OHIO ADMINISTRATIVE CODE 4733-37 COMMONLY KNOWN AS MINIMUM STANDARDS FOR BOUNDARY SURVEY IN THE STATE OF OHIO UNLESS SO NOTED.

THE WORDS I AND MY AS USED HEREIN ARE TO MEAN EITHER MYSELF OR SOMEONE WORKING FOR ME UNDER MY DIRECT CONTROL OR SUPERVISION.

By _____
 SURVEYOR No. 8254 DATE _____

REV.	DATE	DESCRIPTION

DATE OF COMPLETION 05/22/2018

TURN LANE IMPROVEMENTS ON SR 118

VILLAGE OF ST. HENRY
 GRANVILLE TOWNSHIP
 MERCER COUNTY, OHIO
 SEC. 15 & 16, T 7 S, R 2 E

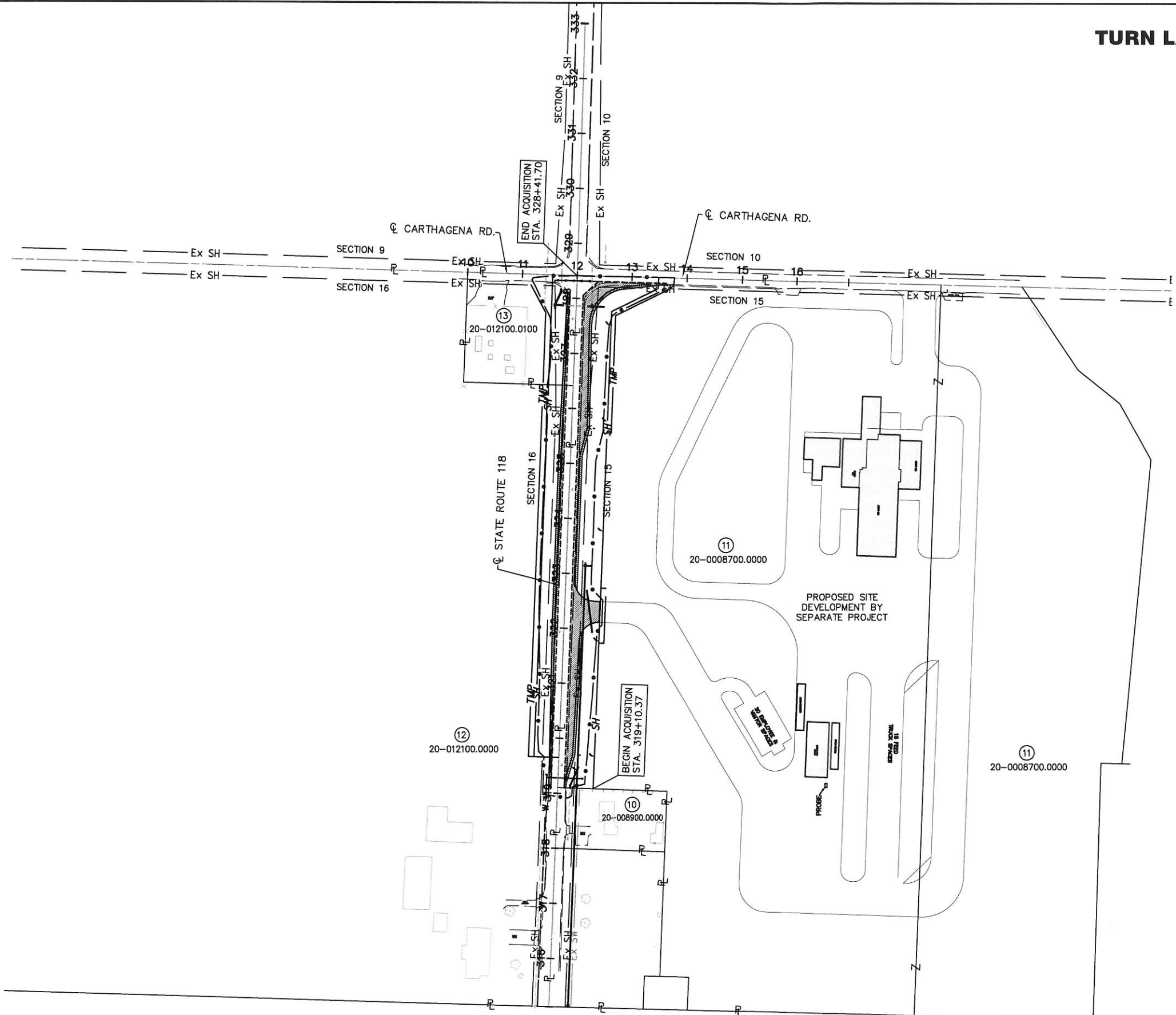

- 10 JANE F. HEITKAMP (1/4 INTEREST)
 DANIEL J. HARTINGS (1/4 INTEREST)
 DEBRA H. FREEMAN (1/4 INTEREST)
 KAREN A. EILERMAN (1/4 INTEREST)
- 11 MPS FEED, LLC
- 12 TODD M. BROERING AND MOLLY R. BROERING
- 13 ANR PIPELINE COMPANY

- COMMERCIAL
- RESIDENTIAL
- RESIDENTIAL OUT BUILDING

PID NO. **N/A**

R/W DESIGNER: BHB
 R/W REVIEWER: WDG

PROPERTY MAP

TURN LANE IMPROVEMENTS ON SR 118

3 / 7

REV.	DATE	DESCRIPTION

34
38

DATE OF COMPLETION: 05/08/2018

TOTAL NUMBER OF :

3 OWNERSHIPS
7 PARCELS
0 TOTAL TAKES

0 OWNERSHIPS WITH STRUCTURES INVOLVED

GRANTEE:

ALL RIGHT-OF-WAY ACQUIRED IN THE NAME OF THE BOARD OF MERCER COUNTY COMMISSIONERS UNLESS OTHERWISE SHOWN.

NET RESIDUE = RECORD AREA - TOTAL PRO - NET TAKE
ALL AREAS IN ACRES

SUMMARY SHEET 1 OF 1

* DENOTES RIGHT OF WAY ENCROACHMENT

PARCEL NO.	OWNER	SHEET NO.	OWNERS RECORD INSTRUMENT	AUDITOR'S PARCEL	RECORD AREA	TOTAL P.R.O.	GROSS TAKE	P.R.O. IN TAKE	NET TAKE	STRUC-TURE	NET RESIDUE		TYPE FUND	REMARKS AND PERSONALTY	AS ACQUIRED	
											LEFT	RIGHT			BOOK	PAGE
1-9	NOT USED												LOCAL	NO TAKE		
10	JANE F. HEITKAMP (1/4 INTEREST) DANIEL J. HARTINGS (1/4 INTEREST) DEBRA H. FREEMAN (1/4 INTEREST) KAREN A. EILERMAN (1/4 INTEREST)	5	OR 206/660	20-008900.0000	0.5					NO				NO TAKE		
11SH	MPS FEED, LLC	5-7	INSTR. 201800001757	20-008700.0000	18.38	0.969	1.481	0.732	0.749	NO		16.662				
11T1		6				0.000	0.020	0.000	0.020	NO				GRADING		
11T2		7				0.000	0.061	0.000	0.061	NO				GRADING		
12SH	TODD M. BROERING AND MOLLY R. BROERING	5-7	INSTR. 200900008146	20-012100.0000	78.0818	1.902	0.692	0.460	0.232	NO		75.720				
12T		5-7				0.000	0.155	0.000	0.155	NO				GRADING		
13SH	ANR PIPELINE COMPANY	7	DB 311/864	20-012100.0100	0.9182	0.236	0.203	0.166	0.037	NO		0.645				
13T		7				0.000	0.057	0.000	0.057	NO			LOCAL	GRADING		

FEDERAL PROJECT NO. N/A

STATE JOB NO. N/A

PID NO. N/A

R/W DESIGNER BHB
R/W REVIEWER WDG

SUMMARY OF ADDITIONAL RIGHT-OF-WAY PARCELS 10-13

TURN LANE IMPROVEMENTS ON SR 118

NOTE: UNDER NO CIRCUMSTANCES ARE TEMPORARY EASEMENTS ACQUIRED FOR THE PURPOSE OF STRUCTURE REMOVAL TO BE USED FOR STORAGE OF MATERIAL OR EQUIPMENT BY THE CONTRACTOR. UPON COMPLETION OF THE WORK REQUIRED FOR SUCH REMOVAL AND SUBSEQUENT RECLAMATION, THE EASEMENT SHALL BE VACATED IMMEDIATELY.

NOTE: ALL TEMPORARY PARCELS TO BE OF 12 MONTH DURATION FROM COMMENCEMENT OF CONSTRUCTION. (c) = CALCULATED AREA

LEGEND
SH = STANDARD HIGHWAY EASEMENT
T = TEMPORARY EASEMENT

REV.	DATE	DESCRIPTION
DATE OF COMPLETION		05/22/2018

TURN LANE IMPROVEMENTS ON SR 118

VILLAGE OF ST. HENRY
GRANVILLE TOWNSHIP
MERCER COUNTY, OHIO
SEC. 15 & 16, T 7 S, R 2 E

11-15-101-001
11-16-201-002



STATION/OFFSET CHART		
POINT	STATION	OFFSET
A	319+65.00	30.00' LT
B	319+65.00	45.00' LT

12
TODD M. BROERING AND
MOLLY R. BROERING
2885 ST. RT. 118
INSTR #200900008146
20-012100.0000
AGRICULTURAL

LINE CHART		
LINE	BEARING	DIST.
L1	N88°13'29"W	44.83'
L2	N88°13'29"W	10.00'

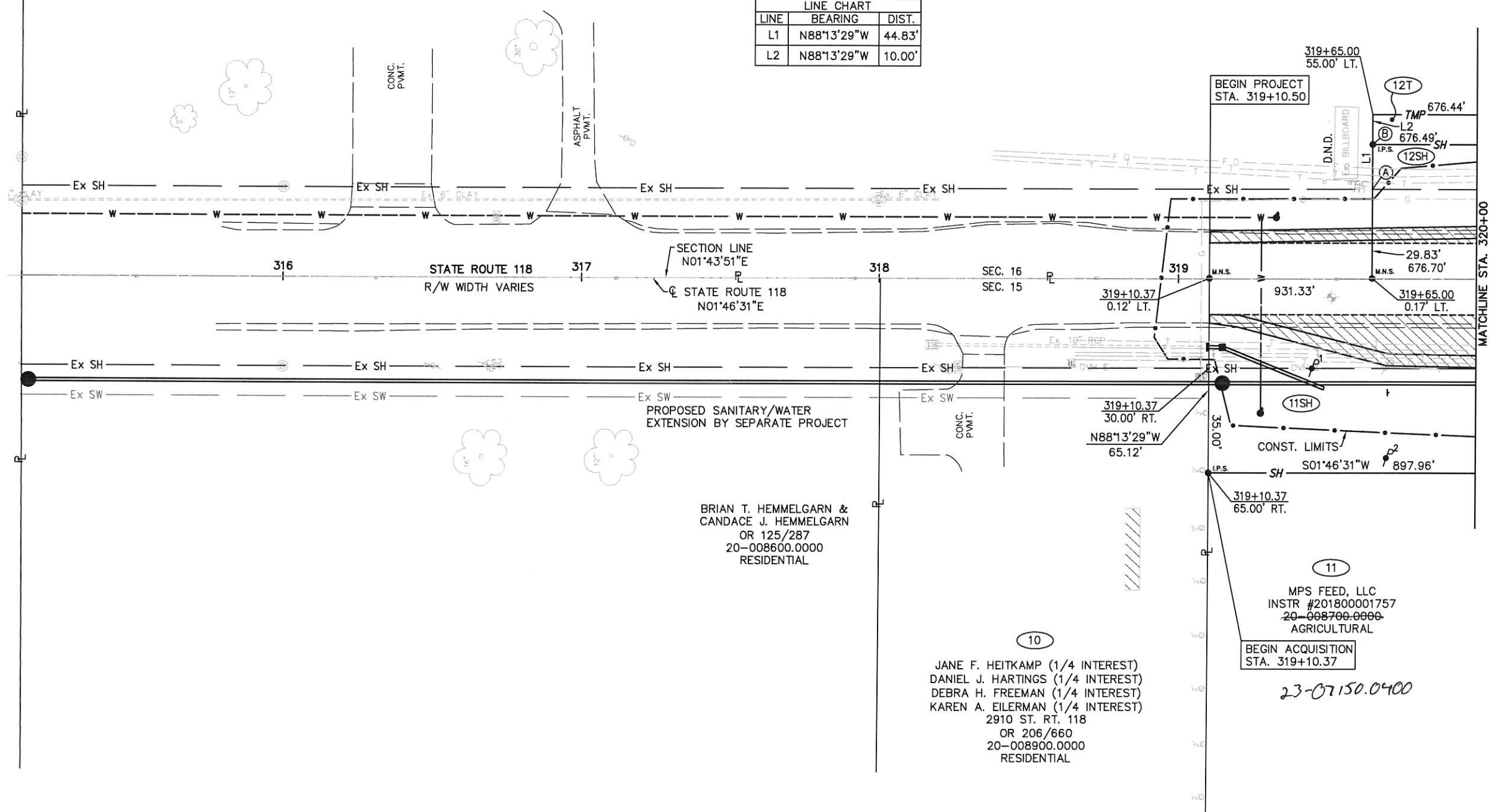

BRIAN T. HEMMELGARN &
CANDACE J. HEMMELGARN
OR 125/287
20-008600.0000
RESIDENTIAL

10
JANE F. HEITKAMP (1/4 INTEREST)
DANIEL J. HARTINGS (1/4 INTEREST)
DEBRA H. FREEMAN (1/4 INTEREST)
KAREN A. EILERMAN (1/4 INTEREST)
2910 ST. RT. 118
OR 206/660
20-008900.0000
RESIDENTIAL

11
MPS FEED, LLC
INSTR #201800001757
~~20-008700.0000~~
AGRICULTURAL
23-07150.0400

PID NO.
N/A

R/W DESIGNER
BHB
R/W REVIEWER
WDG

RIGHT OF WAY DETAIL SHEET
STA. 315+12.35 TO 320+00

TURN LANE IMPROVEMENTS ON SR 118

5 / 7

REV.	DATE	DESCRIPTION

36
38

DATE OF COMPLETION 05/22/2018

TURN LANE IMPROVEMENTS ON SR 118

VILLAGE OF ST. HENRY
GRANVILLE TOWNSHIP
MERCER COUNTY, OHIO
SEC. 15 & 16, T 7 S, R 2 E

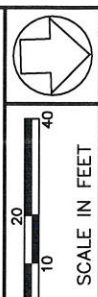

PID NO. **N/A**

R/W DESIGNER: BHB
R/W REVIEWER: WDG

RIGHT OF WAY DETAIL SHEET
STA. 320+00 TO 325+00

TURN LANE IMPROVEMENTS ON SR 118

(12)
 TODD M. BROERING AND
 MOLLY R. BROERING
 2885 ST. RT. 118
 INSTR #200900008146
 20-012100.0000
 AGRICULTURAL

(11)
 MPS FEED, LLC
 INSTR #201800001757
 20-008700.0000
 AGRICULTURAL
 23-07150.0000

PROPOSED DRIVE WITH
 SITE DEVELOPMENT BY
 SEPARATE PROJECT

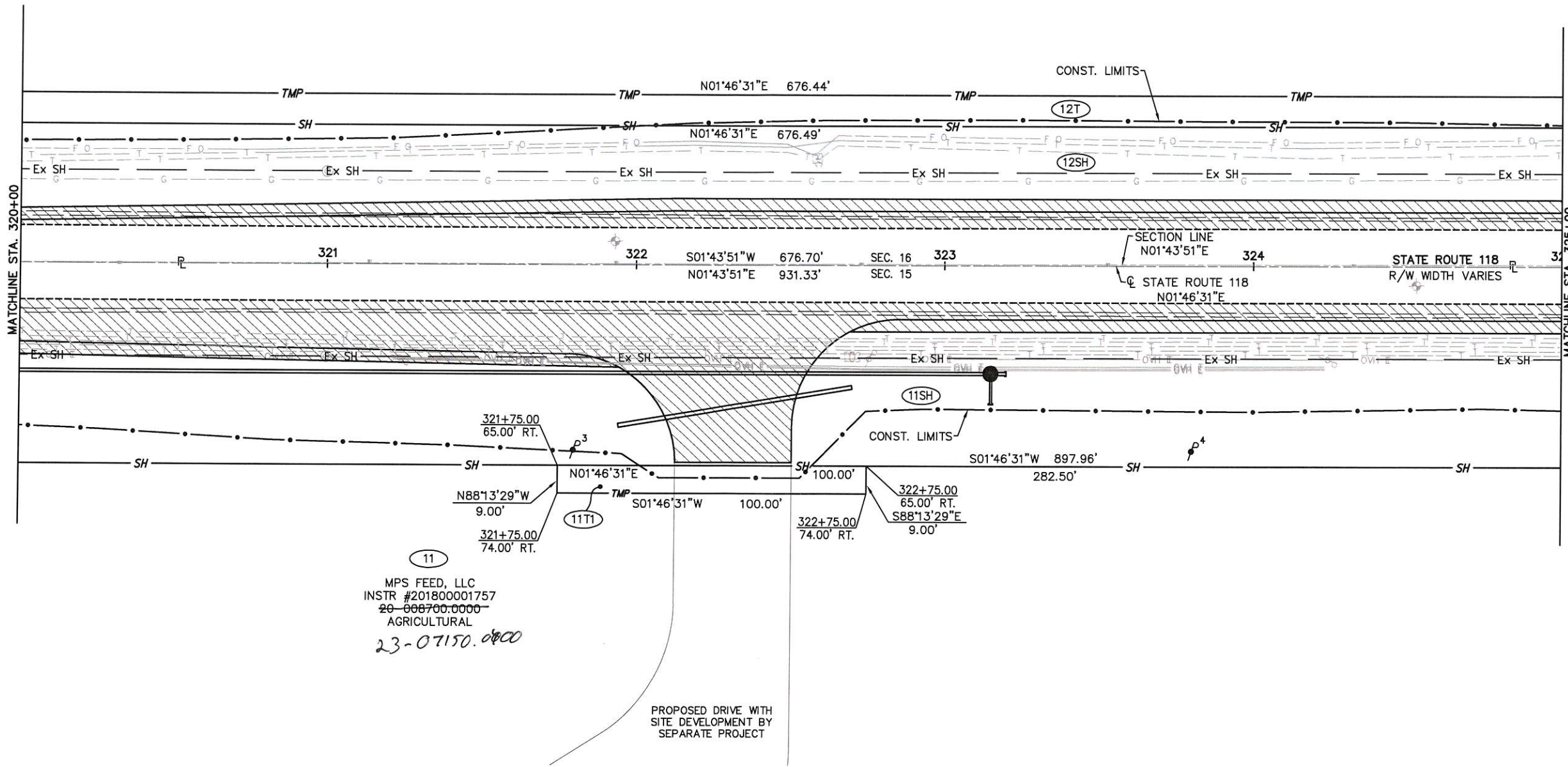

REV.	DATE	DESCRIPTION

DATE OF COMPLETION: 05/22/2018

TURN LANE IMPROVEMENTS ON SR 118

VILLAGE OF ST. HENRY
GRANVILLE TOWNSHIP
MERCER COUNTY, OHIO
SEC. 15 & 16, T 7 S, R 2 E

12
TODD M. BROERING AND
MOLLY R. BROERING
2885 ST. RT. 118
INSTR #200900008146
20-012100.0000
AGRICULTURAL

13
ANR PIPELINE COMPANY
DB 311/864
20-012100.0100
NATURAL GAS DISTRIBUTION

CRAIG BUSCHUR
INSTR #201700005622
20-001700.0200
RESIDENTIAL

VERENA L. EVERS &
DONALD F. EVERS, TRUSTEES
OR 68/952
20-002100.0000
AGRICULTURE

11
MPS FEED, LLC
INSTR #201800001757
20-008700.0000
AGRICULTURAL
23-07150.0400

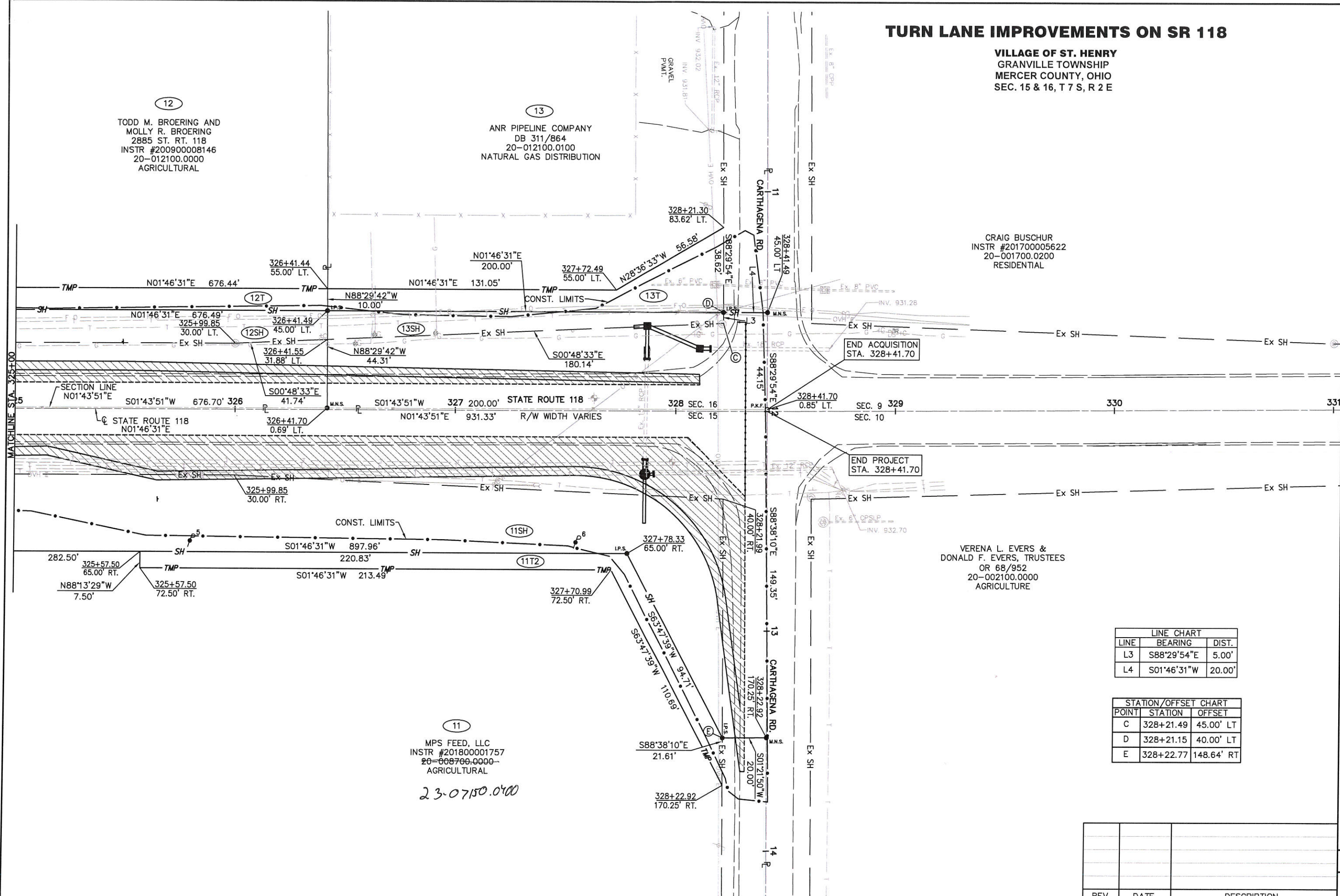



0 10 20 40
SCALE IN FEET

PID NO. **N/A**

R/W DESIGNER: BHB
R/W REVIEWER: WDG

RIGHT OF WAY DETAIL SHEET
STA. 325+00 TO 330+00

TURN LANE IMPROVEMENTS ON SR 118

7 / 7

REV.	DATE	DESCRIPTION
DATE OF COMPLETION		05/22/2018

38
38

SURVEY FOR LINUS J. AND SANDRA CLUNE

References:

- Northern Heights Subdivision-Instrument #201500005607.
- Woodland Estates-Plat Cabinet 1 Page 129.
- Walnut Grove Subdivision-Plat Cabinet 1 Page 341.
- Parkview Estates First Addition-Instrument #200600000913.
- Annexation Plat to the Village of St. Henry-Instrument #200500003307.
- Clune Survey by Eric C. Thomas PS #7236 in August of 1995.
- Clune Survey by Eric C. Thomas PS #7236 in October of 1995.
- State Highway Plans
- All Deeds on Record

Notes:

Area Surveyed is to be an "Add to" parcel only.

AREA SURVEYED
 0.500 TOTAL ACRES
 0.044 R/W ACRES
 0.456 NET ACRES

LINUS J. AND SANDRA CLUNE
 VOLUME 271 PAGE 71
 36.947 ACRES

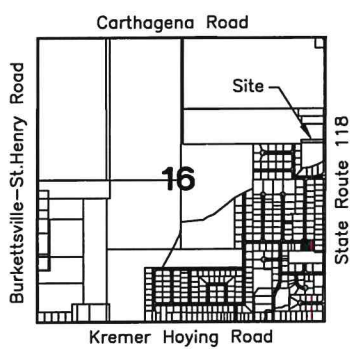
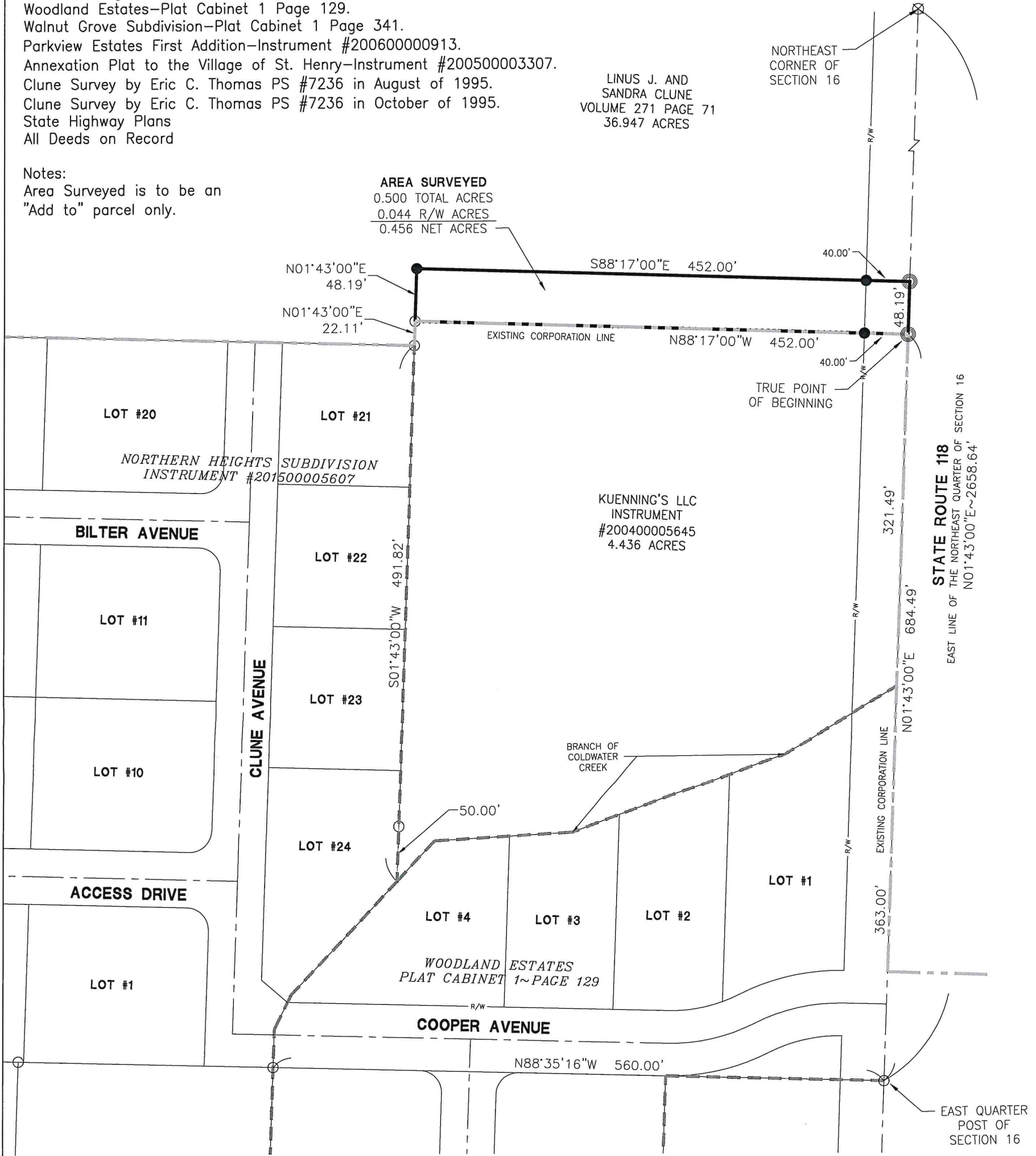

Surveyed By: *[Signature]*
 Craig W. Mescher Reg. Surveyor No. 8237

LEGEND

- ⊗ RR Spike Found
- Iron Pin Found
- Iron Pin Set
- ⊙ Mag Nail Set
- ⊗ Mag Nail Found
- Con Mon. Found
- △ Section Corner

Scale: 1" = 100'

PROJECT # 220808.88

ACCESS
 Engineering Solutions
 1200 IRMSCHER BLVD., SUITE B, CELINA, OH 45822
 www.accessengllc.com | 419-586-1430



Basis of Bearings:
 Mercer County Local Coordinate Datum.

State of: Ohio County: Mercer
 Township: Granville
 Sec.: NE 1/4 16 Town: 7S Range: 2E
 Deed Ref.: D.V. 271 Page 71
 Date Surveyed: October 1, 2020

SURVEY FOR LINUS J. AND SANDRA CLUNE

References:

- Northern Heights Subdivision-Instrument #201500005607.
- Woodland Estates-Plat Cabinet 1 Page 129.
- Walnut Grove Subdivision-Plat Cabinet 1 Page 341.
- Parkview Estates First Addition-Instrument #200600000913.
- Annexation Plat to the Village of St. Henry-Instrument #200500003307.
- Clune Survey by Eric C. Thomas PS #7236 in August of 1995.
- Clune Survey by Eric C. Thomas PS #7236 in October of 1995.
- State Highway Plans
- All Deeds on Record

Notes:

Area Surveyed is to be an "Add to" parcel only.

LINUS J. AND SANDRA CLUNE
VOLUME 271 PAGE 71
36.947 ACRES

AREA SURVEYED
0.238 TOTAL ACRES
0.021 R/W ACRES
0.217 NET ACRES

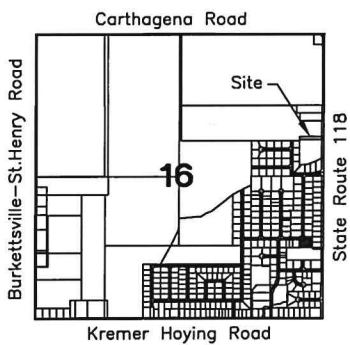
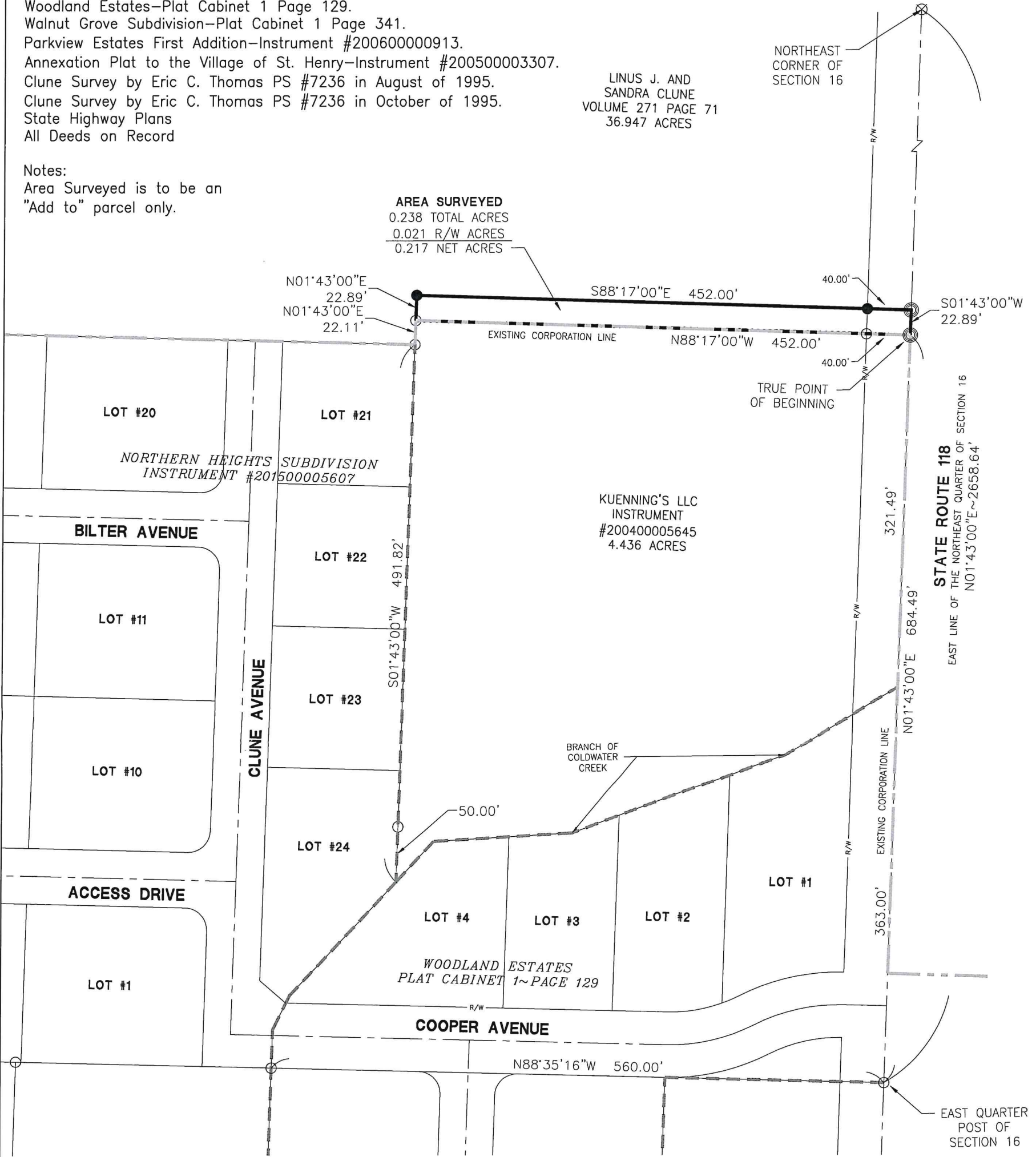

Surveyed By: 
 Craig W. Mescher Reg. Surveyor No. 8237

LEGEND

- ⊗ RR Spike Found
- Iron Pin Found
- Iron Pin Set
- ⊙ Mag Nail Set
- ⊗ Mag Nail Found
- Con Mon. Found
- △ Section Corner

Scale: 1" = 100'

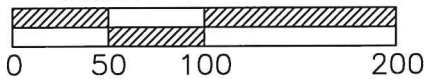

PROJECT # 220808.88



1200 IRMSCHER BLVD., SUITE B, CELINA, OH 45822
www.accessengllc.com | 419-586-1430



Basis of Bearings:
Mercer County Local Coordinate Datum.

State of: Ohio County: Mercer
 Township: Granville
 Sec.: NE 1/4 16 Town: 7S Range: 2E
 Deed Ref.: D.V. 271 Page 71
 Date Surveyed: October 1, 2020

SURVEY FOR LINUS J. AND SANDRA CLUNE

References:

Northern Heights Subdivision-Instrument #201500005607.
 Woodland Estates-Plat Cabinet 1 Page 129.
 Walnut Grove Subdivision-Plat Cabinet 1 Page 341.
 Parkview Estates First Addition-Instrument #200600000913.
 Annexation Plat to the Village of St. Henry-Instrument #200500003307.
 Clune Survey by Eric C. Thomas PS #7236 in August of 1995.
 Clune Survey by Eric C. Thomas PS #7236 in October of 1995.
 State Highway Plans
 All Deeds on Record

Notes:

Area Surveyed is to be an
 "Add to" parcel only.

LINUS J. AND
 SANDRA CLUNE
 VOLUME 271 PAGE 71
 36.947 ACRES

AREA SURVEYED
 0.268 TOTAL ACRES
 0.030 R/W ACRES
 0.238 NET ACRES

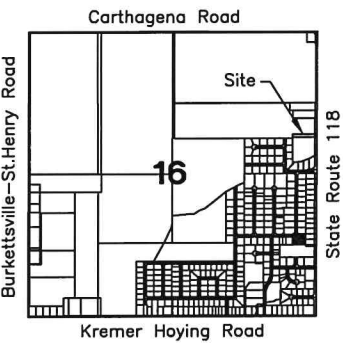
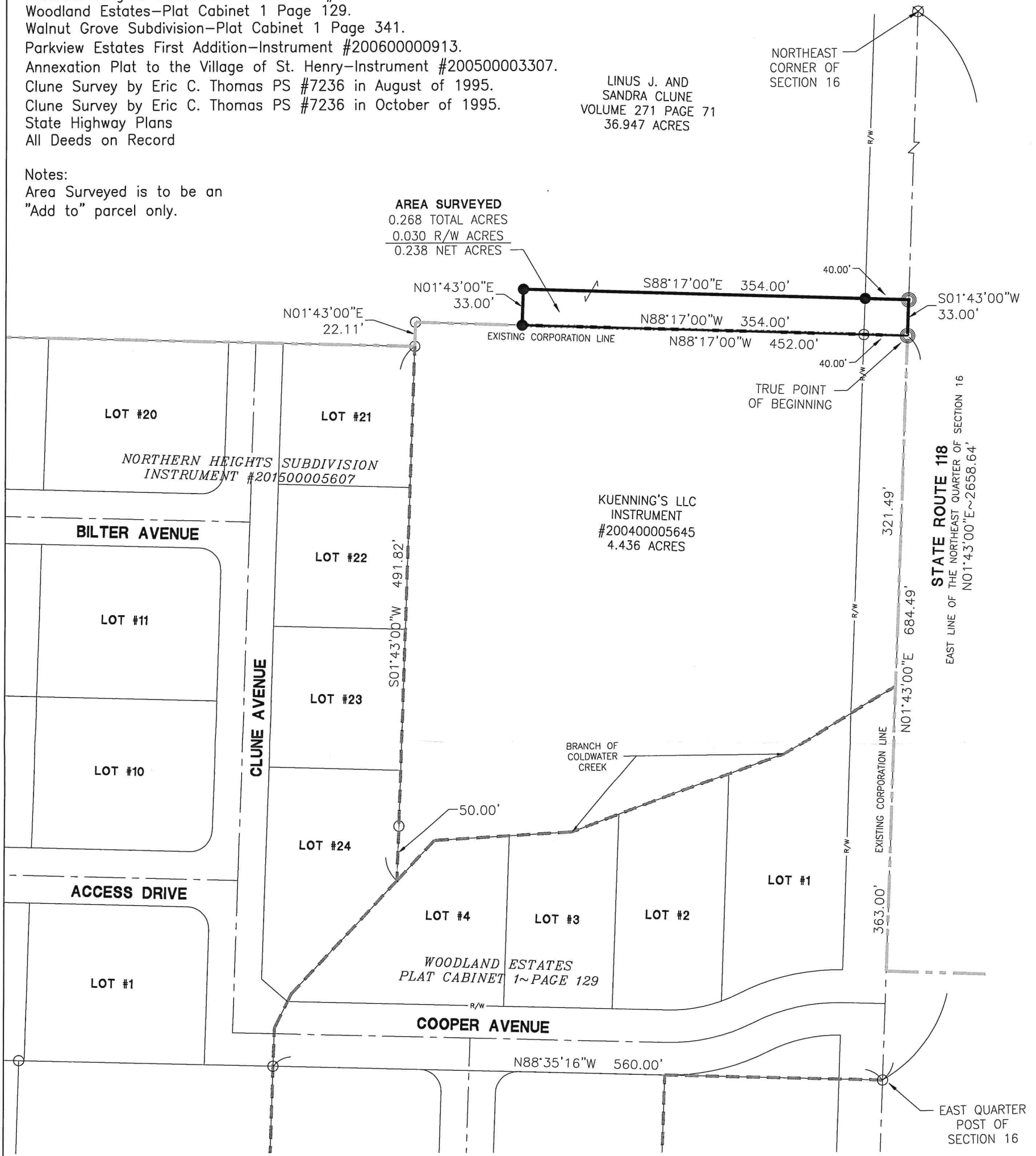

Surveyed By: 
 Craig W. Mescher Reg. Surveyor No. 8237

LEGEND

- ⊗ RR Spike Found
- Iron Pin Found
- Iron Pin Set
- ⊙ Mag Nail Set
- ⊗ Mag Nail Found
- Con Mon. Found
- △ Section Corner

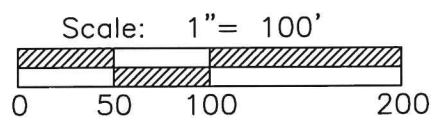

PROJECT # 220808.88

ACCESS
 Engineering Solutions
 1200 IRMSCHER BLVD., SUITE B, CELINA, OH 45822
 www.accessengllc.com | 419-586-1430

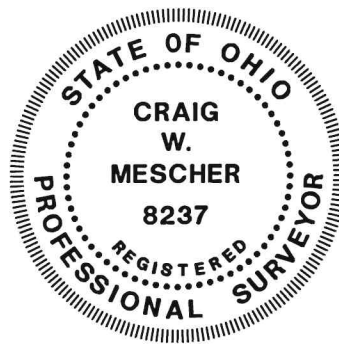

Basis of Bearings:
 Mercer County Local Coordinate Datum.

State of: Ohio County: Mercer
 Township: Granville
 Sec.: NE 1/4 16 Town: 7S Range: 2E
 Deed Ref.: D.V. 271 Page 71
 Date Surveyed: November 5, 2020

NORTHERN HEIGHTS SUBDIVISION LOTS 6 & 7 VACATED EASEMENT

BECKMAN & GAST COMPANY
INSTRUMENT 200400008618
38.78 ACRES

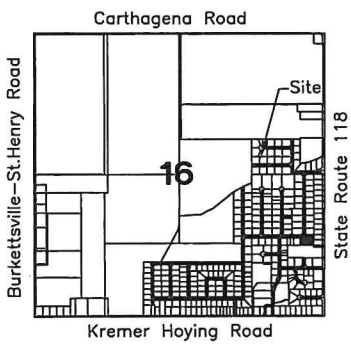
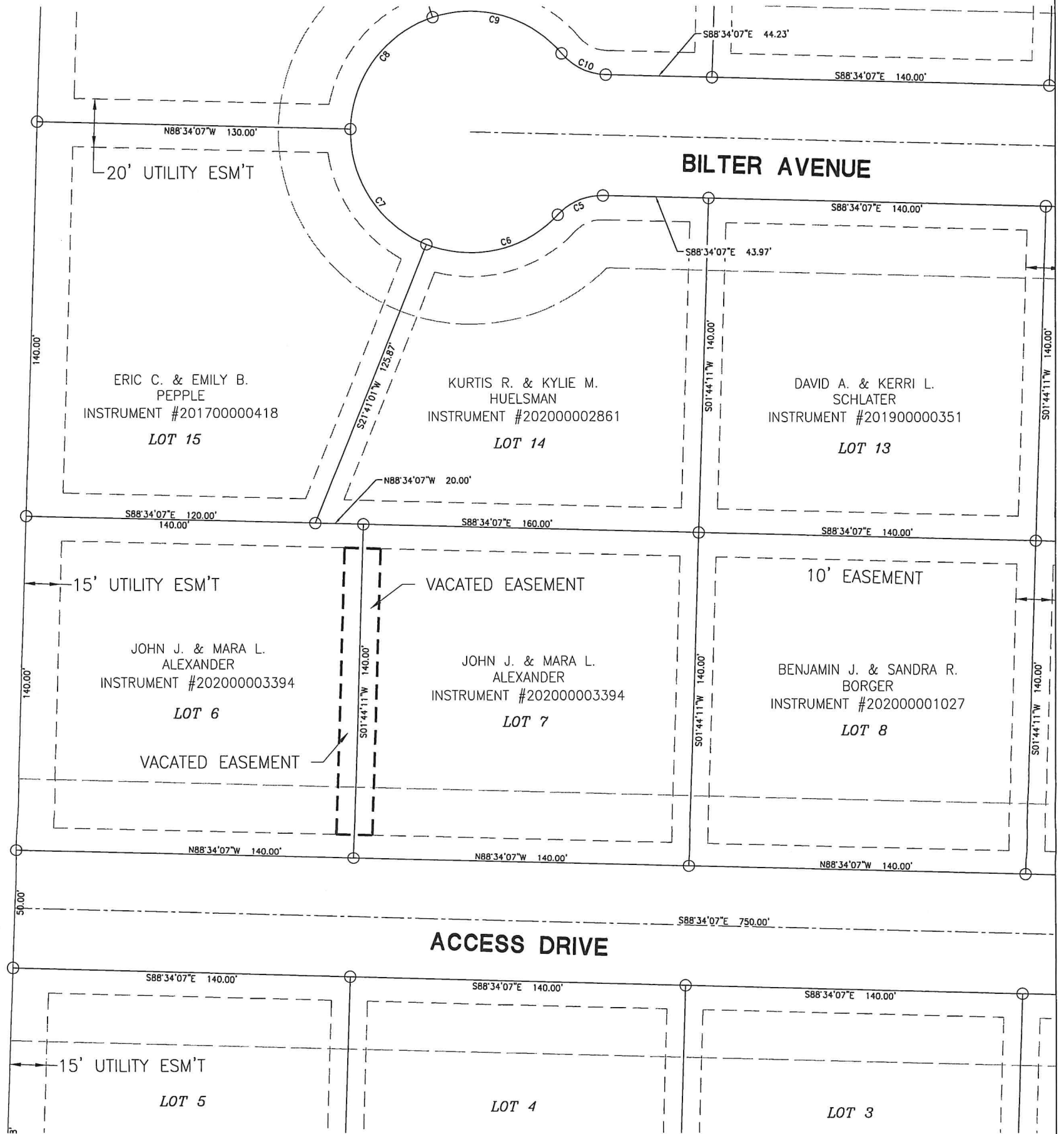

Stan Sutter
Village of St. Henry Administrator
Stan Sutter

Surveyed By: *Craig W. Mescher*
Craig W. Mescher Reg. Surveyor No. 8237

LEGEND

- ⊗ RR Spike Found
- Iron Pin Found
- Iron Pin Set
- ⊙ Mag Nail Set
- ⊗ Mag Nail Found
- Con Mon. Found
- △ Section Corner

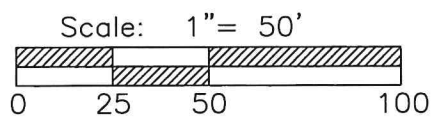

PROJECT # 221808.49

ACCESS
Engineering Solutions
1200 IRMSCHER BLVD., SUITE B, CELINA, OH 45822
www.accessengllc.com | 419-586-1430



References:

Bearings from Northern Heights Subdivision Plat by Craig W. Mescher P.S.# 8237 in November of 2015.

State of: Ohio County: Mercer
Township: Granville Village: St. Henry
Sec.: NE 1/4 16 Town: 7S Range: 2E
Plat Ref.: Instrument #201500005607
Date Surveyed: May 17, 2021