

# Hoelscher Survey

### Legend:

- Harrow Tooth @ NW Corner
- ⊗ P.K. nail Fd.
- P.K. nail set
- Iron Pin Fd.
- Iron Pin w/ Cap Set
- ▲ Stone @ W 1/4 Post

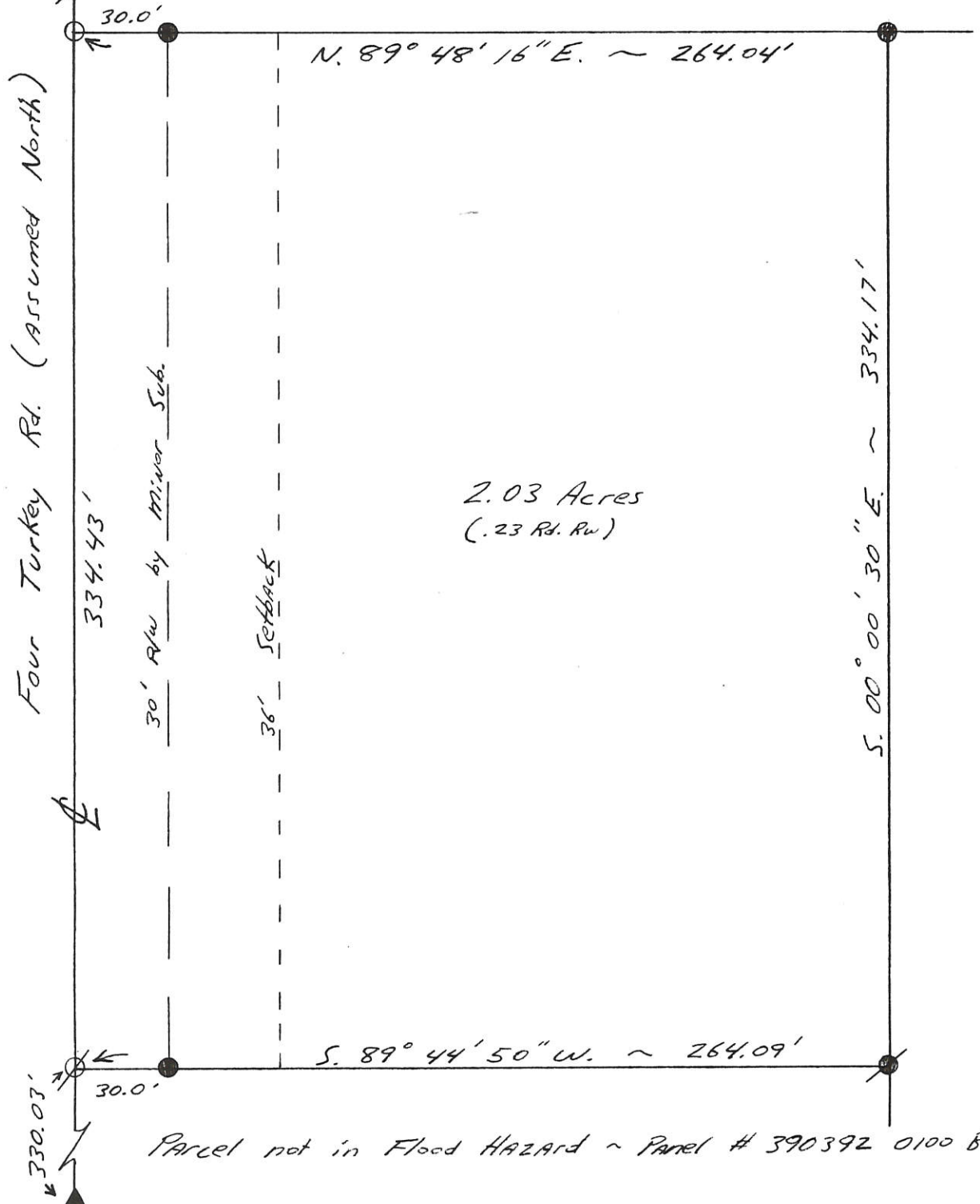
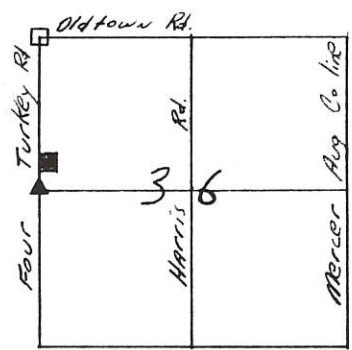
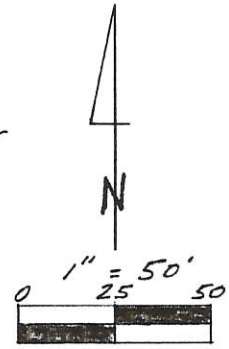

**Kent B. Marbaugh**  
 P.S. 7421  
 1210 Yorkshire Court  
 Celina, Ohio 45822  
 (419) 586-4293



Permanent Parcel Number

Part of: NW 1/4 Sec. 36 T 55 R 3E Jeff. Township  
 Grantor: \_\_\_\_\_ Area Retained: \_\_\_\_\_ Ac.  
 Grantee: \_\_\_\_\_ Area Transferred: \_\_\_\_\_ Ac.  
 Deed References: Db. 322 Pg. 464

Approvals: Rene W. Gentry  
 Agency: Board of Health  
 Date: 25 MAY 93

County Sanitary Engineer

John F. Ellmore  
 County Engineer  
5-25-93

5-15-93

*Kent Marbaugh*

**LEGEND**

- △ = HARROW TOOTH FOUND AT THE N. V. COR. OF THE N.E. 1/4 OF SEC. 36.
- ▲ = IRON BAR FOUND (REFER TO MERCER COUNTY GPS DATA)
- ⊗ = SPINDLE SET.
- = 5/8 INCH IRON BAR SET.
- BEARINGS BASED ON MERCER COUNTY GPS DATA.

\*\*\* REFER TO PRIOR SURVEY FOR HUT, 1999.

**LOCATION SKETCH**

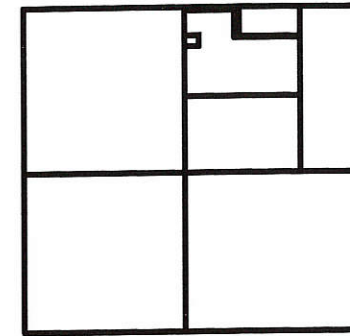

SECTION 36

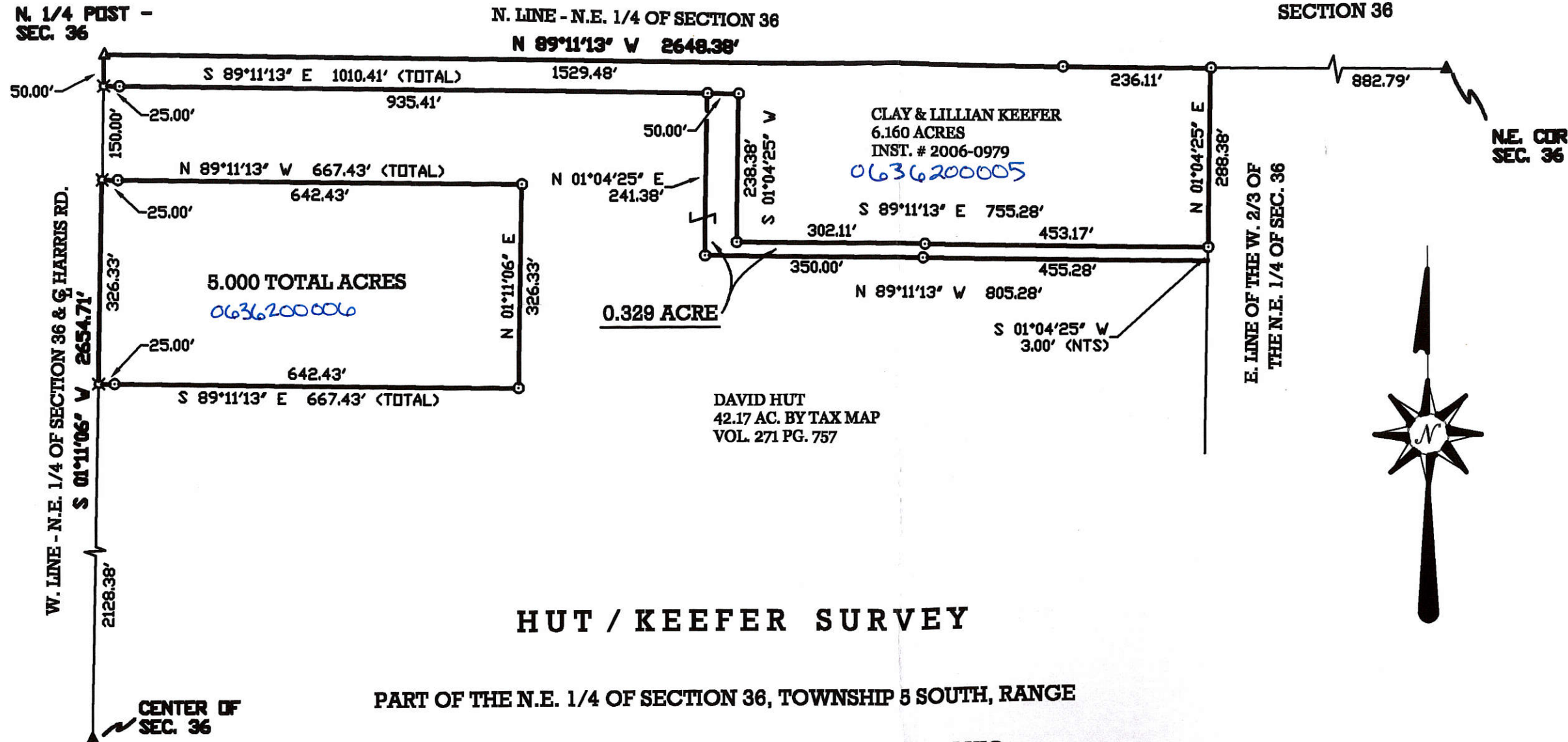

**HUT / KEEFER SURVEY**

PART OF THE N.E. 1/4 OF SECTION 36, TOWNSHIP 5 SOUTH, RANGE

3 EAST, JEFFERSON TOWNSHIP, MERCER COUNTY, OHIO.

SEPTEMBER 21, 2016

SCALE 1" = 200'



SURVEYED BY

*James W. Geeslin*  
 JAMES W. GEESLIN  
 P.S. 7764

PERMANENT  
 PARCEL No.

Part of: Sec. T. R. Township  
 Grantor: Area Retained: Acres  
 Grantee: Area Transferred: Acres

Deed References:

APPROVALS:  
 AGENCY: Board of Health  
 DATE:

County Engineer

County Sanitary Engineer

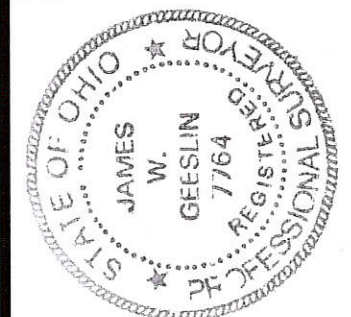

**GEESLIN**  
**LAND SURVEYING**

525 S. 2ND ST.  
 COLDWATER, OHIO 45828  
 PHONE (419) 678-7233

06-5(36)



**LEGEND**

- △ = HARROW TOOTH FOUND AT THE N. W. COR. OF THE N.E. 1/4 OF SEC. 36.
- ▲ = IRON BAR FOUND (REFER TO MERCER COUNTY GPS DATA)
- ⊙ = NAIL SET.
- ⊙ = 5/8 INCH IRON BAR SET.

- BEARINGS BASED ON MERCER COUNTY GPS DATA.

**LOCATION SKETCH**

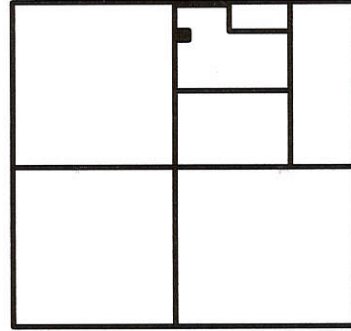

**SECTION 36**

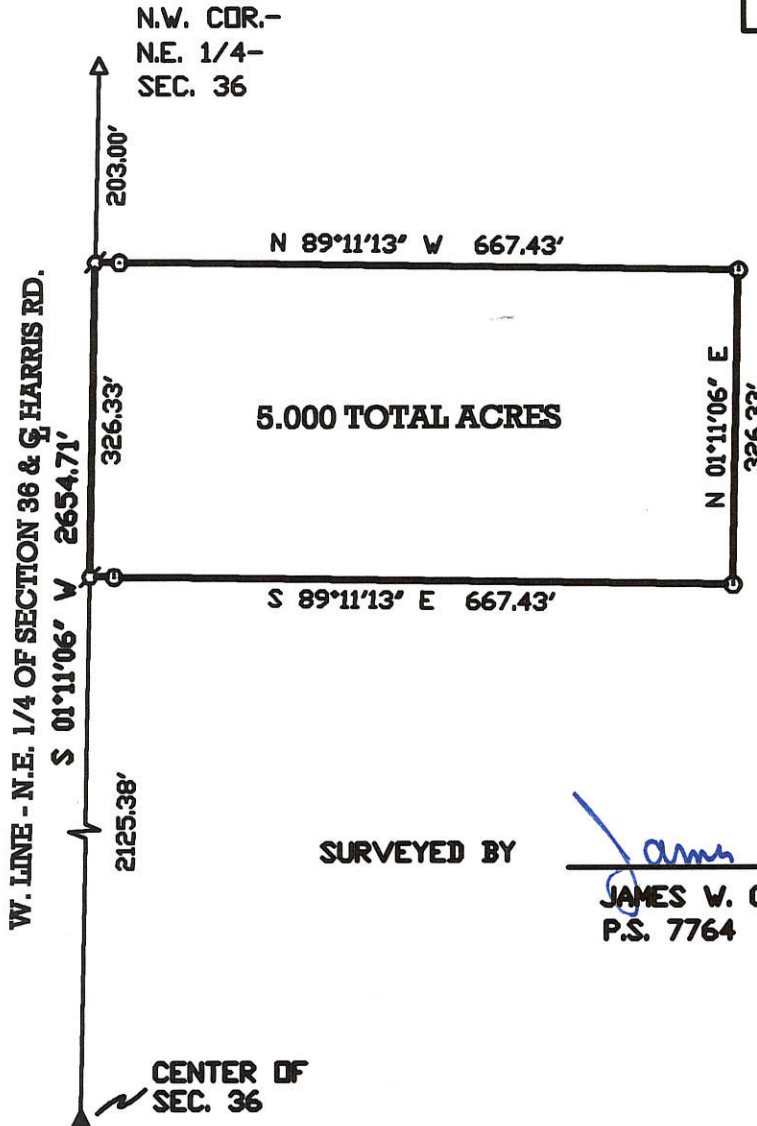

SURVEYED BY

*James W. Geeslin*  
**JAMES W. GEESLIN**  
 P.S. 7764

**WILLIAMS- HUT SURVEY**

PART OF THE N.E. 1/4 OF SECTION 36, TOWNSHIP 8 SOUTH, RANGE 3 EAST, JEFFERSON TOWNSHIP, MERCER COUNTY, OHIO.

APRIL 30, 2003

SCALE 1" = 200'



**GEESLIN LAND SURVEYING**

804 EAST MARKET STREET  
 P.O. BOX 422  
 CELINA, OHIO 45822

PHONE: (419) 586-6155  
 FAX: (419) 586-1826

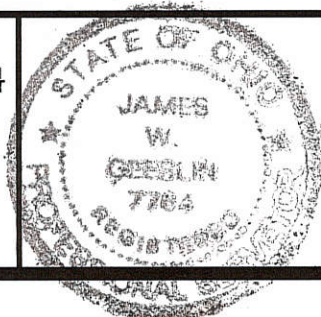

PERMANENT PARCEL No.	_____		
Part of	Sec. _____	T. _____	R. _____ Township _____
Grantor:	_____	Area Retained:	_____ Acres
Grantee:	_____	Area Retained:	_____ Acres
Deed References:	_____		
APPROVALS AGENCY:	_____	_____	_____
DATE:	Board of Health	County Sanitary Engineer	County Engineer

06-36-200-006

6-J ✓

06-36-200-005  
-006

06-3 ✓

**LEGEND**

- △ = HARROW TOOTH FOUND AT THE N. W. COR. OF THE N.E. 1/4 OF SEC. 36.
- ▲ = IRON BAR FOUND (REFER TO MERCER COUNTY GPS DATA)
- ⊗ = SPINDLE SET.
- = 5/8 INCH IRON BAR SET.
- BEARINGS BASED ON MERCER COUNTY GPS DATA.

**LOCATION SKETCH**

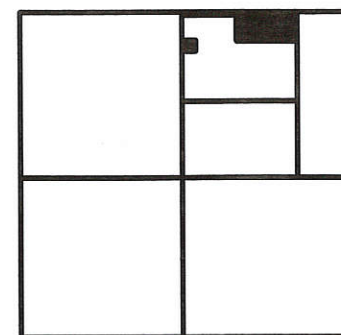

SECTION 36

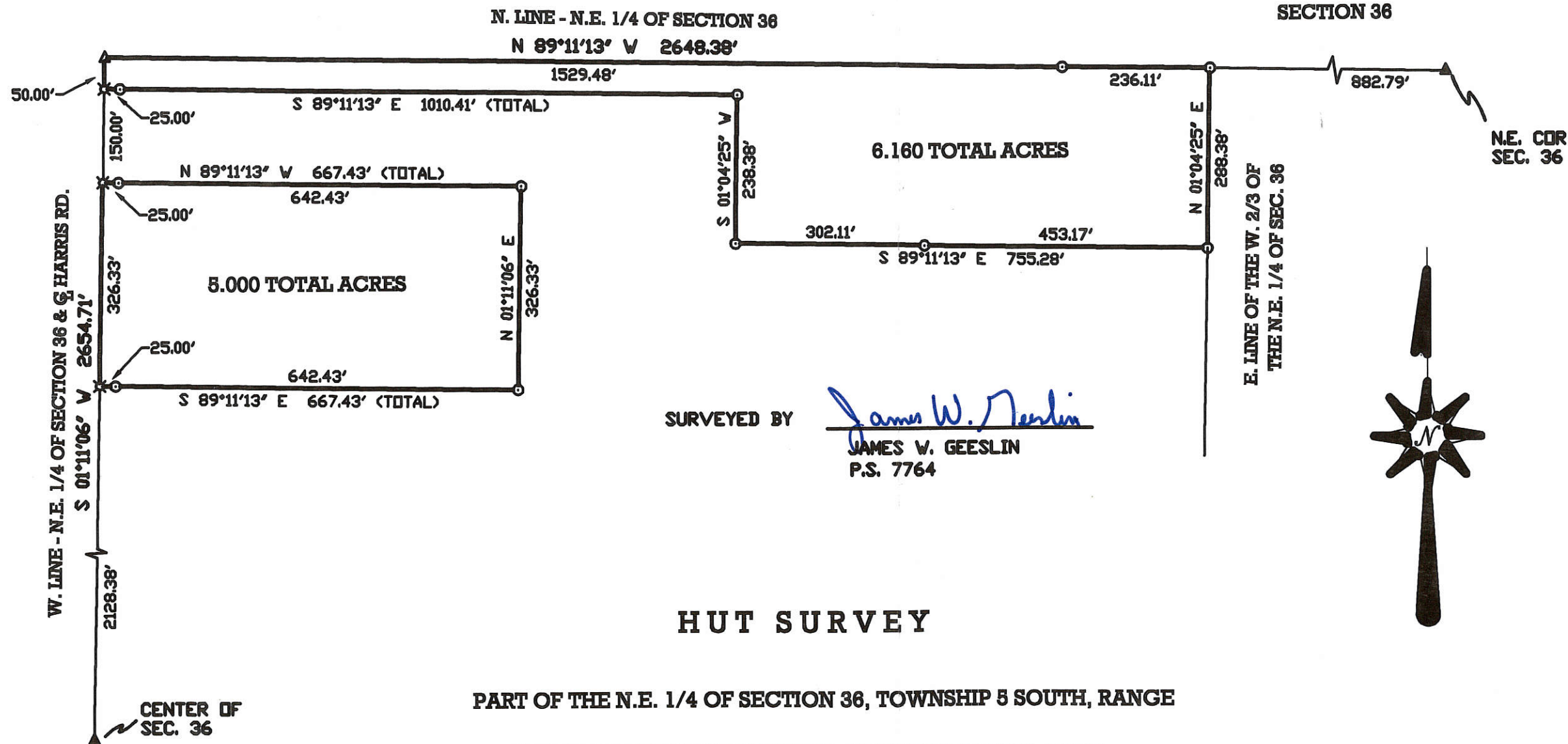

PERMANENT PARCEL No. \_\_\_\_\_

Part of: \_\_\_\_\_ Sec. \_\_\_\_\_ T \_\_\_\_\_ R \_\_\_\_\_ Township \_\_\_\_\_

Grantor: \_\_\_\_\_ Area Retained: \_\_\_\_\_ Acres

Grantee: \_\_\_\_\_ Area Transferred: \_\_\_\_\_ Acres

Deed References: \_\_\_\_\_

APPROVALS: \_\_\_\_\_

AGENT: \_\_\_\_\_

DATE: \_\_\_\_\_

Board of Health

County Sanitary Engineer

County Engineer



**GEESLIN**  
**LAND SURVEYING**  
 P.O. BOX 422  
 804 EAST MARKET STREET  
 CELINA, OHIO  
 PHONE (419) 586-6155  
 FAX (419) 586-1826





0636 300006

# SURVEY FOR MERCER ENERGY INVESTMENT LLC

BEING A PARCEL OF LAND LOCATED IN THE SOUTH HALF OF THE SOUTHWEST QUARTER OF SECTION 36, JEFFERSON TOWNSHIP, TOWN 5 SOUTH, RANGE 3 EAST, MERCER COUNTY, OHIO

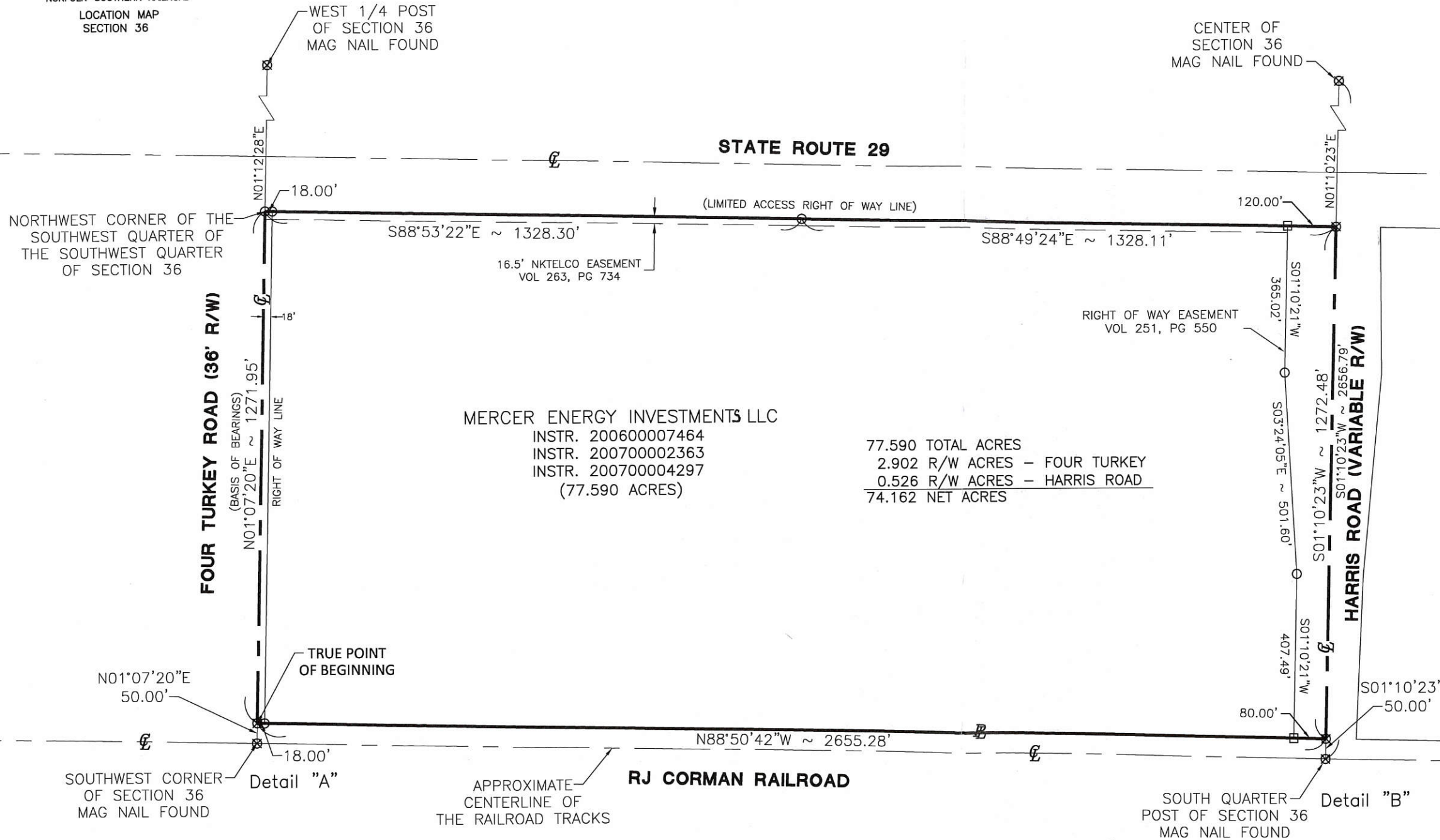
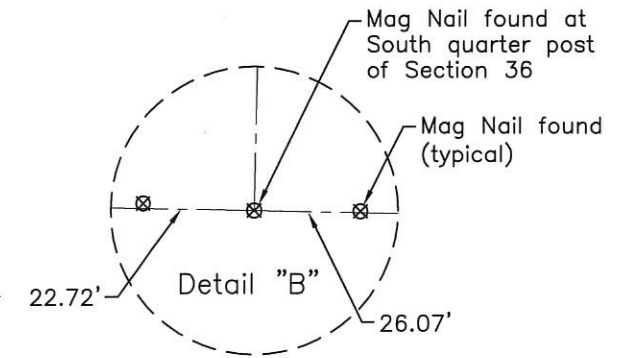
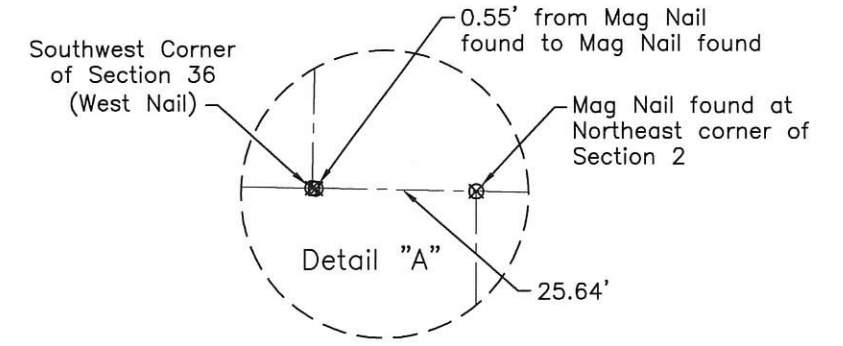
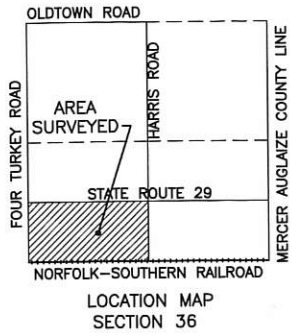

MERCER ENERGY INVESTMENTS LLC  
 INSTR. 200600007464  
 INSTR. 200700002363  
 INSTR. 200700004297  
 (77.590 ACRES)

77.590 TOTAL ACRES  
 2.902 R/W ACRES - FOUR TURKEY  
 0.526 R/W ACRES - HARRIS ROAD  
 74.162 NET ACRES

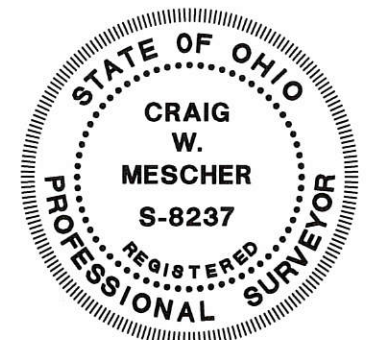

Surveyed By: *Craig W. Mescher*  
 Craig W. Mescher Reg. Surveyor No. 8237  
 Date: 10-04-12

**FANNING HOWEY**  
 ENGINEERING GROUP  
 1200 IRMSCHER BLVD. CELINA, OH 45822  
 www.fhai.com/civilengineering | 419-586-2292

### LEGEND

- Iron Pin Found
- ⊗ Mag Nail Found
- Concrete Monument Found



References:  
 Mercer County Local Coordinate Datum  
 State Right of Way Plans  
 Springer Trustees and MSK Partnership Survey by  
 Craig Mescher dated 8-8-06  
 All deeds of record

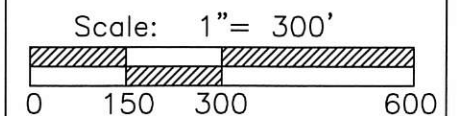

Part of S.W. 1/4 Sec. 36 T 5-S R 3-E JEFFERSON Twp., Mercer Co., OH  
 Grantor: \_\_\_\_\_ Deeds: \_\_\_\_\_ Area Retained \_\_\_\_\_ Ac.  
 Grantee: \_\_\_\_\_ Area \_\_\_\_\_ Ac.

06-J(36)



0636300006

# ALTA/ACSM LAND TITLE SURVEY FOR FERGUSON ENTERPRISES

BEING A PARCEL OF LAND LOCATED IN THE SOUTH HALF OF THE SOUTHWEST QUARTER OF SECTION 36, JEFFERSON TOWNSHIP, TOWN 5 SOUTH, RANGE 3 EAST, MERCER COUNTY, OHIO

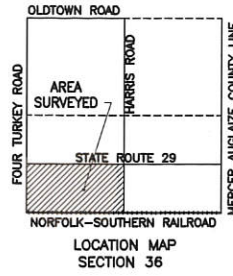
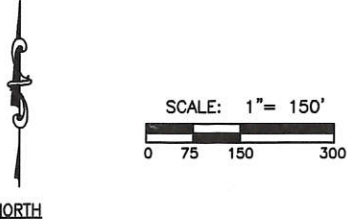

**BENCHMARK**  
BENCHMARKS WERE ESTABLISHED AND DETERMINED BY GPS OBSERVATIONS AND A HIGH-RESOLUTION GEOID MODEL (GEOID12A). THE CONCRETE MONUMENT FOUND IN THE NORTHEAST CORNER OF THE PROPERTY IS REFERENCED AS BENCHMARK #1. HAS A 1988 DATUM ELEVATION= 897.06

**FLOOD ZONE**  
PROPERTY IS LOCATED IN ZONE X. AREAS DETERMINED TO BE OUTSIDE THE 0.2% ANNUAL CHANCE FLOODPLAIN, AS PER COMMUNITY-PANEL NUMBER 39107CD190D. EFFECTIVE DATE MAY 16, 2012

**BASIS OF BEARINGS**  
BASIS OF BEARINGS ARE BASED UPON THE SPRINGER AND WSK SURVEY BY CRAIG W. MESCHER, REG. SURVEYOR #8237, DATED AUGUST 8, 2008.

**UTILITY STATEMENT**  
THE AREA SURVEYED HAS ACCESS TO PUBLIC SANITARY SEWER, ELECTRIC, AND TELEPHONE.

**PROPERTY ADDRESS**  
ADDRESS OF THE SURVEYED PROPERTY:  
NO ADDRESS REFERENCED

**ZONING**  
ZONED I, INDUSTRIAL DISTRICT  
MINIMUM FRONT SETBACK--50'  
MINIMUM SIDE SETBACK--30'  
MINIMUM REAR SETBACK--40'  
MAXIMUM BUILDING HEIGHT--45'  
MAXIMUM PERCENT LOT COVERAGE--50%

## LOCAL CONTACTS

**ELECTRIC**  
DAYTON POWER AND LIGHT  
2385 CAMPBELL ROAD  
SIDNEY, OHIO 45365  
(937) 331-3688

**SEWER**  
MERCER COUNTY SANITARY DEPARTMENT  
220 WEST LIVINGSTON STREET  
ROOM A230  
CELINA, OHIO 45822  
(419) 584-1982

**TELEPHONE**  
FRONTIER COMMUNICATIONS  
1951 GRAND LAKE ROAD  
CELINA, OHIO 45822  
(419)-588-1807

**GAS**  
DOMINION EAST OHIO  
150 S. JACKSON STREET  
LIMA, OHIO 45802  
(419)-228-4700

**WATER**  
CELINA MUNICIPAL UTILITIES  
WATER DEPARTMENT  
428 WEST MARKET STREET  
P.O. BOX 297  
CELINA, OHIO 45822  
(419) 586-2311

## SYMBOL LEGEND

- SAN — SANITARY LINE
- W — WATER LINE
- ELEC — BURIED ELECTRIC
- T — BURIED TELEPHONE
- STM — STORM SEWER LINE
- ☐ MAILBOX
- ☒ TELEPHONE BOX
- ☒ ELECTRIC BOX
- ☒ CABLE BOX
- GUY WIRE
- SIGN —
- ☐ CATCH BASIN
- ⚡ POWER POLE
- IRON PIN FOUND
- 5/8" IRON PIN W/ CAP SET
- ☒ MAG NAIL FOUND
- RAILROAD SPIKE FOUND

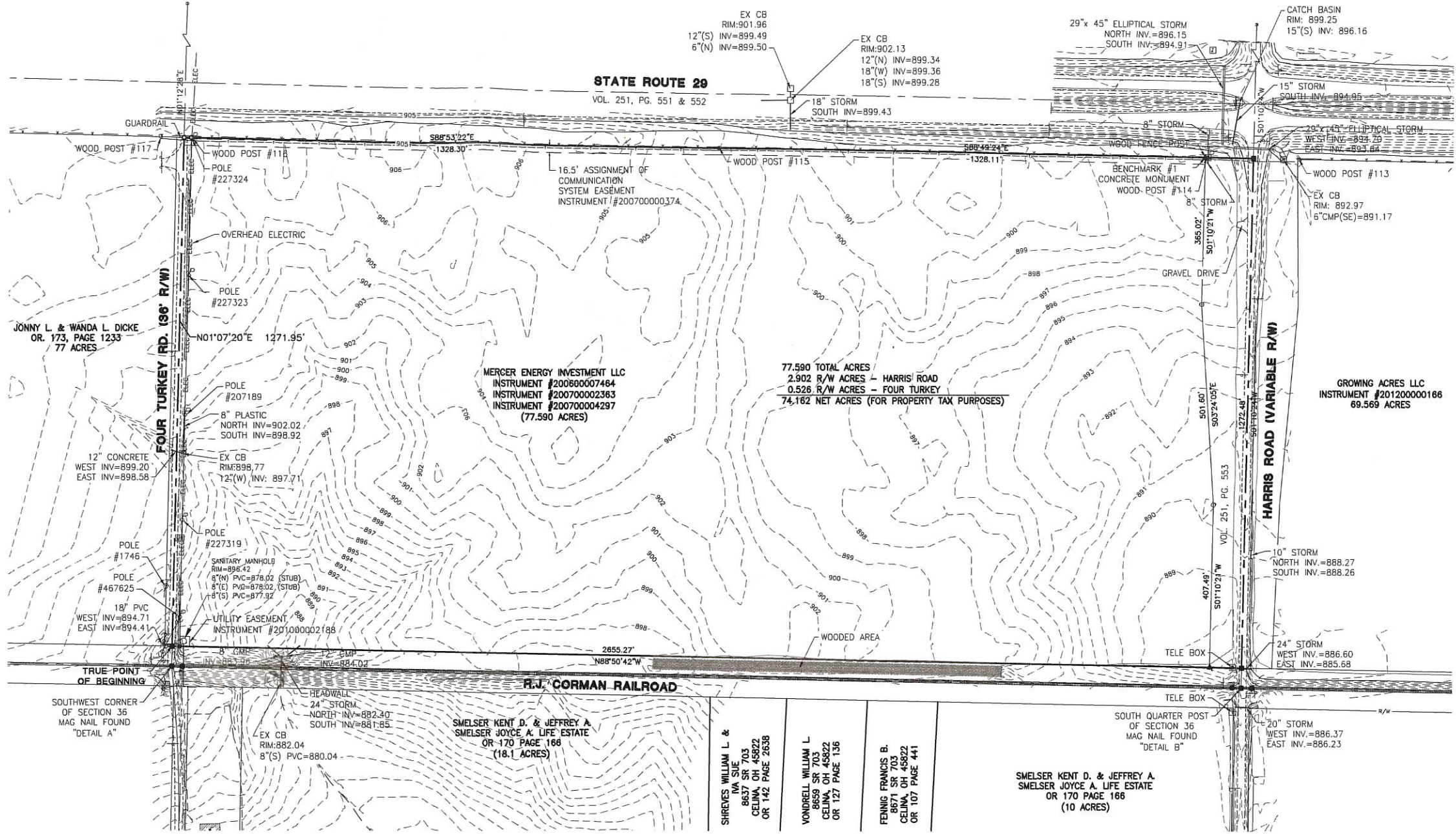
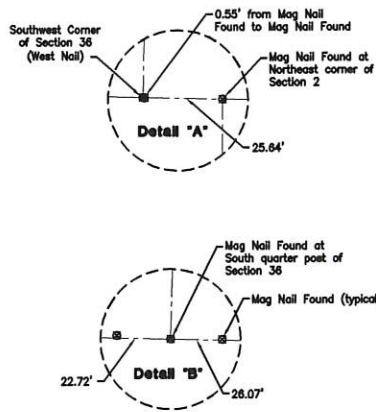

## DESCRIPTION - 77.590 Acres

Being a tract in the South Half of the Southwest Quarter of Section 36, Jefferson Township, Town 5 South, Range 3 East, Mercer County, Ohio, being more particularly described as follows:

Commencing at a Mag Nail Found marking the Southwest Corner of Section 36;

Thence North 01°07'20" East (Basis of Bearings) along the west line of Section 36 and the approximate centerline of Four Turkey Road, a distance of fifty and zero hundredths feet (50.00') to a Mag Nail Found, for the TRUE POINT OF BEGINNING;

Thence continuing North 01°07'20" East along the west line of Section 36 and the approximate centerline of Four Turkey Road, a distance of one thousand two hundred seventy-one and ninety-five hundredths feet (1271.95') to an Iron Pin Found;

Thence South 88°53'22" East along the south Limited Access Right of Way line of State Route 29, a distance of one thousand three hundred twenty-eight and thirty hundredths feet (1328.30') to an Iron Pin Found, passing an Iron Pin Found at 18.00';

Thence South 88°49'24" East along the south Limited Access Right of Way line of State Route 29, a distance of one thousand three hundred twenty-eight and eleven hundredths feet (1328.11') to a Mag Nail Found, passing a Concrete Monument Found at 1208.11';

Thence South 01°10'23" West along the east line of the Southwest Quarter of Section 36 and the approximate centerline of Harris Road, a distance of one thousand two hundred seventy-two and forty-eight hundredths feet (1272.48') to a Mag Nail Found;

Thence North 88°50'42" West along the north line of Norfolk-Southern Railroad, a distance of two thousand six hundred fifty-five and twenty-eight hundredths feet (2655.28') to the TRUE POINT OF BEGINNING, passing a Concrete Monument Found at 80.00' and an Iron Pin Found at 2637.28', containing 77.590 Acres of land more or less.

Said tract being subject to all highways and any other easements or restrictions of record.

Previous Deed Reference: Instrument #200600007464, #200700002363, #200700004297

Description based on a survey by Craig W. Mescher Registered Surveyor No. 8237 in October 2012 and is on file with the Mercer County Engineers Office.



## SURVEYOR'S CERTIFICATE

TO FERGUSON ENTERPRISES:

THIS IS TO CERTIFY THAT THIS MAP OR PLAT AND THE SURVEY ON WHICH IT IS BASED WERE MADE IN ACCORDANCE WITH THE 2011 MINIMUM STANDARD DETAIL REQUIREMENTS FOR ALTA/ACSM LAND TITLE SURVEYS, REFERENCED BY TABLE A AND INCLUDES ITEMS 1, 2, 3, 4, 5, 8(0), 7(A), 7(B), 8, 9, 11(B), 13, 21. THE FIELD WORK WAS COMPLETED ON FEBRUARY 22, 2013.

CRAIG W. MESCHER, P.S. #8237 DATE

TELEPHONE: (419) 586-2292 x11037  
EMAIL: cmescher@fhai.com  
PROJECT: D:\212808.43\Ferguson ALTA.dwg

Mar 21, 2013 9:31:56 AM D:\212808.43\Ferguson ALTA.dwg

**FANNING HOWEY**  
ENGINEERING GROUP  
1200 IRMSCHER BLVD. CELINA, OH 45822  
www.fhai.com/civilengineering | 419-586-2292

06-J(36)



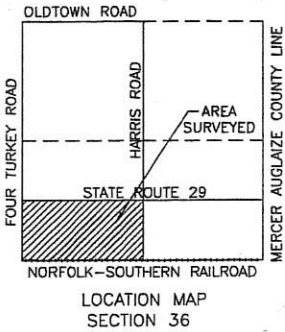

# SURVEY FOR CLARK R. AND JUDY A. SPRINGER TRUSTEES AND MSK PARTNERSHIP

BEING A PARCEL OF LAND LOCATED IN THE SOUTH HALF OF THE SOUTHWEST QUARTER OF SECTION 36, JEFFERSON TOWNSHIP, TOWN 5 SOUTH, RANGE 3 EAST, MERCER COUNTY, OHIO

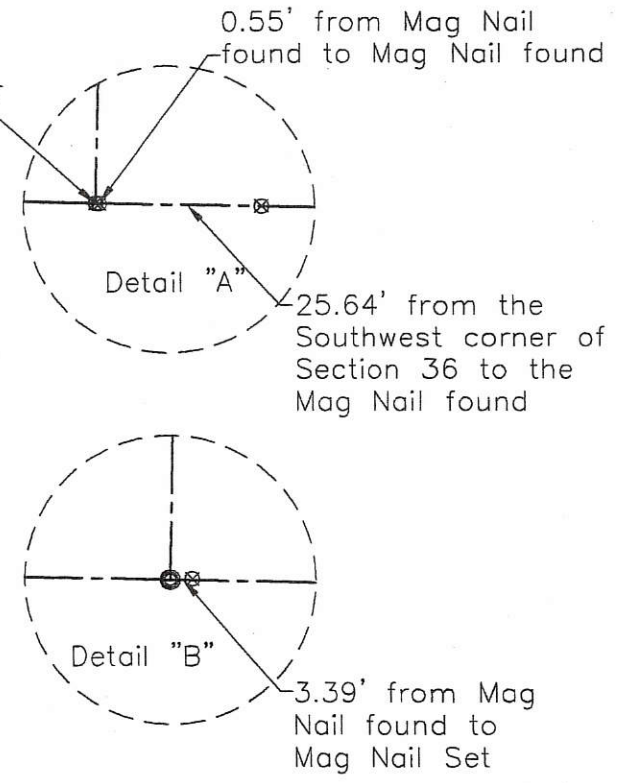
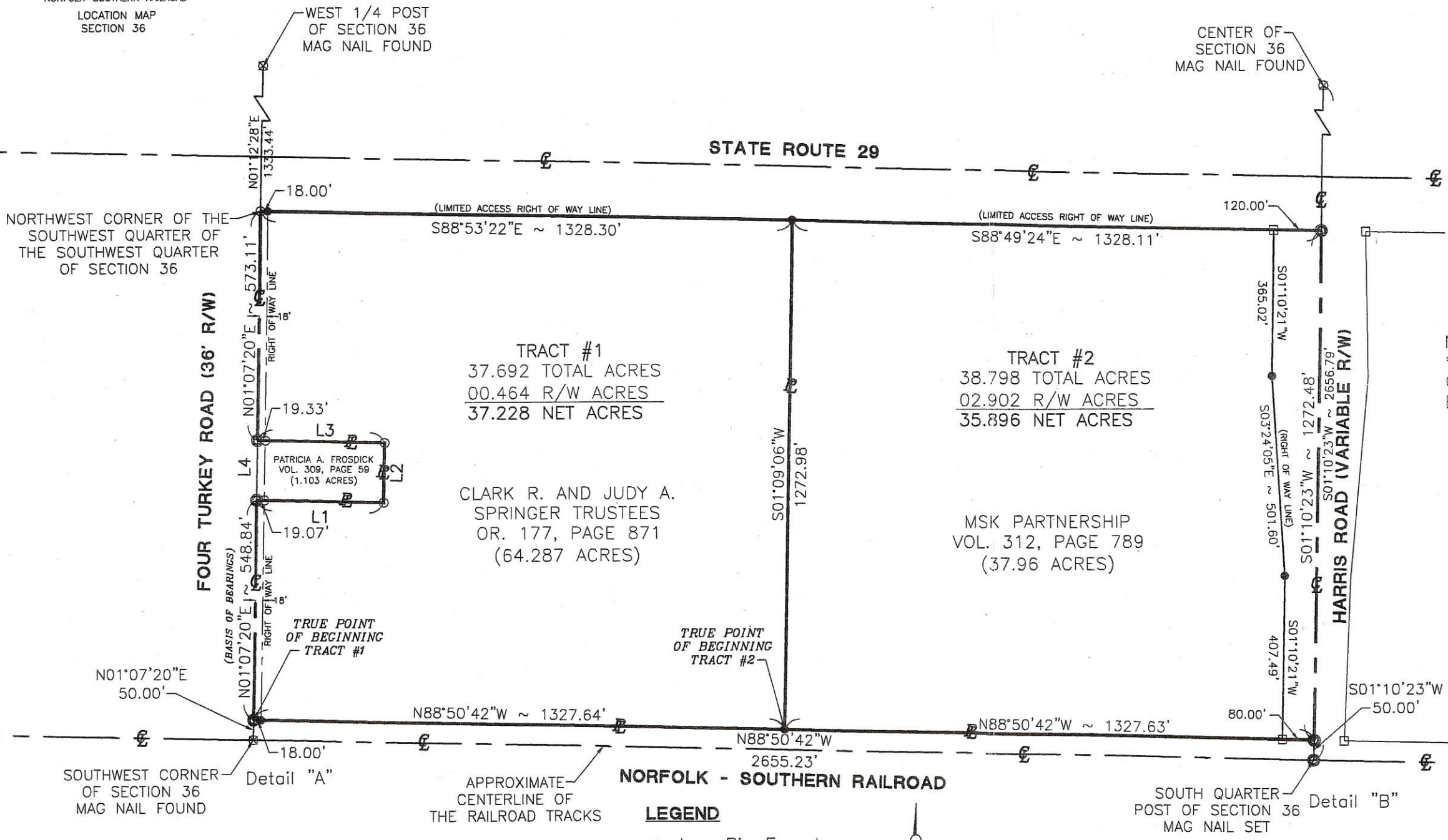

NOTES:  
 \*AREA SURVEYED IS OUTSIDE THE FLOOD PLAIN COMMUNITY PANEL NUMBER-390392 0100 B  
 EFFECTIVE DATE: SEPTEMBER 6, 1989

*Bruce Blair*  
 Zoning Inspector

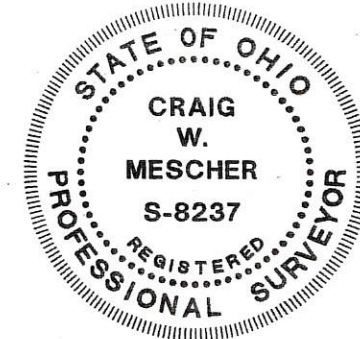

Surveyed By: *[Signature]*  
 Craig W. Mescher Reg. Surveyor No. 8237  
 Date: 08-08-06

**FANNING HOWEY**  
 CIVIL ENGINEERING DIVISION  
 1200 IRMSCHER BOULEVARD CELINA, OHIO 45822  
 www.fhai.com/civilengineering 419.586.2292

- LEGEND**
- Iron Pin Found
  - Iron Pin Set
  - ⊙ Mag Nail Set
  - ⊗ Mag Nail Found
  - Concrete Monument Fd

LINE	BEARING	DISTANCE
L1	S88°49'09"E	319.49'
L2	N01°10'51"E	150.00'
L3	N88°49'09"W	319.64'
L4	N01°07'20"E	150.00'

References:  
 Mercer County Local Coordinate Datum  
 State Right of Way Plans  
 All deeds of record

Scale: 1" = 300'

Part of S.W. 1/4 Sec. 36 T. 5-S R. 3-E JEFFERSON Twp., Mercer Co., OH  
 Grantor: \_\_\_\_\_ Deeds: \_\_\_\_\_ Area Retained \_\_\_\_\_ Ac.  
 Grantee: \_\_\_\_\_ Area \_\_\_\_\_ Ac.

06-36-300-006



# SURVEY FOR CLARK R. AND JUDY A. SPRINGER TRUSTEES AND MSK PARTNERSHIP

BEING A PARCEL OF LAND LOCATED IN THE SOUTH HALF OF THE SOUTHWEST QUARTER OF SECTION 36, JEFFERSON TOWNSHIP, TOWN 5 SOUTH, RANGE 3 EAST, MERCER COUNTY, OHIO

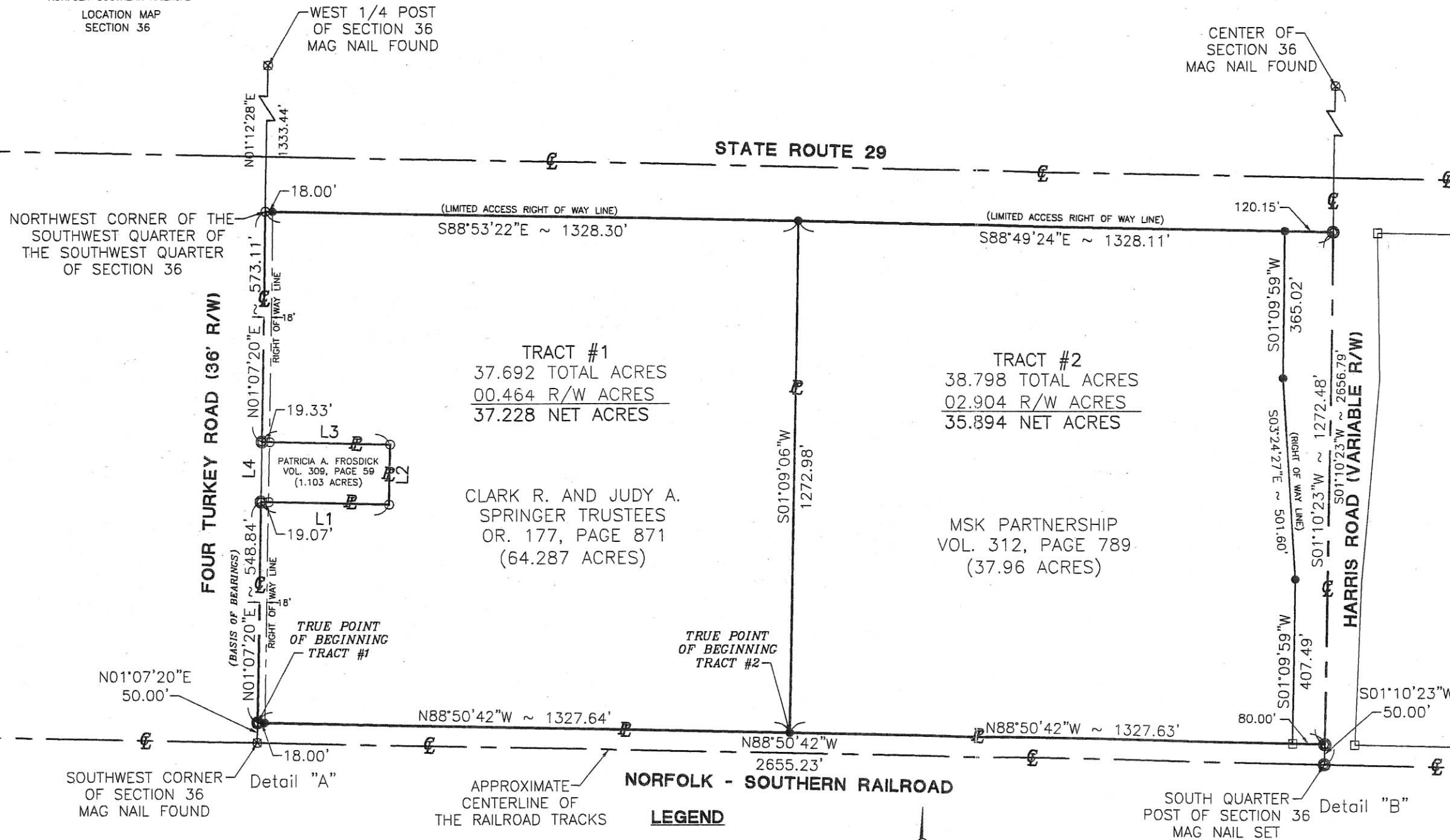
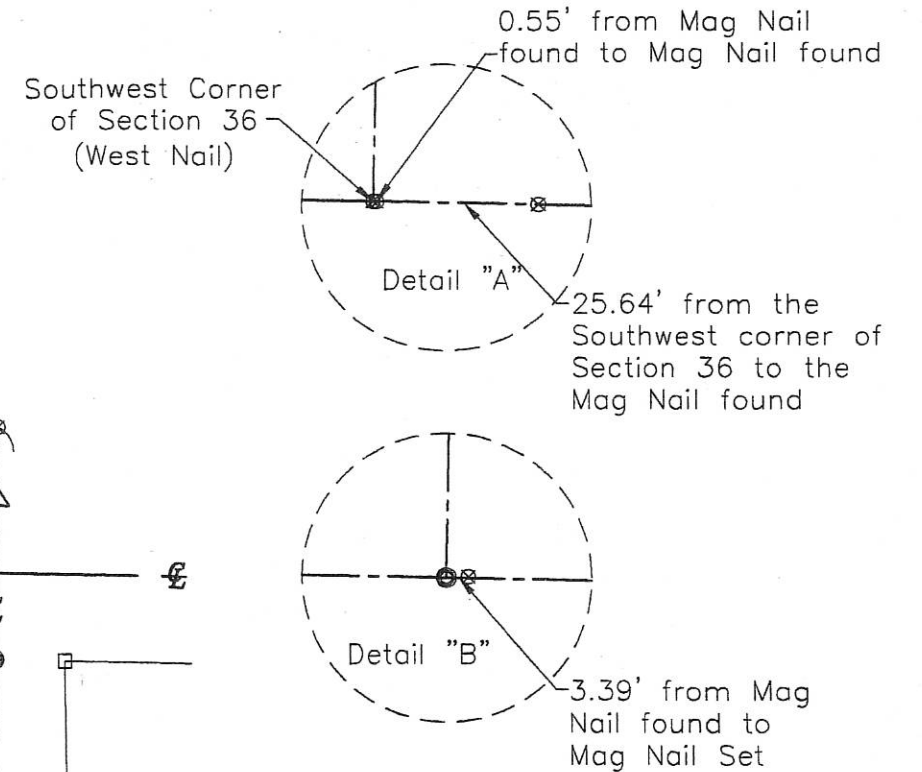
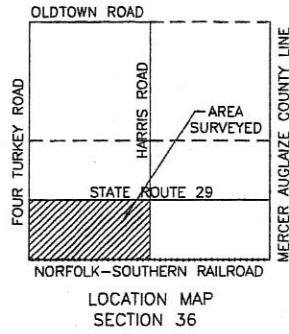

NOTES:  
 \*AREA SURVEYED IS OUTSIDE THE FLOOD PLAIN COMMUNITY PANEL NUMBER-390392 0100 B  
 EFFECTIVE DATE: SEPTEMBER 6, 1989

Zoning Inspector \_\_\_\_\_

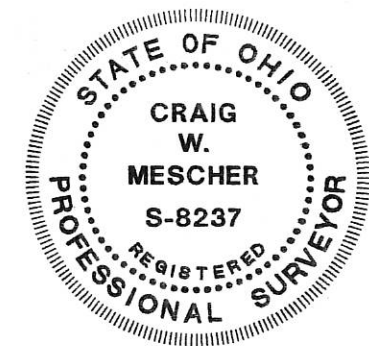

Surveyed By: \_\_\_\_\_  
 Craig W. Mescher Reg. Surveyor No. 8237  
 Date: 08-08-06

**FANNING HOWEY**  
 CIVIL ENGINEERING DIVISION  
 1200 IRMSCHER BOULEVARD CELINA, OHIO 45822  
 www.fhai.com/civilengineering | 419.586.2292

**LEGEND**

- Iron Pin Found
- Iron Pin Set
- ⊙ Mag Nail Set
- ⊗ Mag Nail Found
- Concrete Monument Fd

LINE TABLE		
LINE	BEARING	DISTANCE
L1	S88°49'09"E	319.49'
L2	N01°10'51"E	150.00'
L3	N88°49'09"W	319.64'
L4	N01°07'20"E	150.00'

References:  
 Mercer County Local Coordinate Datum  
 State Right of Way Plans  
 All deeds of record

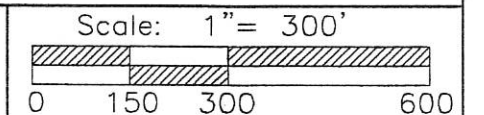

Part of S.W. 1/4 Sec. 36 T. 5-S R. 3-E JEFFERSON Twp., Mercer Co., OH  
 Grantor: \_\_\_\_\_ Deeds: \_\_\_\_\_ Area Retained \_\_\_\_\_ Ac.  
 Grantee: \_\_\_\_\_ Area \_\_\_\_\_ Ac.

06-5  
06-36-300-006



**LOCATION SKETCH**

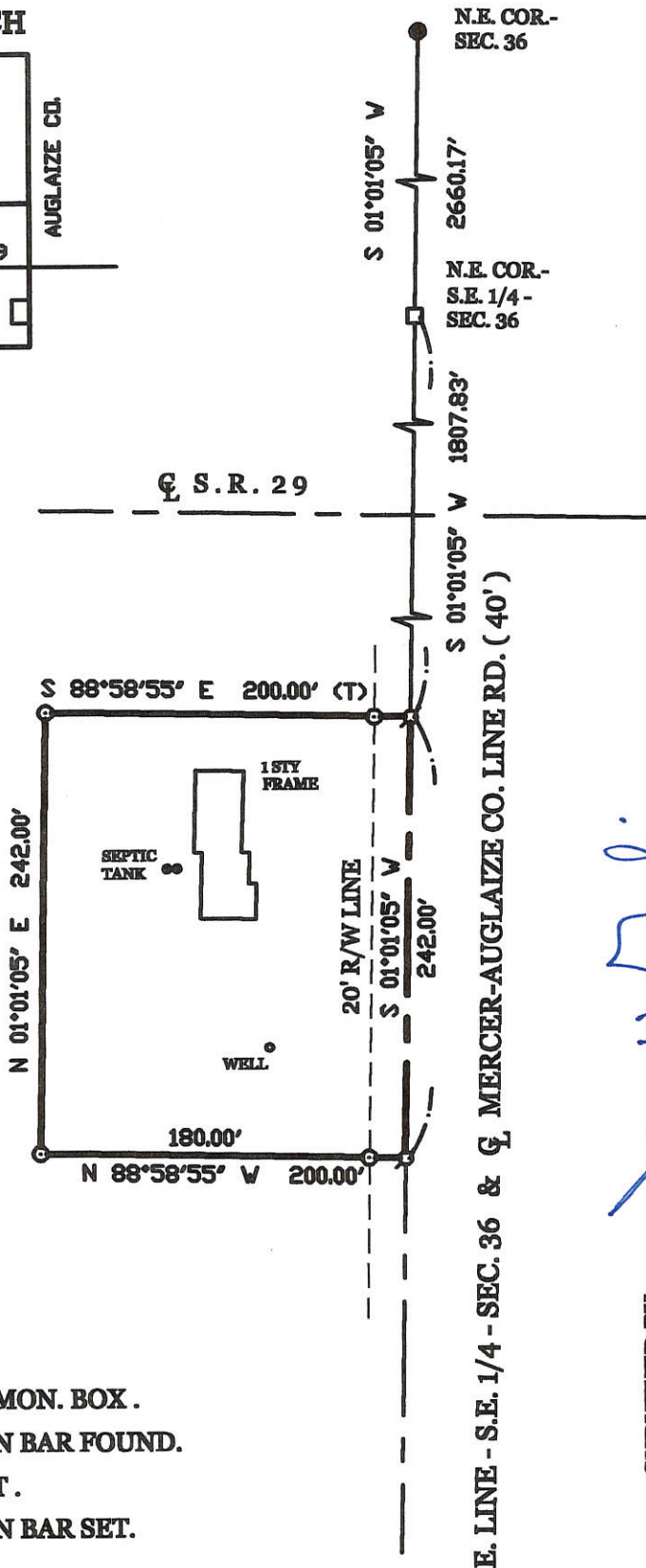
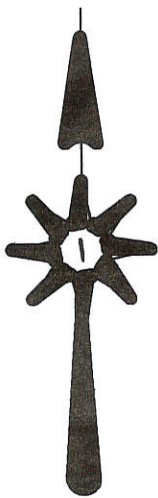
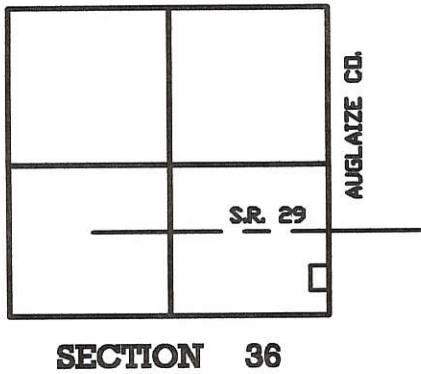

**LEGEND**

- = IRON BAR IN MON. BOX .
- = 5/8 INCH IRON BAR FOUND.
- ⊗ = MAG NAIL SET .
- ⊙ = 5/8 INCH IRON BAR SET.

*James W. Geeslin*  
 JAMES W. GEESLIN  
 P.S. No. 7764

SURVEYED BY

**DICKE SURVEY**

PART OF THE S. 1/2 OF THE S.E. 1/4 OF SECTION 36 , TOWN 5 SOUTH , RANGE 3 1/2 EAST , ( JEFFERSON TOWNSHIP ) , MERCER COUNTY , OHIO .

FEBRUARY 22, 2005

SCALE 1" = 100'



**GEESLIN LAND SURVEYING**

P.O. BOX 422  
 CELINA, OHIO 45822  
 PHONE: (419) 586-6155  
 FAX: (419) 678-9332



PERMANENT PARCEL No.	_____		
Part of	Sec. _____	T. _____	R. _____ Township
Grantor:	_____	Area Retained:	_____ Acres
Grantee:	_____	Area Retained:	_____ Acres
Used References:	_____		
APPROVALS AGENCY:	_____	_____	_____
Board of Health	Date	Township Zoning Officer	Date
County Engineer	Date	_____	_____

06-26-400-003

# LEGEND

- COR. STONE & CENTER & SEC. 36.
- COR. STONE & N. 1/4 POST & SEC. 36.
- BOAT PILE & W. 1/4 POST & SEC. 36.
- COR. STONE & N. 1/4 POST & N. 1/4 & SEC. 36.
- COR. STONE & W. 1/4 POST & SEC. 36.
- MINE BRICK SET.
- 3/4" x 3/4" IRON BRICK SET.
- 5" IRON BRICK SET.

# LOCATION SKETCH

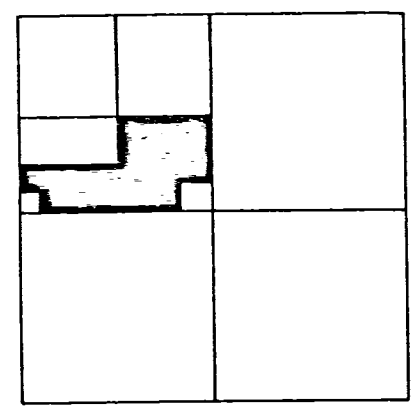

SECTION 36

**NOTE** REF. IS MADE TO & BEAR. BASIS TAKEN FROM A SURVEY BY ME (MIESSE) DATED 11-16-88.

N. LINE ~ N.W. 1/4 & E. OLDTOWN RD.  
 S. 89° 50' 55" E. ~ 2647.97

SURVEYED BY *Gordon L. Geeslin*  
 GORDON L. GEESLIN  
 REG. SURVEYOR 5372

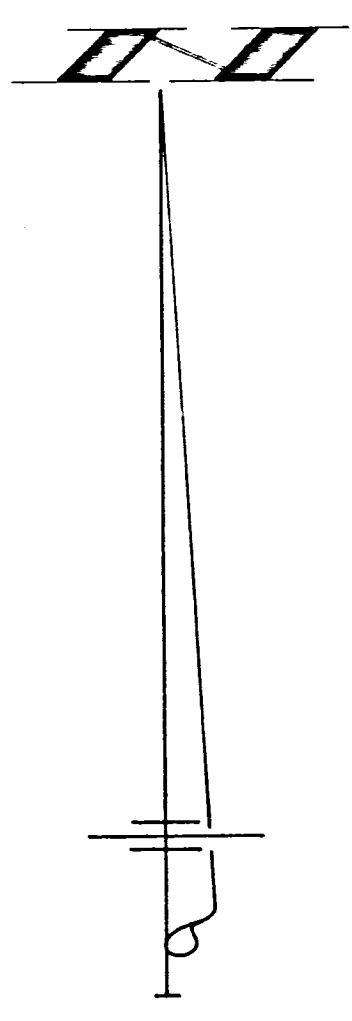
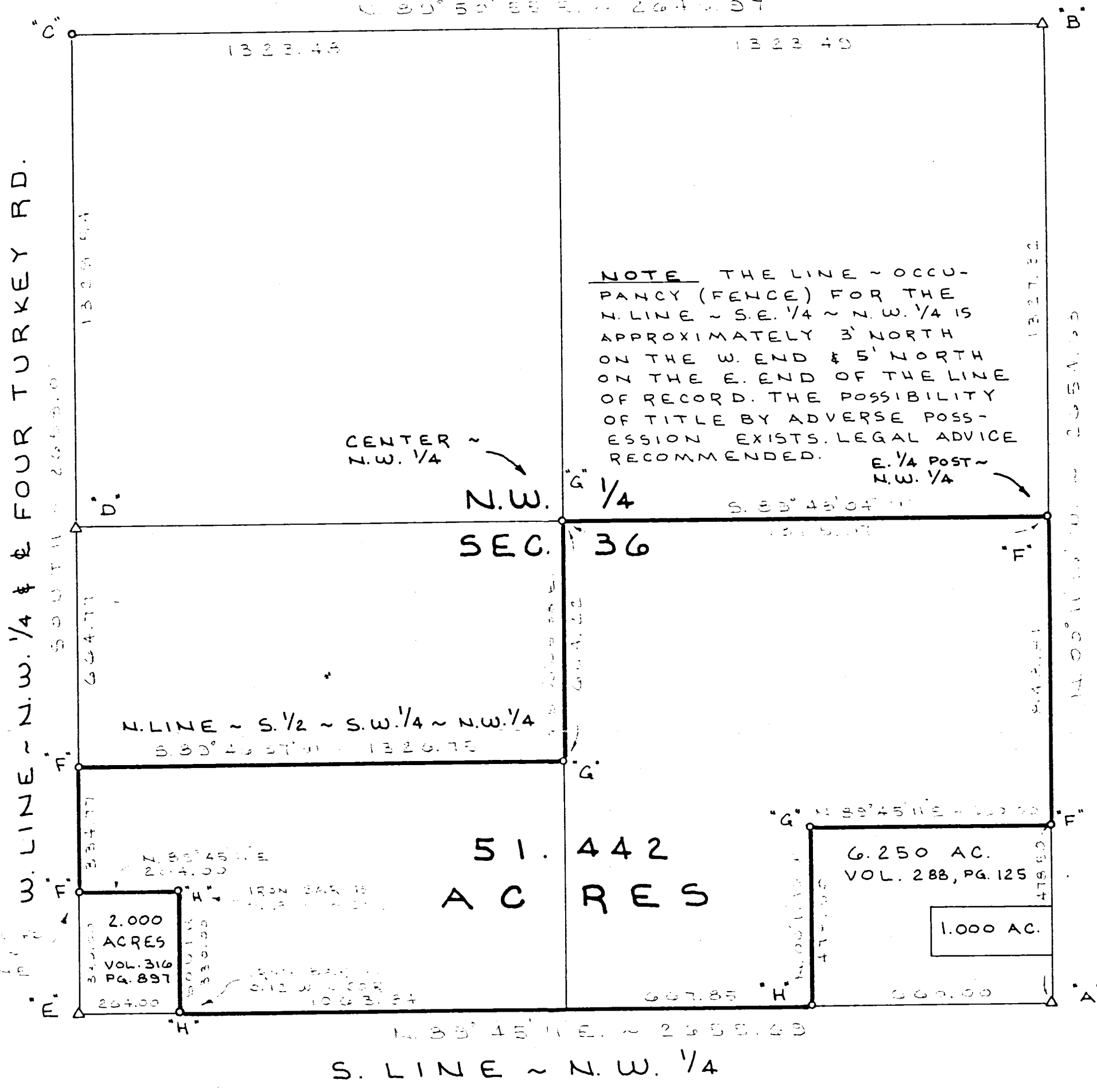

# VANTILBURG SURVEY

PART OF THE S. 1/2 OF THE N.W. 1/4 OF SECTION 36, TOWN 5 SOUTH, RANGE 3 EAST, (JEFFERSON TOWNSHIP), MERCER COUNTY, OHIO.

FEBRUARY 17, 1992

SCALE 1" = 300'

**GORDON L. GEESLIN**  
 LAND SURVEYOR  
 810 EAST MARKET STREET  
 CELINA, OHIO  
 PHONE (419) 586-6155



PERMANENT PARCEL No. \_\_\_\_\_

Part of: \_\_\_\_\_ Sec. \_\_\_\_\_ T. \_\_\_\_\_ R. \_\_\_\_\_ Township

Grantor: \_\_\_\_\_ Area Retained: \_\_\_\_\_ Acres

Grantee: \_\_\_\_\_ Area Transferred: \_\_\_\_\_ Acres

Deed References: \_\_\_\_\_

APPROVALS	Board of Health	County Sanitary Engineer	County Engineer
AGENCY			
DATE			



06-36-300-005 06-1  
300-005



LEONA SPRINGER 73.50 ACRES  
W. LINE OF N.E. 1/4 OF S.W. 1/4 OF SEC. 36  
N. 1° 26' 01" E. ~ 1067.60'

"A" 1328.03' "D"

S. 88° 39' 19" E. ~ 668.08'  
N. LINE OF N.E. 1/4 OF S.W. 1/4 OF SEC. 36

22.700 ACRES

"D" 330.00' "D"  
RALPH VANTILBURG  
5 ACRES  
S. 88° 39' 19" E. ~ 660.00'

"C" 554.64' "D"  
N. 88° 35' 05" W. ~ 664.67'

MILLER BRO. CONST. CO.  
4.881 ACRES

S. 1° 21' 55" W.  
320.00'

419.25' "D"  
E. LINE OF N.E. 1/4 OF S.W. 1/4 OF SEC. 36 # 2 OF HARRIS RD.  
S. 1° 24' 15" W.

"D" N. RIGHT-OF-WAY LIMITED ACCESS S.R 29  
N. 88° 35' 05" W. ~ 664.26'

(CONC. MON.)  
RIGHT-OF-WAY OF HARRIS ROAD

LEGEND

- "A" Stone found at N.W. corner of S.W. 1/4 of Sec. 36
- "B" Stone found at N.E. corner of S.W. 1/4 of Sec. 36
- "C" Iron bar found (see deed vol. 244, page 3)
- "D" 5/8" iron bar set.

SCALE 1" = 100'

SURVEYED BY Gordon J. Geeslin  
GORDON J. GEESLIN  
REGISTERED SURVEYOR 5372

COMM. NO. 72-19	DRAWN BY GLG	DATE 4/27/72	REVISION DATE	SHEET NO.
	CHECKED BY	Fanning & Howey ARCHITECTS & ENGINEERS P.O. BOX 71, COLUMBUS, OHIO 43260		
RABE SURVEY of part of the N.E. 1/4 of the N.E. 1/4 of the S.W. 1/4 of Sec. 36, Town 5 South, Range 3 East (Jefferson Twp.) Mercer County, Ohio				

4-27 B-55





177

1881 Owners Sec 36, T-5-S, R 3-E Jefferson Twp  
Survey Bk 3, pg 177

# ROAD RECORD

VISION  
VISION  
VISION

1

Sec 36 T-5-S R-3-E Center or Jefferson  
Notes of Survey in the West 1/2 of sec 36 T-5-S R-3-E  
on the 26<sup>th</sup> day of July 1881 at the Instance of Owners  
Chainmen Sworn Wm Lone and Peter Morgan

- B N 1/4 Post Stone by me in Survey Oct 1861. B 024 N 68 W 50 W 46 9 8 53 W 73
- C S Stone 14.10.5 Hickory 5 S 15 1/2 W 124 1/2 AM On B 18 N 44 E 99
- D Stake on N side of S. Span on R R Look out post S 20 W 16 1/2 links
- E S W cor of sec Stake on North side South rail on R R Look out Post S 46  
W 26 S being 39 Links West of corner in Town 68 R 3 E
- F W 1/4 P trees last line bracketed S. 11.8 W Oak 18 S 75 E 114 R Oak 68 S 35 E 553
- G S Stone 12.8.6 White Oak 2 S 37 W 97 Walnut S N 6 E 81 m m
- H S Stone 13.8.5 White Ash 12 S 16 1/2 W 92 Hickory 14 S 41 1/2 E 69 1/2
- I Stone Stone Witness north 50 S

The above I hereby certify correct M. Schuyler Co Sur  
on the 26<sup>th</sup> day of July 1881 at the City of New York

The above notes of survey by me are copied  
from Note Book 20, Page 144 and are correct  
Peterson July 9<sup>th</sup> 1892 Marcus Schuyler Surveyor

- B S Stone 14.10.5 Hickory 5 S 15 1/2 W 124 1/2 AM On B 18 N 44 E 99
- C Stake on N side of S. Span on R R Look out post S 20 W 16 1/2 links

That and notes of Survey made by me in the West 1/2 of S. 6 1/2  
of Sec 12 T-5-S R-3-E on the 3<sup>rd</sup> day of Sept 1881  
at the Inst. of Joseph Dees

- No 1 S. Stone in Sur of Sec 13 Burr Oak 16 N 1 W 126 9
- " 2 S. Stone 8.6.6 S. W corner of Church lot Burr Oak 6 N 82 E 11 m m
- " 3 S. Stone 11.8.5 White Elm 9 S 35 E 79 not marked
- " 4 S. Stone 10.6.6 Wild Cherry 8 S 27 W 33 1/2 " "
- " 5 Stake No 6 S. Stone 12.6.6 no trees at N. W corner of same
- " 7 Stake 80 8. Stake and Stone 1 1/4 chs north of sec line
- " 9 S. Stone and Stone 12.9.6 S. W corner of Stone wall of Brick Schoolhouse  
bears N 31 E 11 1/2 S distant

The above is correct to the best of my belief

Comp M. Schuyler Co Sur

The above notes of Survey by me are correct as copied  
from Book No 20, Page 146 this 11<sup>th</sup> day of July 1892

Marcus Schuyler Sur

Survey No. 113. Plat and Notes of Survey made by me in the NE of Sec 36 T 5 S R 3 E on the 24 day of Oct 1861. at the instance of J. Morgan also on the 25th day of Oct 1861. at the instance of Jas Morgan Charmer sworn Samuel Kelly and Joseph Blue. Scale 4 inches to a mile. Copied from note book No 4 Pages 18 to 23 inclusive

A  $\frac{1}{2}$  Post. I find the stump of Elm 16 N 56 W 48. standing high marked and P. Ash 8 S 33 W 40 standing green. door stake and marked Elm 18 N 32 E 4.

B NE corner of sec. I find the Sugar 12 S 44 W 75 standing green marked Planted stake and Lime stone 13 9.2 marked White Ash 6 S 83 W 84

C  $\frac{1}{4}$  Post. I find a stone corner correct Burr Oak 15 S 17 E 18 lying down. marked new Burr Oak 24 N 6 S W 50 White Ash 9 S 53 W 73.

D center of sec. made at the point of intersection of right lines from the 4 Posts. Stake deep and stone 16.8.6 marked Burr Oak 8 N 44 E 99 North

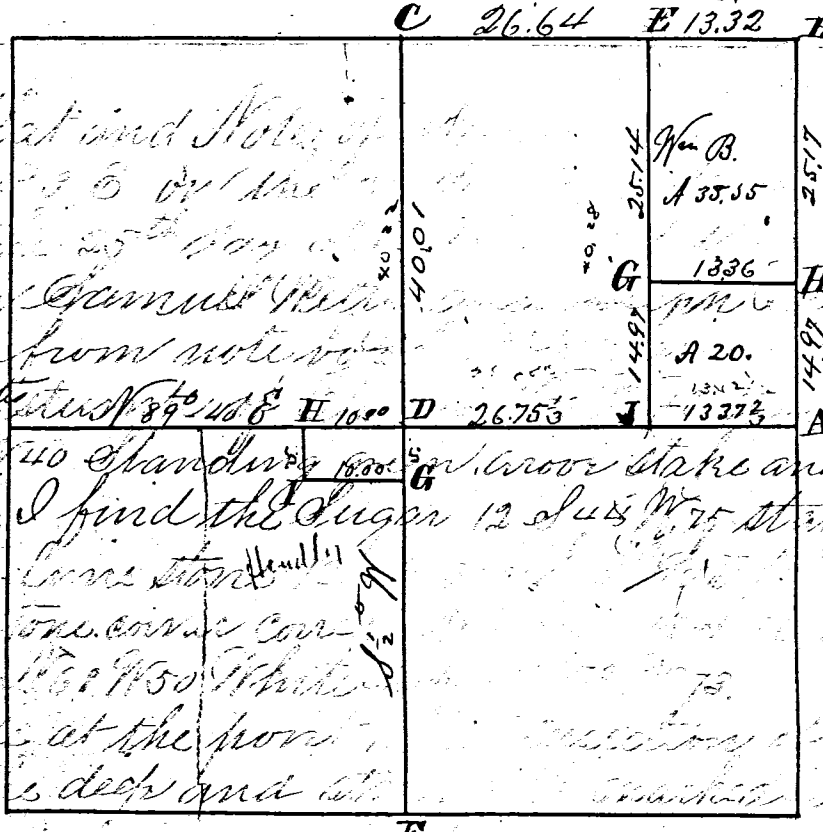

197 Survey No. 113. Plat and Notes of Survey made by me in the NE of Sec 36 T 5 S R 3 E on the 24 day of Oct 1861. at the instance of J. Morgan also on the 25th day of Oct 1861. at the instance of Jas Morgan Charmer sworn Samuel Kelly and Joseph Blue. Scale 4 inches to a mile. Copied from note book No 4 Pages 18 to 23 inclusive

A  $\frac{1}{2}$  Post. I find the stump of Elm 16 N 56 W 48. standing high marked and P. Ash 8 S 33 W 40 standing green. door stake and marked Elm 18 N 32 E 4.

B NE corner of sec. I find the Sugar 12 S 44 W 75 standing green marked Planted stake and Lime stone 13 9.2 marked White Ash 6 S 83 W 84

C  $\frac{1}{4}$  Post. I find a stone corner correct Burr Oak 15 S 17 E 18 lying down. marked new Burr Oak 24 N 6 S W 50 White Ash 9 S 53 W 73.

D center of sec. made at the point of intersection of right lines from the 4 Posts. Stake deep and stone 16.8.6 marked Burr Oak 8 N 44 E 99 North

E stake and Lime stone 16.9.2 marked White Oak 9 S 53 W 74 White Ash 9 S 18 E 22

F  $\frac{1}{2}$  Post. I find the stump of Beech 10 N 36 W 9 roots of W Ash 12 N 33 E 15 A. C Planted Stake and Stone 16.14.9 marked Hichory 18 S 86 E 122.

G on NE  $\frac{1}{4}$  Stake and Stone 13.6.3 14  $\frac{97}{100}$  Chest of I W Oak 4 N 12 E 13 Lym 6 S 55 E 52

H on East line Stake and Lime Stone 16.6.3 Beech 20 S 2 W 33 Hichory 12 West 4

I Stake on E & W center line 13  $\frac{373}{100}$  chains west of East quarter Post at A

Notes of corners in the SW  $\frac{1}{4}$  of sec surveyed for Jas Morgan

G 5 chains S  $\frac{1}{2}$  W from D Stake and Stone 14.6.6 marked Red Oak 24 S 39 E 332

H 40 chains N of D Stake and Stone 8.8.4 marked White Ash 8 S 54 W 53 122 64

I 5 chains S  $\frac{1}{2}$  W from H and 10 chains S 89 40 W from G Stake and Stone 13.7.4 marked Black Ash 4 N 45 E 12 Burr Oak 10 N 32 E 22.

I hereby certify the above to be correct.

Surveyor's Office Lehigh Ohio March 9<sup>th</sup> 1864

Maicus Schuyler to Surveyor of Mercer Co Ohio

Copied from Old Record by J. M. Ford

E. J. Sawyer Jan 25<sup>th</sup> 1889

F  $\frac{1}{2}$  Post

G on NE  $\frac{1}{4}$  Stake and Stone

H on East line Stake and Lime Stone

I Stake on E & W center line

G 5 chains S  $\frac{1}{2}$  W from D Stake and Stone

H 40 chains N of D Stake and Stone

I 5 chains S  $\frac{1}{2}$  W from H and 10 chains S 89 40 W from G Stake and Stone

I hereby certify the above to be correct.



Book #2 Jefferson

SURVEY No. 58 In Town 8 of Range 3 East. Plat and Notes of Survey made by me on the 9 day of March, A. D. 1874, in Sec. 36, Town 8, of Range 3, at the instance of Patrick Harmon et al

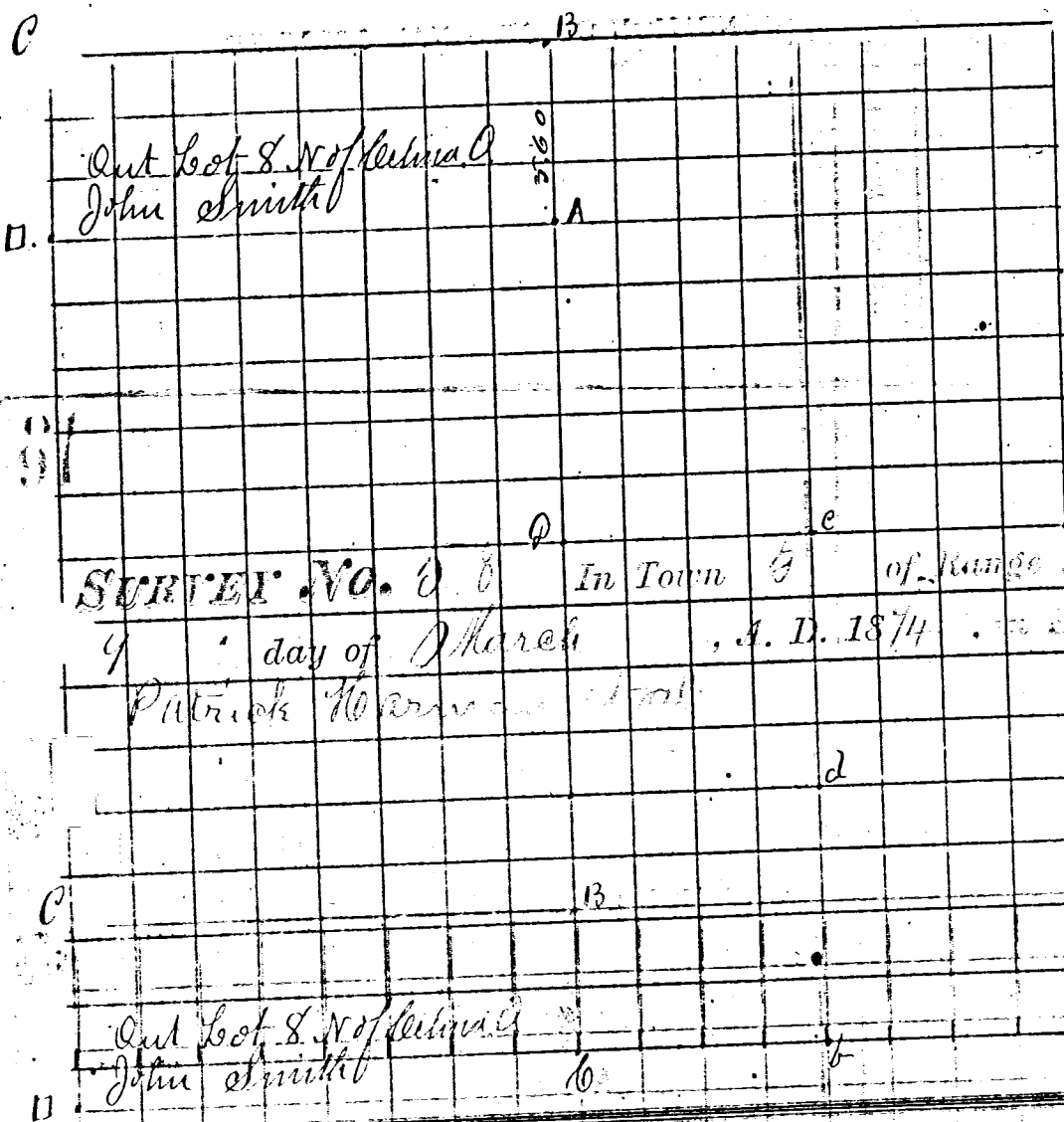

CONDITION OF ORIGINAL CORNERS.

I find B Ash down, but find notch in the stump and find the stump of the Elm both of the original notes.

SURVEY No. 60 In Town 8 of Range 3 East. Plat and Notes of Survey made by me on the 9 day of March, A. D. 1874, in Sec. 36, Town 8, of Range 3, at the instance of Patrick Harmon et al

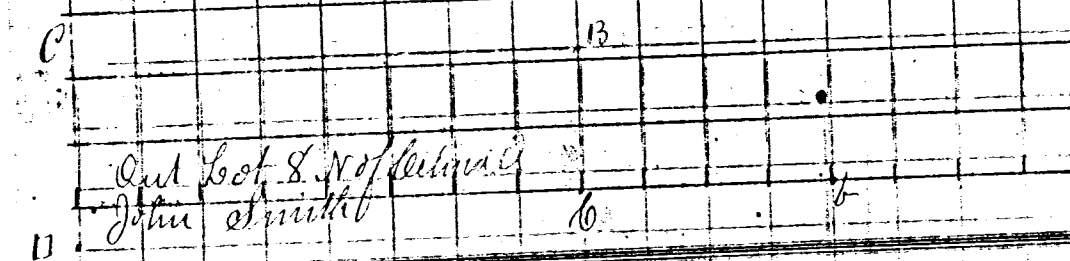

CONDITION OF ORIGINAL CORNERS.

I find B Ash down, but find notch in the stump and find the stump of the Elm both of the original notes.

CORNERS DESCRIBED.	BEARING TREES.	D.	Course.	Dist.	BEARING TREES.	D.	Course.	Dist.
a 1/4 Post Office Stone 18x10x8	Hickory	8	S12W	41	Hickory	18	S33E	52 1/2
a NW cor. of S 1/4 of S 1/4 Stone 15x11x8	Hickory	8	S5 1/2 W	15	Hickory	8	N69E	44
b S.W. cor. of S 1/4 of S 1/4 Stone	Red Oak	24	N4E	50	Beech	18	S58 1/2 E	28
c NW cor. of S 1/4 of S 1/4 Stone 14x9x8	Beech of Range	19	S 1/2 W	32	Elms	10	S46 1/2 W	57
d Center of S 1/4 of S 1/4 Stone 16x8x7	White Oak	13	N16E	35 1/2	Hickory	5	S25 1/2 W	27
9 Cent of section 12x9x5 granite B O		15	N44E	99				

I certify the above to be correct to the best of my knowledge and belief

J. Randabaugh County Surveyor

CONDITION OF ORIGINAL CORNERS.

Out lot 8 N of Sec 36 Survey No. 60, Out lot 8 N of Sec 36 Ohio in Sec. 36 T5 R2, at the instance of John Smith

CORNERS DESCRIBED.	BEARING TREES.	D.	Course.	Dist.	BEARING TREES.	D.	Course.	Dist.
A S. E. Cor. find stone and stump of original witness tree agreeing therewith as noted in the Survey made in laying out the lot.	Hickory	8	S89E	103	White Oak	14	S77E	142
B Stone at N.E. cor. 17x7x3 line	Elm	15	S37E	54				
C Stone at N.W. cor. 16x9x2 1/2 "	Quaking Asp	12	S75E	44	White Oak	8	S89E	94
D Stone at S.W. cor. 15x8x2 "								

I certify the above to be correct to the best of my knowledge and belief

J. Randabaugh County Surveyor

CONDITION OF ORIGINAL CORNERS.

# SURVEY FOR MSK PARTNERSHIP

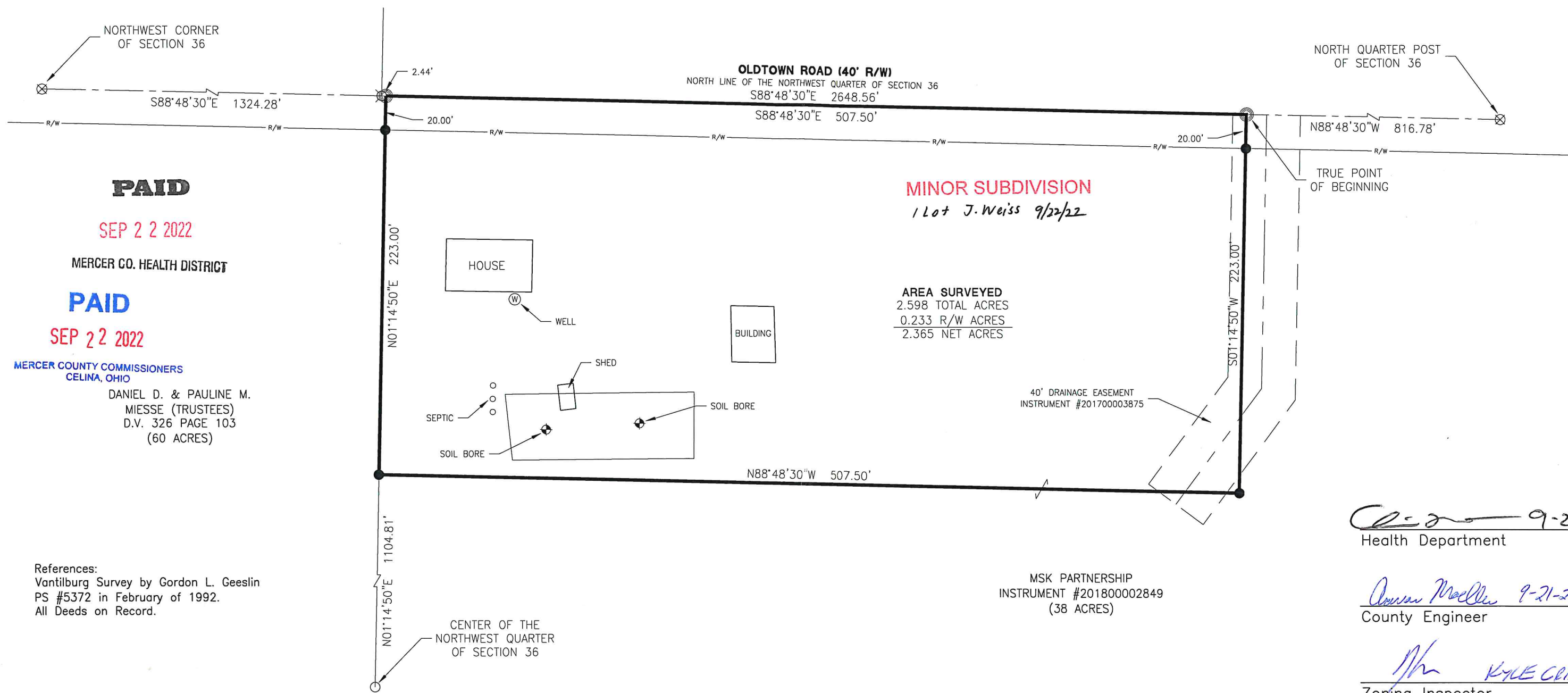

References:  
Vantilburg Survey by Gordon L. Geeslin  
PS #5372 in February of 1992.  
All Deeds on Record.

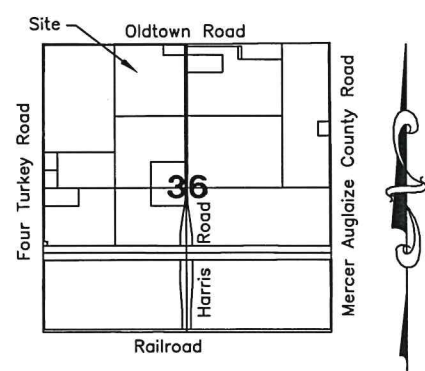

**LEGEND**

- ⊗ RR Spike Found
- Iron Pin Found
- Iron Pin Set
- ⊙ Mag Nail Set
- ⊗ Mag Nail Found
- Con Mon. Found
- △ Section Corner

Surveyed By: *[Signature]*  
Craig W. Mescher Reg. Surveyor No. 8237

Scale: 1" = 60'

PROJECT # 222808.86

**ACCESS**  
Engineering Solutions  
1200 IRMSCHER BLVD., SUITE B, CELINA, OH 45822  
www.accessengllc.com | 419-586-1430

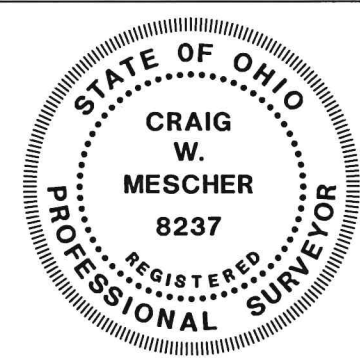

Basis of Bearings:  
Mercer County Local Coordinate Datum.

State of: Ohio County: Mercer  
Township: Jefferson  
Sec.: NW 1/4 36 Town: 5S Range: 3E  
Deed Ref.: Instrument #201800002849  
Date Surveyed: September 2, 2022



# SURVEY FOR MSK PARTNERSHIP

*[Signature]* 9-22-22  
Health Department

*Ana Moeller* 9-21-22  
County Engineer

*[Signature]* 9-15-22  
*Kyle Gray*  
Zoning Inspector

References:  
Vantilburg Survey by Gordon L. Geeslin  
PS #5372 in February of 1992.  
Dicke Survey by James W. Geeslin PS  
#7764 in February of 2005.  
Hut/Keefer Survey by James W. Geeslin  
PS #7764 in September of 2016.  
All Deeds on Record.

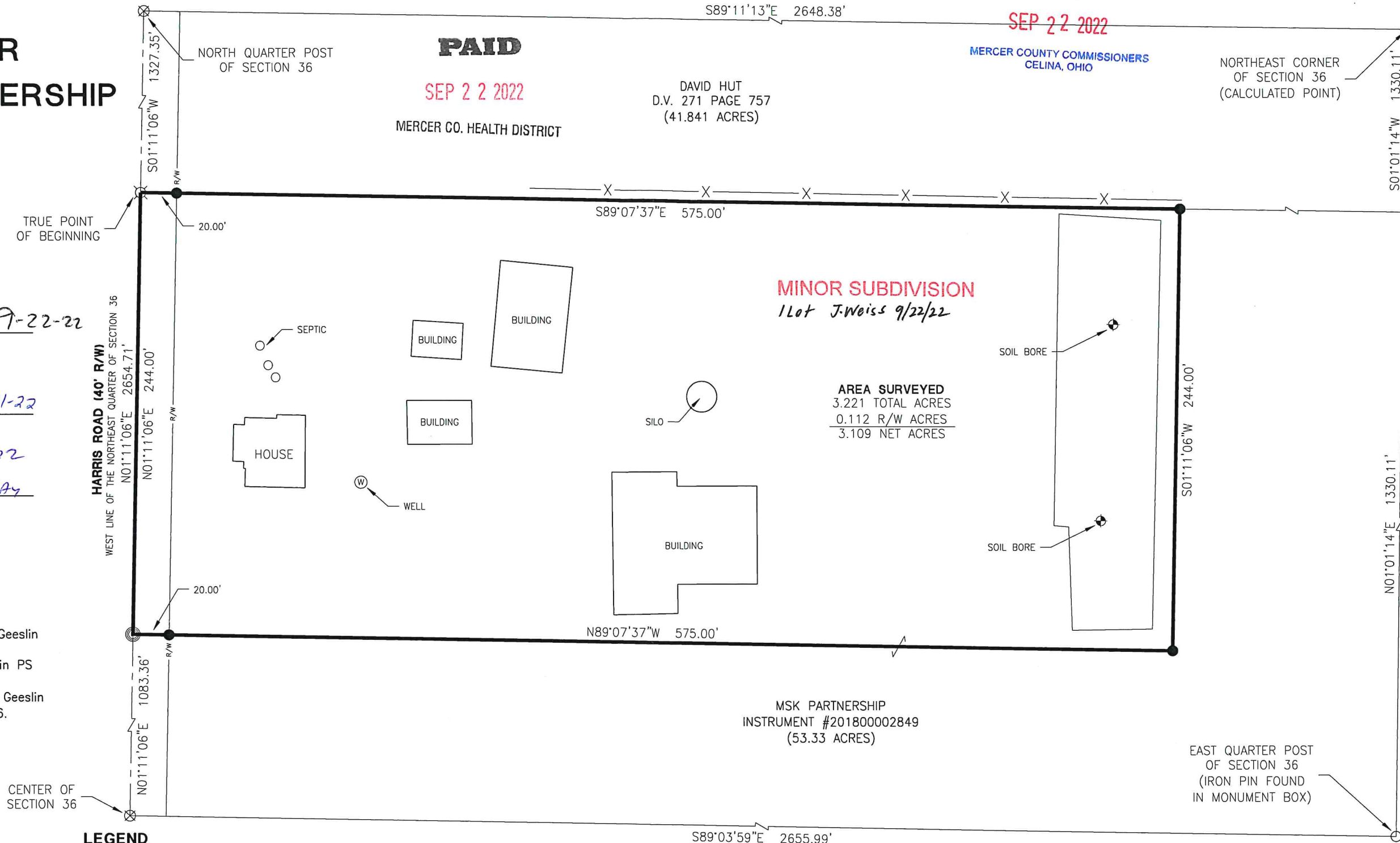

### LEGEND

- ⊗ RR Spike Found
- Iron Pin Found
- Iron Pin Set
- ⊙ Mag Nail Set
- ⊗ Mag Nail Found
- Con Mon. Found
- △ Section Corner

Surveyed By: *[Signature]*  
Craig W. Mescher Reg. Surveyor No. 8237

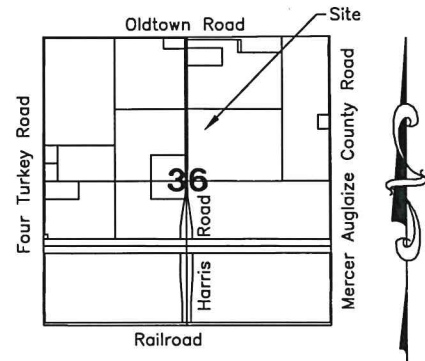

Scale: 1" = 60'

PROJECT # 222808.87

**ACCESS**  
Engineering Solutions

1200 IRMSCHER BLVD., SUITE B, CELINA, OH 45822  
www.accessengllc.com | 419-586-1430

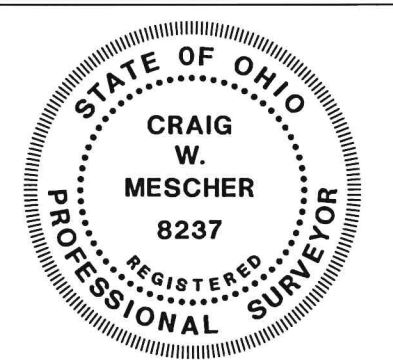

Basis of Bearings:  
Mercer County Local Coordinate Datum.

State of: Ohio County: Mercer  
Township: Jefferson  
Sec.: NE 1/4 36 Town: 5S Range: 3E  
Deed Ref.: Instrument #201800002849  
Date Surveyed: September 2, 2022

PAID

06-36-200-

SEP 2 2 2022

PAID

SEP 2 2 2022

MERCER COUNTY COMMISSIONERS  
CELINA, OHIO

DAVID HUT  
D.V. 271 PAGE 757  
(41.841 ACRES)

NORTHEAST CORNER  
OF SECTION 36  
(CALCULATED POINT)

MINOR SUBDIVISION  
1 Lot J. Weiss 9/22/22

AREA SURVEYED  
3.221 TOTAL ACRES  
0.112 R/W ACRES  
3.109 NET ACRES

MSK PARTNERSHIP  
INSTRUMENT #201800002849  
(53.33 ACRES)