

06-B ✓
 06-03-100-009
 06-03-100-008

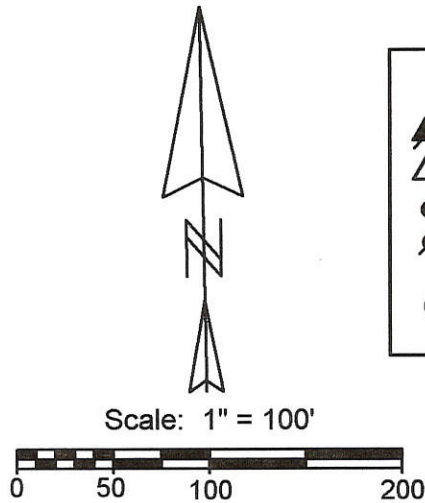

- Legend:**
- ▲ Cornerstone @ the NW corner of Section 3
 - △ Mag nail set @ the W1/4 post of Section 3
 - 5/8" X 30" Iron pin w/cap set
 - ⊙ 5/8" X 30" Iron pin w/cap set on line and 30.00' from corner
 - Mag nail set

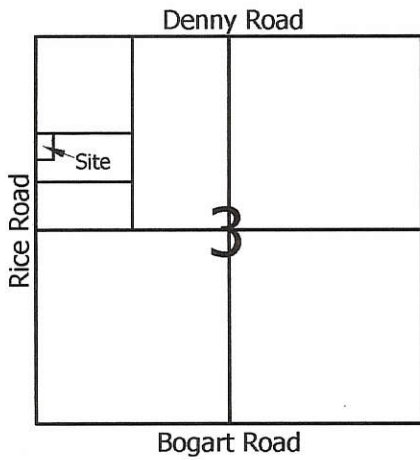
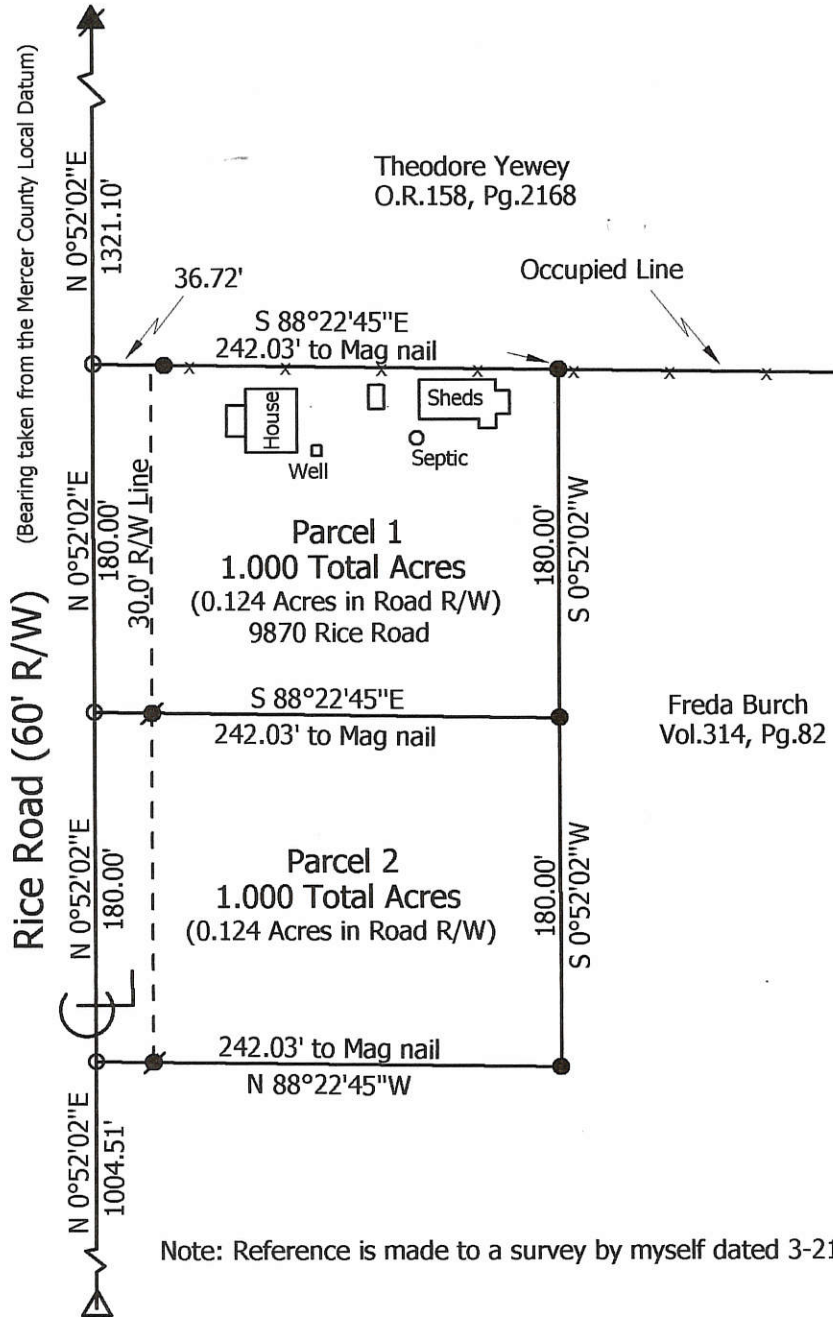

Note: Reference is made to a survey by myself dated 3-21-05

**Marbaugh
 Land Surveying**

1210 Yorkshire Court
 Celina, Ohio 45822
 (419) 586-4293



Kent Marbaugh
 Kent B. Marbaugh P.S.7421

Freda Burch Estate Survey

State of: Ohio County: Mercer
 Township: Center Sec: 3 Town: 5S Range: 3E
 City/Village: _____ Subdivision: _____ Lot: _____
 Deed Ref: Vol.314, Pg.82 Date Surveyed: 4-9-05

Approvals: _____
 Agency: Board of Health Township Zoning Inspector _____ County Engineer _____
 Date: _____

LEGEND

- "A" = STONE № 1088 AT N. ¼ POST ~ SEC. 3.
- "B" = IRON PIPE AT S.W. COR. ~ SECTION 34, UNION TWP.
- = NINE SPIKE SET.
- = 5/8" X 30" IRON BAR SET.

LOCATION SKETCH

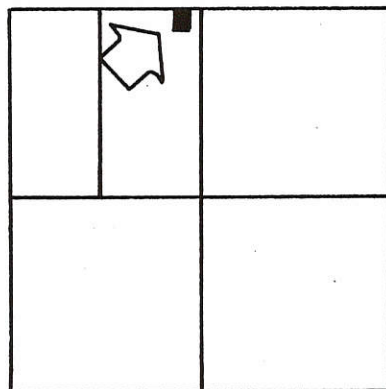

SECTION 3

NOTE

THE N. LINE OF THE N.W. ¼ OF SECTION 3 WAS ASSUMED TO BEAR EAST-WEST. ALL OTHER BEARINGS ARE BASED ON ANGLES TURNED.

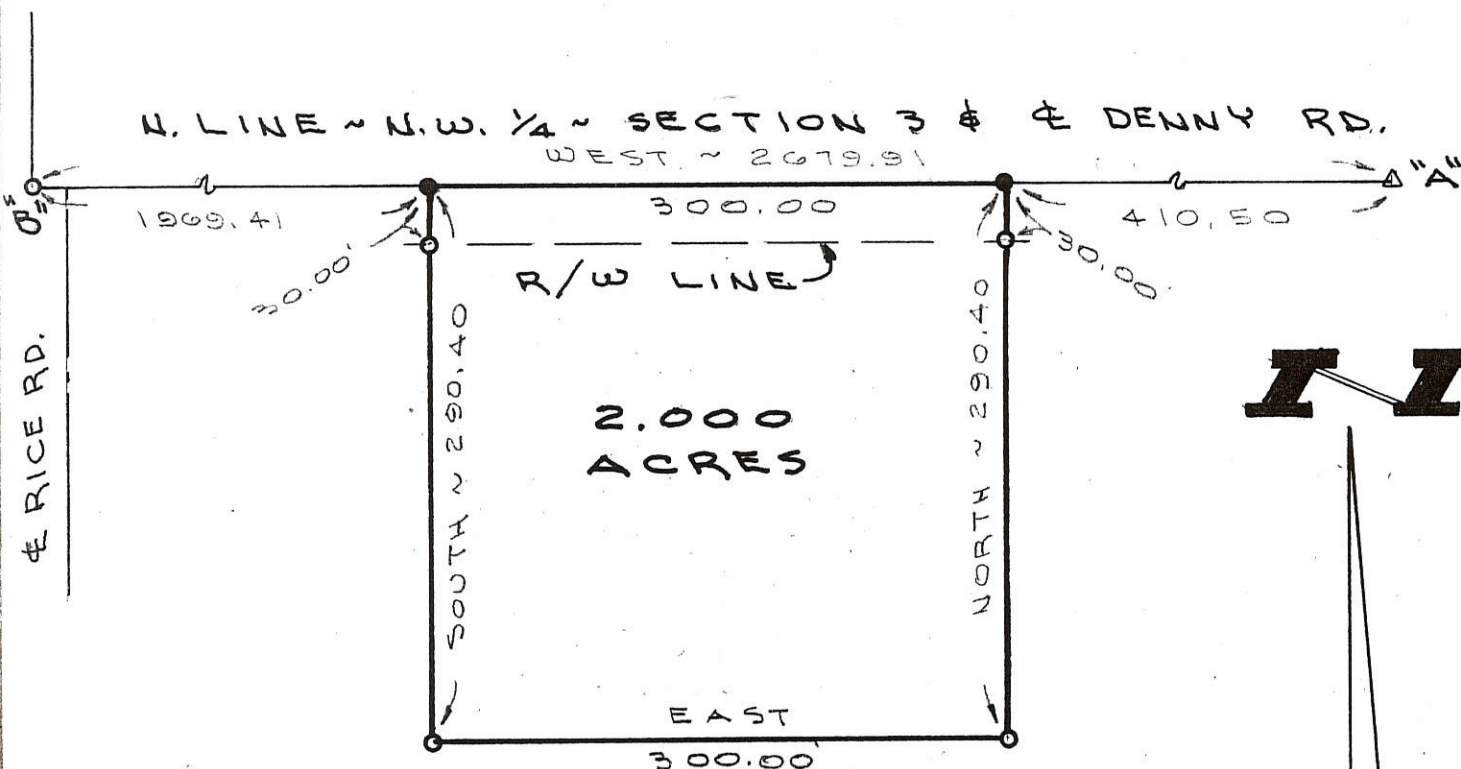

SURVEYED BY Gordon L. Geeslin
 GORDON L. GEESLIN
 REGISTERED SURVEYOR
 № 5372

JORDAN SURVEY

PART OF THE E. ½ OF THE N.W. ¼ OF SEC. 3,
 TOWN 5 SOUTH, RANGE 3 EAST (CENTER
 TOWNSHIP), MERCER COUNTY, OHIO.
 AUGUST 12, 1992 SCALE 1"=100'



GORDON L. GEESLIN
 LAND SURVEYOR
 810 EAST MARKET STREET
 CELINA, OHIO
 PHONE (419) 586-6155



PERMANENT PARCEL No. _____

Part of: _____ Sec. _____ T _____ R _____ Township

Grantor: _____ Area Retained: _____ Acres

Grantee: _____ Area Transferred: _____ Acres

Deed References: _____

APPROVALS:
 AGENCY: _____ DATE: _____
 Board of Health _____ County Sanitary Engineer _____ County Engineer _____

Marbaugh
Land Surveying
 1210 Yorkshire Court
 Celina, Ohio 45822
 (419) 586-4293



Freda Burch Estate Survey

State of: Ohio County: Mercer
 Township: Center Sec: 3 Town: SS Range: 3E
 City/Village: _____ Subdivision: _____ Lot: _____
 Deed References: Vol. 314, Page 82 Date Surveyed: 3-21-05

Approvals:
 Agency: _____ Board of Health _____
 Date: _____ Township Zoning Inspector _____
 County Engineer _____

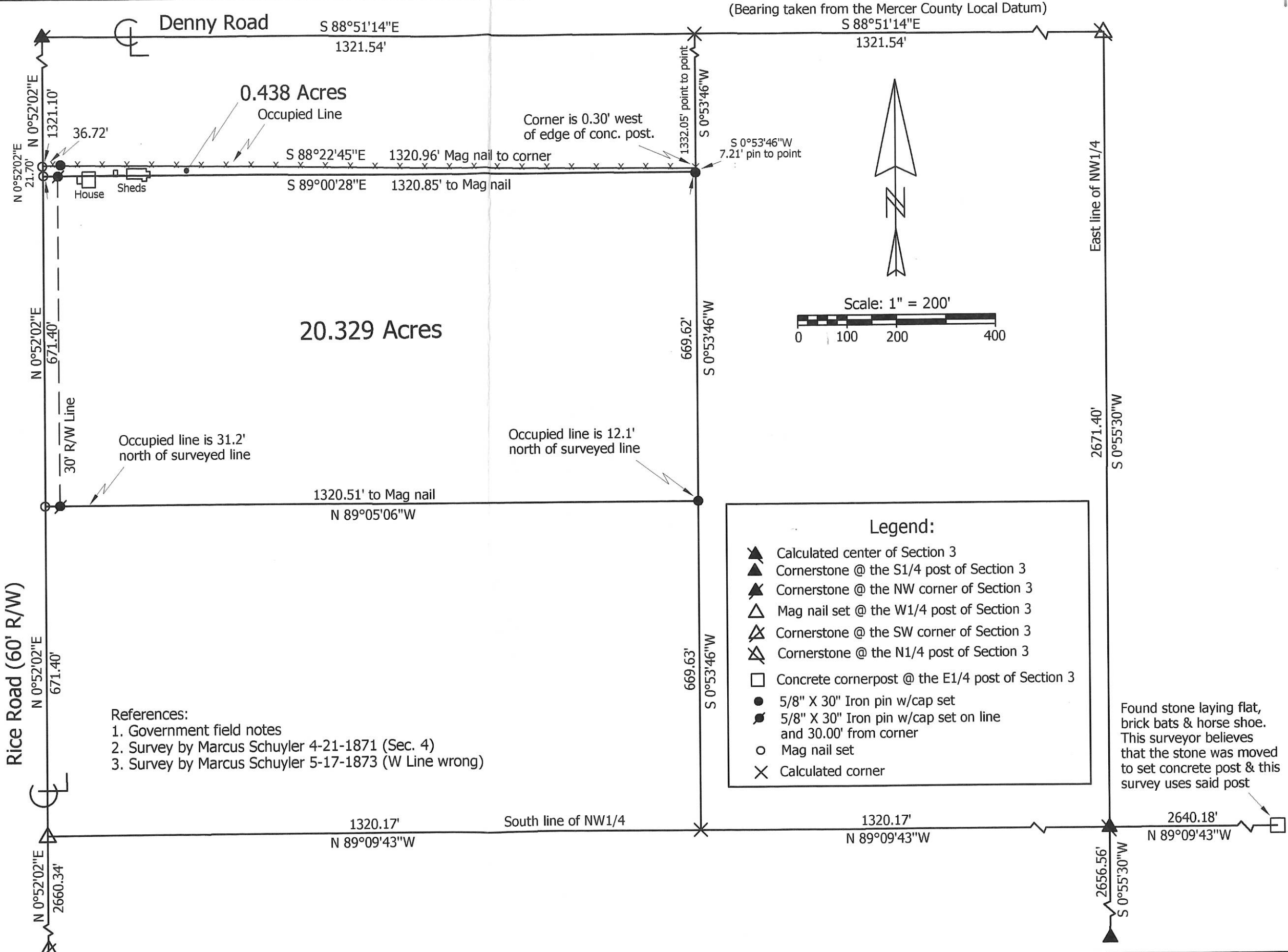

06-03-100-888-001
 06-B ✓

DAVIS SURVEY
 PART E¹/₂ NE¹/₄, SEC. 3, T55, R3E, CENTER TWP.
 MERCER COUNTY, OHIO

06-B ✓
 06-053-200-
 003
 -004
 -007

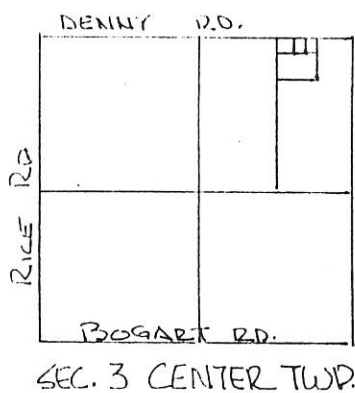

SCALE 1" = 100'



DEED REF: VOL. 200 PG. 435
 VOL. 288 PG. 54

LEGEND

- △ STONE REF
- SPIKE FOUND
- NAIL SET
- IRON PIN SET
- IRON PIN FOUND

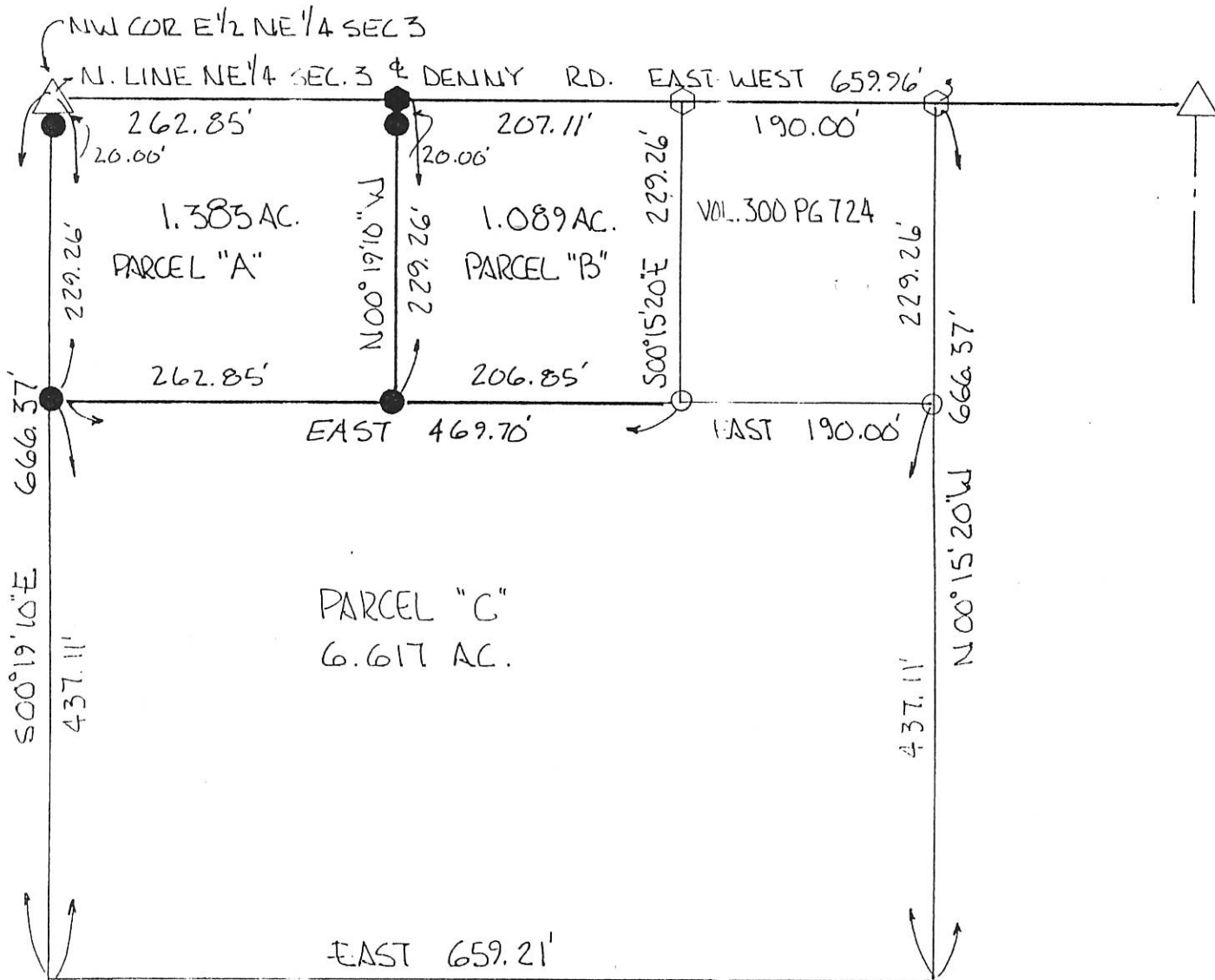

NO PIN SET LAND UNDER CULTIVATION,
 BEARINGS TURNED FROM N. LINE NE¹/₄
 SEC. 3, & DENNY RD ASSUMED
 EAST-WEST.

PLAT BY SURVEY JUNE 1998

Roy F. Thompson, Jr.
 ROY F. THOMPSON JR. REG. SUR # 5379

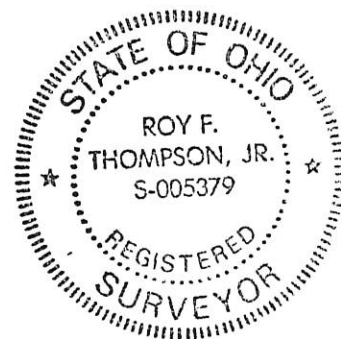

CENT. COR POST

PERMANENT PARCEL No.		
Part of:	E ¹ / ₂ NE ¹ / ₄ sec. 3 T55 R3E CENTER Township	
Grantor:	DAVIS	Area Retained: 0 Acres
Grantee:		Area Transferred: Acres
Deed References:	Vol 200 Pg 435, Vol 288 Pg 54	
APPROVALS:	<i>Michelle Kimmel</i>	<i>Helen Davis</i>
AGENCY:	Board of Health	Co. Sanitary Engineer
DATE:	6/11/98	County Engineer

PART OF THE NORTHWEST QUARTER OF THE
 NORTHEAST QUARTER OF THE NORTHEAST
 QUARTER OF SECTION 3, T55-R3E,
 CENTER TOWNSHIP, MERCER CO., OHIO

HENRY HEMBREE
 7924 DENNY ROAD
 MENDON, OHIO

VICINITY MAP 06-03-200-004 06-B

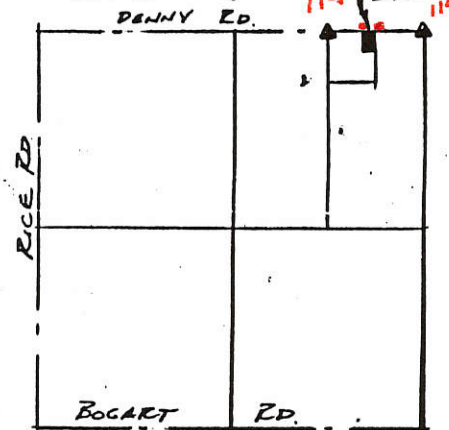

SEC. 3, T55-R3E,
 CENTER TOWNSHIP
 MERCER CO., OHIO

BEARING FOR DENNY ROAD
 ASSUMED DUE EAST - WEST

LEGEND

- "A" - $\frac{3}{8}$ " ϕ RE-ROD OVER STONE FOUND
- "B" - R.R. SPIKE SET
- "C" - $\frac{1}{2}$ " ϕ RE-ROD SET

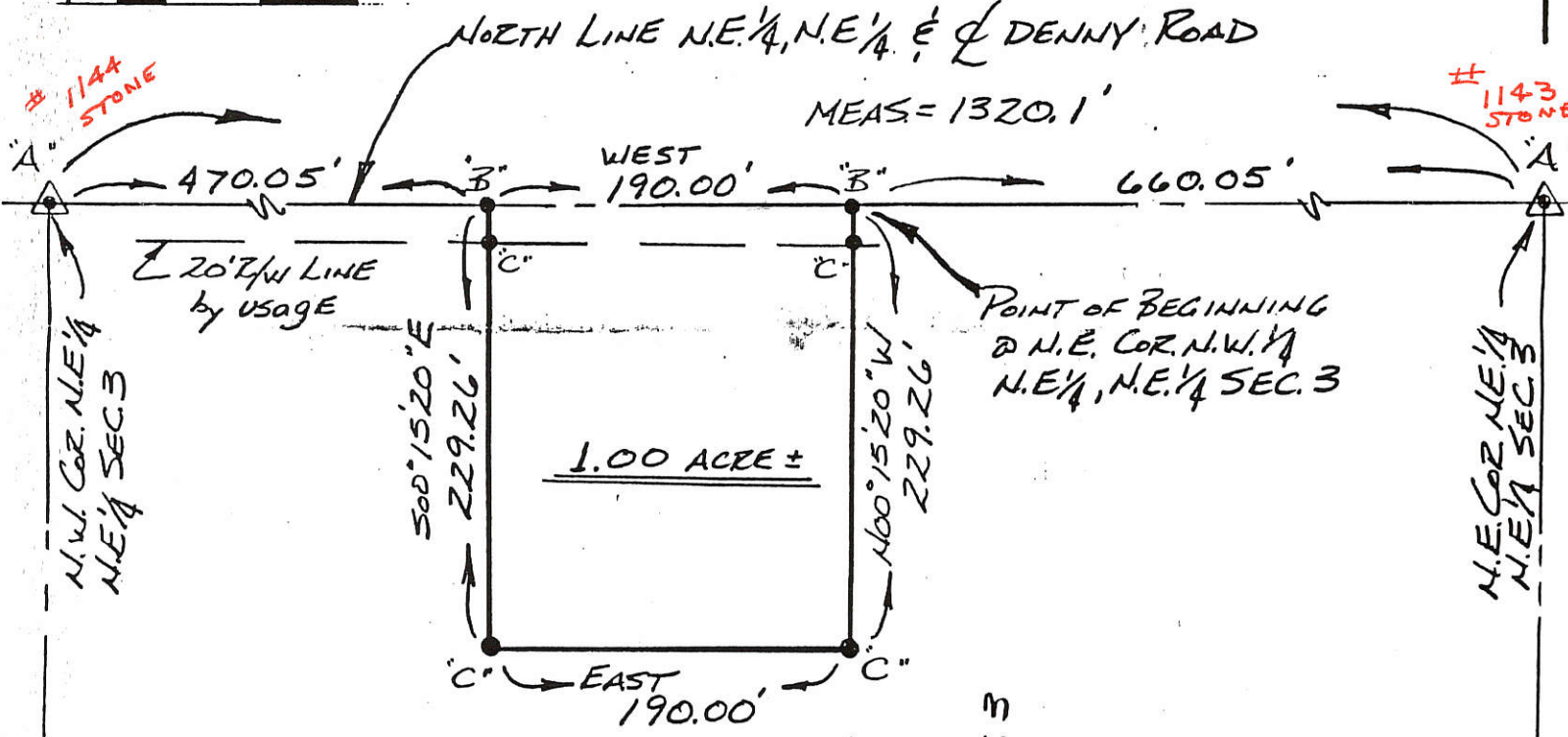
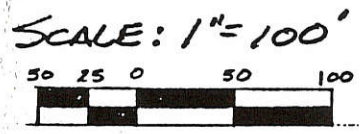

DAVIS
 DEED VOL. 288 Pg. 54
200 435

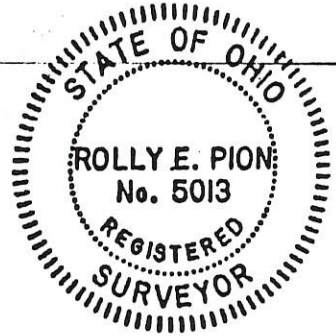

MUHLENKAMP
 DEED VOL. 240 Pg. 116

Rolly Pion
 ROLLY E. PION
 R.L.S. # 5013

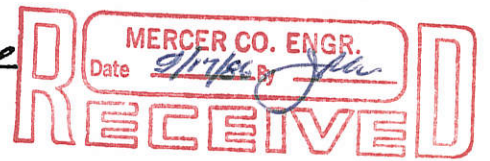
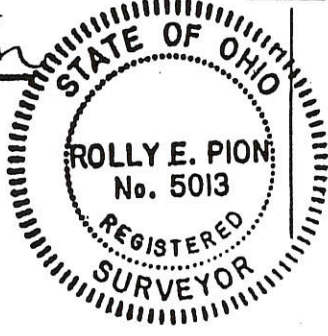

CONCRETE
 CORNER POST

WOOD CORNER
 POST

MEAS: 1315.4'

FILED IN SURVEY BOOK

Survey of part of parcel 0603400001 located in the SW 1/4 of Section 3, T5S, R3E, Center Township, Mercer County, Ohio.

Prior Deed referenced in Vol. 211, Page 316.



SCALE: 1" = 100'

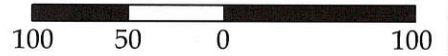

GRAPHIC SCALE

Legend

- A = Existing Survey Marker at the SE corner of the SW 1/4 of Section 3, Point #6038 of the MERCER COUNTY LOCAL COORDINATE DATUM
- B = Existing Survey Marker at the SW corner of Section 3, Point #6049 of the MERCER COUNTY LOCAL COORDINATE DATUM
- C = Set MAG Nail
- D = Set #5 Rebar

Note:

All distances called out on this plat are measured distances, unless otherwise noted.

- ① N 37°-16'-28" E ~ 105.80'
- ② N 75°-22'-28" E ~ 54.30'
- ③ S 83°-01'-32" E ~ 68.80'
- ④ S 65°-49'-32" E ~ 81.90'
- ⑤ S 46°-49'-32" E ~ 142.06'

Approved by:

Vernon C. Eifler 4-15-08
Mercer County Engineer

Chad Moore 4-15-08
Mercer County Health Department

Dave Stokes
Center Township Zoning Official

Harry W. & Naomi M. Krogman
Vol. 211, Page 316

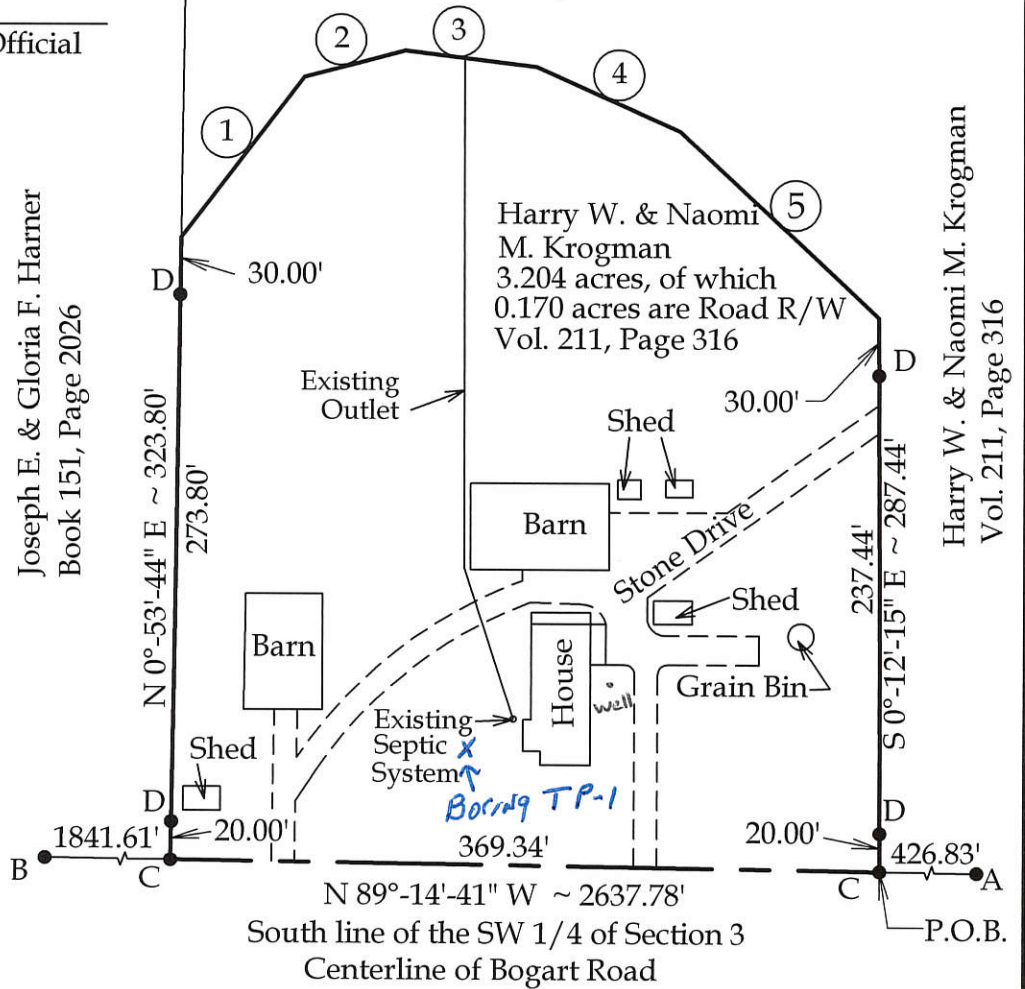

Joseph E. & Gloria F. Harner
Book 151, Page 2026

Harry W. & Naomi M. Krogman
Vol. 211, Page 316



This plat and the accompanying legal description represent an actual boundary survey completed under my direct supervision on March 25, 2008.

Brad J. Core
Brad J. Core, P.S. #8004

MINOR SUBDIVISION

CORE CONSULTING A DIVISION OF MATERIALS TESTING, INC. 1660 S. DEFIANCE TRAIL SPENCERVILLE, OHIO 45887 (419) 647-6163			
CLIENT: Ed Krogman			
SURVEYED BY: G.A.D.	DATE: 3-24-2008	DRAWN BY: J.L.S.	CHECKED BY: B.J.C.
SCALE: 1" = 100'	PAGE 1	OF	PAGES 2

0603300004

06-B(3)

LEITZELL-HILES SURVEY

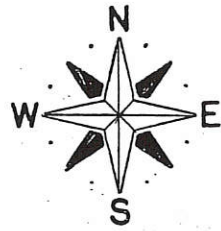
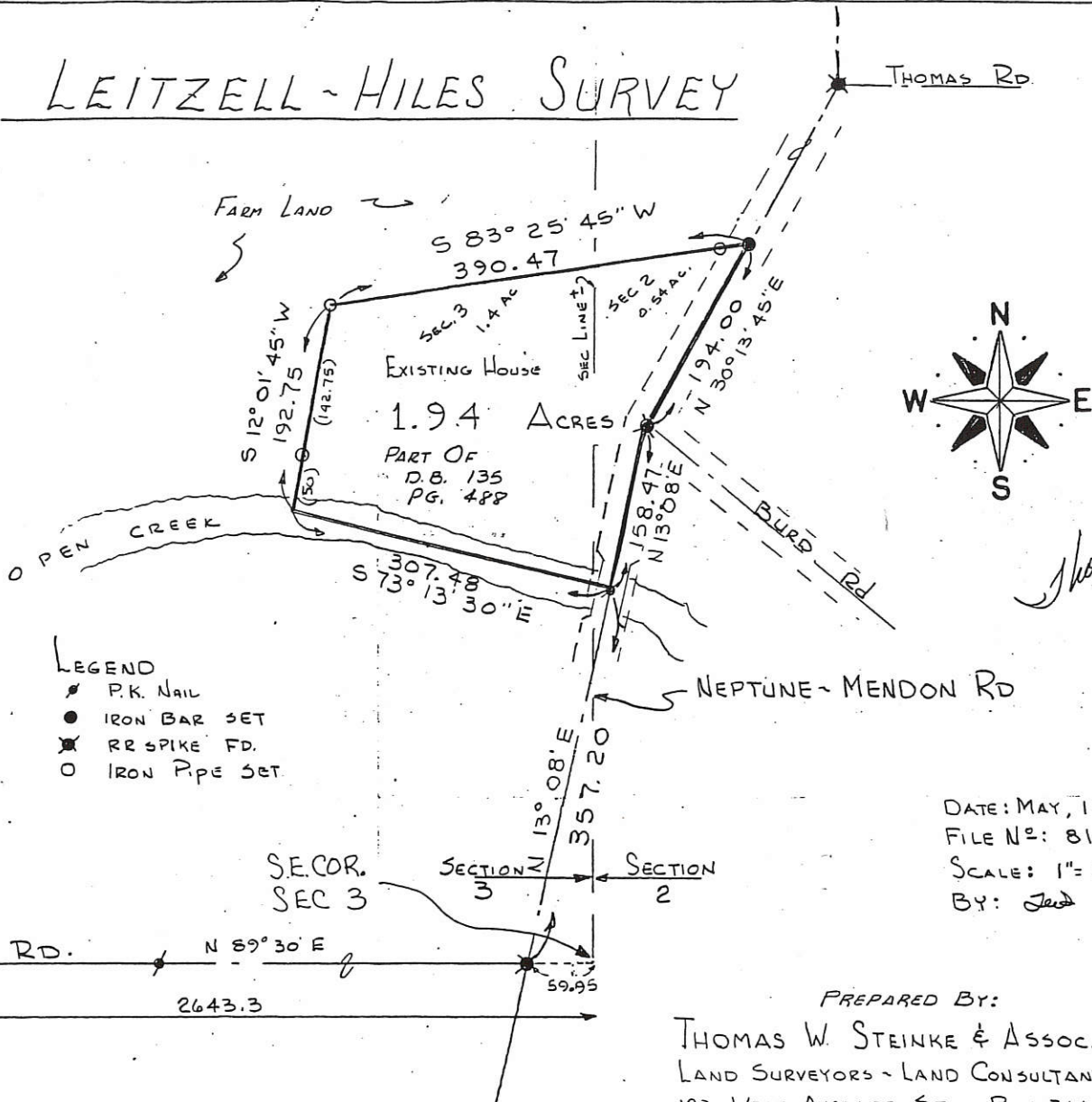

- LEGEND**
- P.K. Nail
 - IRON BAR SET
 - ✱ RR SPIKE FD.
 - IRON PIPE SET

Thomas W. Steinke

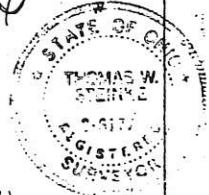

DATE: MAY, 1981
 FILE NO: 81-1089
 SCALE: 1" = 100'
 BY: *JS*

PREPARED BY:
THOMAS W. STEINKE & ASSOC.
 LAND SURVEYORS - LAND CONSULTANTS
 123 WEST AUGLAIRE ST Box 366

06-03-400-003
 06-02-300-005

06-B

MERCER COUNTY.

143

Expanded on Page 66

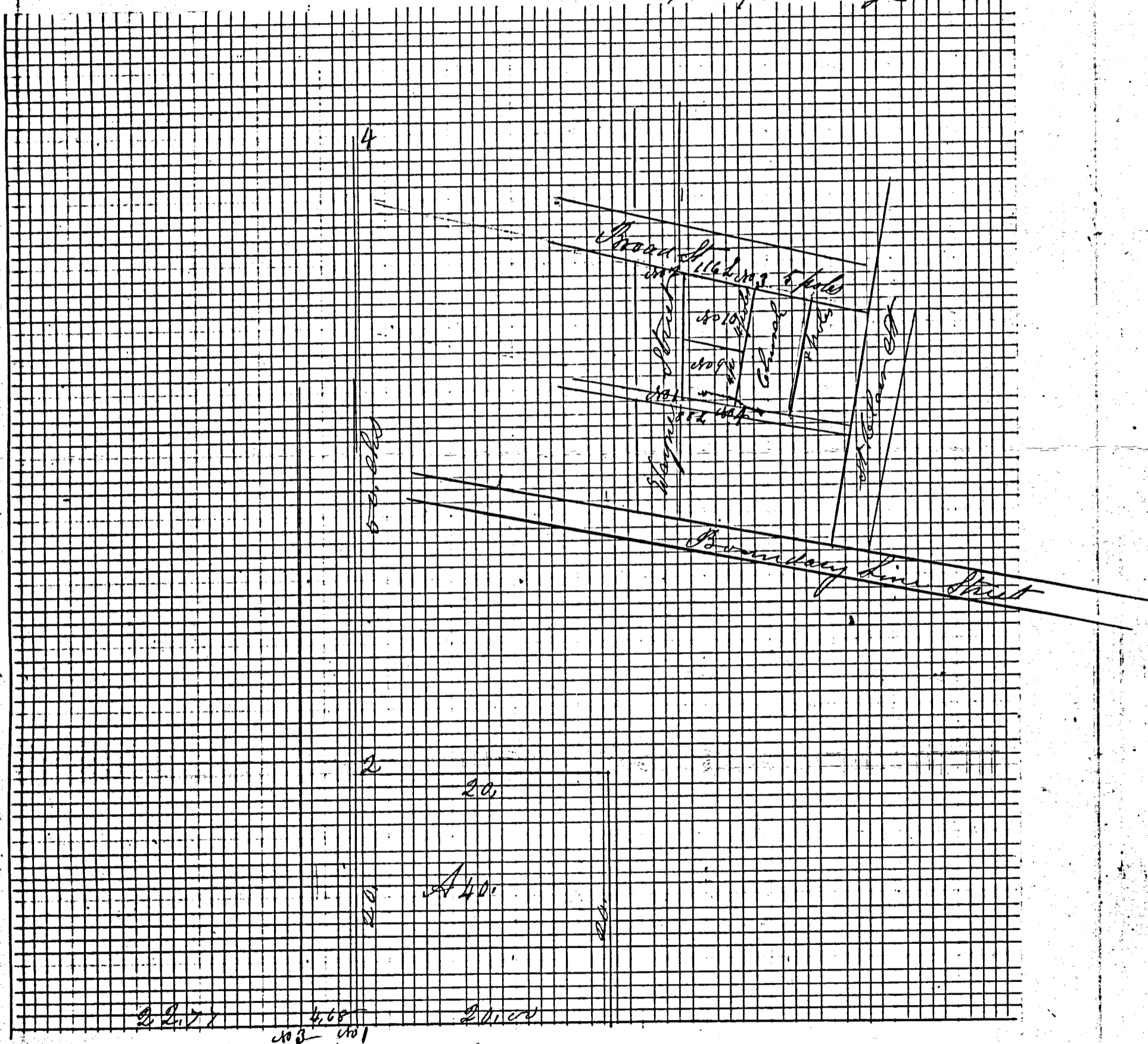

Expanded

Notes of Survey made by me in the town of Recovery, Recovery
 side on the 1st day of June 1880 in Sublots 9 & 10.
 No 1 I planted a stone at the S.W. corner of Lot No 9 as follows S to Limestone 22.11.11
 No 2 S to S Stone 17.6.2 1/2 No 3 S to S Stone 16.5.2 1/2 No 4 S to S Stone 16.6.2 1/2 inches
 The above is correct to the best of my belief
 M Schuyler
 of Mercer Co Pa
 Copied from note book 20 Page 102
 Belina Oct 1892 M Schuyler
 18

13

1871 Andrew Snavelly et al, Sec 3, T-5-S, R-3-E Center Twp
Survey Blk 3, pg 143

ROAD RECORD

Sec 3 T 5 S. R 3 E Center Township
Notes of Survey made by me on the south line of Sec 3 T 5 S
Range 3 E on the 22nd day of April 1871 at the Instance of
Andrew Snavelly Chairman Sworn Moses Townsend & Jas Newland
The line is 79.79 chains

A 19.94 1/2 B 19.94 1/2 C 19.94 1/2 D 19.94 1/2 E

- A at S.W. corner of Sec 3 T 5 S. R 3 E I find Stone corner correct & marked
Elm 6 at 26 W 83 1/2 not marked
- B Sub Stone no trees
- C 1/2 Post old trees lost line bisected Sub Stone 18.6.4
Burr Oak 8 S 1/2 E 29 1/2 Sweet Oak 15 S 60 W 89
- D Sub Stone line 15.6.3 Walnut 12 N 10 W 122 1/2 Burr Oak 18 S 84 W 92
- E S E corner of Sec I find Stumps of W Oak 13 N 27 W 11 some marked
also Roots of Elm 16 S 73 E 37 Plainly appearing Sub Stone 18.7.6
Planted a Stone witness 18.3.2 N 18 W 50
Indeped

Plat and notes of survey made by me in Sec 19
T 6 S. R 3 E on the 13th day of Aug 1869 at the Inst
of Christian Smith and George Harsher Chairman Sworn
Benadict Palmer and

- No 1 Stake and Stone 17.10.8 Walnut 4 S 73 1/2 W 13
- " 2 Stake Beech 14 S 11 E 38
- " 3 Stake White Ash 7 N 29 E 47 1/2
- " 4 Stake 70 chains north of South line of Sec.
Burr Oak 9 South 15 links or 10 feet

Copied from note Book 4 Page 89 and is correct
to the best of my knowledge and belief

Celina Aug 20th 1892

Marcus Schuyler Surveyor

1873 Samuel Davis et al, Sec 3, T-5-S, R-3-E. Center Twp

Survey BK 3, Pg 106

MERCER COUNTY.

06-B
106-B

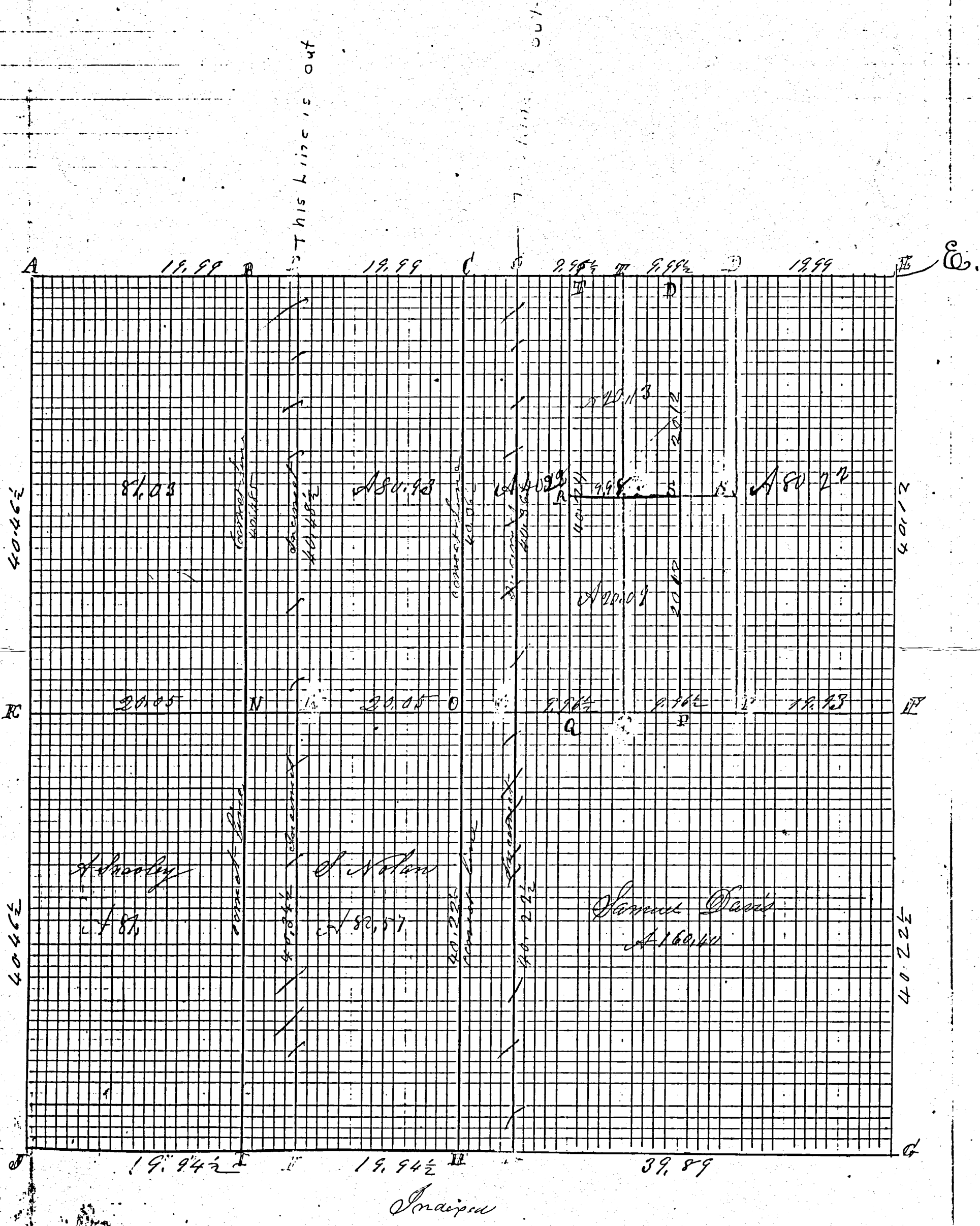

ROAD RECORD

106-A

Sec 3 T5S R3E Center Township

Notes of Survey made by me in Sec 3 T5S R3E
 on the 16th and 17th days of May 1873 at the Instance
 of Samuel Davis Abraham Musselman Christian Musselman
 Andrew Sharley Samuel Nolan Chairman Philander Davis
 and James M Nolan

- A Stone 16, 10, 7 by me in former Survey 4 being 56 d E of stone corner
- B S. b. Stone 14, 9, 8 Elm 14 N 23 W 83 1/2 Elm 15 N 58 E 75 Stone corner 46 1/2
- C S. b. Stone 10, 8, 7 Elm 16 S 32 W 89 White Oak 36 N 48 W 109
- D S. b. Stone 10, 8, 6 Elm 20 S 5 W 34 1/4 Sweet Oak 30 N 46 W 89
- E Stone
- F S. b. Stone 14, 9, 8 Walnut 15 N 13 E 183 Elm 15 S 1/2 101 1/2
- G S. b. Stone 18, 7, 4 Elm 11 N 77 E 232 1/2 Stone Walnut 16, 8, 7 N 18 W 50
- H S. b. Stone 18, 6, 5 hi Burr 8 S 1/2 E 29 1/2
- I Stone
- J Stone 10 Elm N 8 W 26 W 83 1/2 (not marked) Christian
- K S. b. Stone 18, 6, 5 triangular Elm 10 N 72 W 74 1/4 Red Oak 8 N 80 E 59
- N S. b. Stone 14, 8, 4 Elm 14 N W White 18 N 836
- P Sandstone Sweet Oak 15 N W W Oak 24 N W

Copied from note Book 18 Pages 70 and 71 and
 is correct except which was erroneous and by
 me corrected on Record Sept 12th 1892

Marcus Schuyler

D. Curque.

Comp

Stone 14, 9, 8 Elm 14 N 23 W 83 1/2 Elm 15 N 58 E 75 Stone corner 46 1/2

ROAD RECORD

No DRAWING

①

Sec 3 S 5 of R 3 E
 notes of survey made by me on the south line of Sec 3
 S 5 of R 3 E on the 22nd day of April 1871 at the Instance
 of Andrew Snavely line 79.79 chains at S.W. corner find a
 stone corner correct. Chainmen sworn Moses Townsend & Jas Nowland

A 19.94 1/2 B 19.94 1/2 C 19.94 1/2 D 19.94 1/2 E

- A Stone Elm 6 N 26 W 83 1/2 not marked
 - B Stake bats and Stone no trees
 - C 1/4 Post trees lost line bisected Stake bats Lime Stone 18.6.4
 Burr Oak 8 S 2 1/2 E 29 1/2 Sweet Oak 15 S 60 W 89
 - D Stake bats and Lime Stone 15.6.3 Walnut 12 N 10 W 122 1/2 No Oak 18 S 54 E 82
 - E S.E. corner of Sec I find the stump of White Oak 13 N 27 W 11 same & marked
 Roots of Elm 16 S 73 E 87 plainly appearing Stake bats Lime Stone 18.7.4
 Stone witness 18.3.2 N 78 W 50 links distant
- The above notes were copied by me from note Book 16 P 51
 and are correct to the best of my knowledge and belief
 Belina May 17th 1892 Marcus Schuyler ex Coroner
 Comy.

Sec 33 S 15 No 2 East

Plot and notes of survey made by me in Sec 33 S 15 and No 2 East
 on the 27th 28th 29th day of April 1871 at the Instance of Theodore
 Schmitzgar. F. H. Beckman and Martin Faller Chainmen sworn
 Theodore Schmitzgar & and Job Williams

- A Stone 18.12.6 in sur sec 28 Apr 1871 Red Oak 10 N 10 E 56 20 10 S 27 W 40
 - B 1/4 Post 16.10.7 B Ash 8 S 20 E 53 White Elm 24 S 56 W 86 in sur in Sec 28 S 8 E
 - C N.E. corner of Sec Sec in Sec 28 Stone 20.14.4 B Oak 30 S 44 W 58 1/2 B Ash 10 N 33 E 33
 - D 1/4 Post trees lost line bisected Stake bats and Stone 18.11.8 inches
 Black Ash 6 S 58 W 33 Chickory 4 N 56 W 23
 - E S.E. corner of section trees lost corner made from descriptive notes
 Branch 10 links wide 11.50 chains East of corner I find Swamp Ash Oak
 40 lying down 13.28 chains East of corner fixed Stake & Stone 16.8.8 & bats
 Black Ash 8 S 19 W 34 1/2 Elm 20 N 69 W 103 1/2
 - F 1/4 Post & Stone 14.12.8 White Oak 20 N 81 1/2 E 79 1/2
 - G Stake bats and Stone 12.10.6 Red Oak 8 N 5 E 39 W Oak 15 S 25 1/2 W 37 1/2
 - H Stake bats and Stone 16.12.10 White Oak 8 S 40 1/2 E 26 White Oak 6 N 39 1/2 W 43
 White Oak 6 S 23 W 65
 - I S.E. Stone 22.18.12 White Oak 5 S 30 W 22 White Oak 3 N 8 E W 13 1/2 in sur Sec 32 Sept 20 11
- The above is correct to the best of my belief
 April 22nd 1871 M Schuyler Co Surveyor
 Comy.

The above notes were copied by me from note Book 16 Page 53 and 57
 and are correct to the best of my knowledge and belief
 Marcus Schuyler ex Coroner

Center BK 2

SURVEY No. In Town 5 S of Range 3 East. Plat and Notes of Survey made by me on the 26th day of Jan^y, A. D. 1889, in Sec. 3, Town 5 S, of Range 3, at the instance of Chas Stolow

- Center Top -

CONDITION OF ORIGINAL CORNERS...

CONDITION OF ORIGINAL CORNERS...

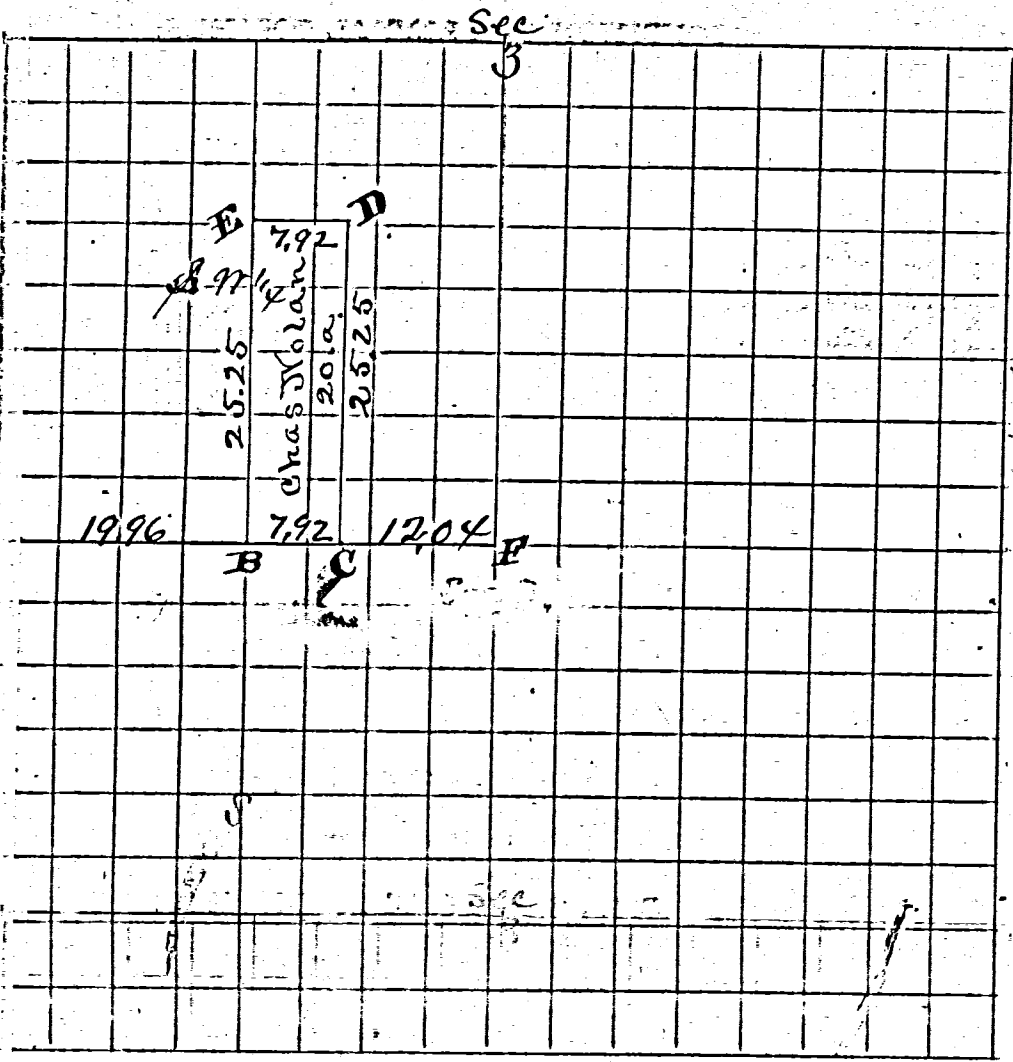

CORNERS DESCRIBED.	BEARING TREES.	D.	Course.	Dist.	BEARING TREES	D.	Course.	Dist.
A	W 1/4 Post Stone by Schuyler	Elm	N 26° W	83 1/2 lks				
B	Stone	" "	no trees					
C	stake bl ^s and stone 11x10x9. Boulder	Elm	N 3° E	33 1/4 lks				
D	" " " " 11x8x6	W Elm	N 23° W	61 "				
E	" " " " 10x9x5	no trees						
F	Stone by Schuyler at S 1/4 Post	Sweet-Cake	S 60° W	89 1/2 lks				

I certify the above survey to be correct to the best of my knowledge and belief.

J. M. Ford
Mercer Co. Ohio

SURVEY No. 3 In Town 5 of Range 3 East. Plat. and Notes of Survey made by me on the 12th & 13th days of March, A. D. 1874, in Sec. 5th 10, Town 5, of Range 3, at the instance of **Moses Townsend**

PLAT of Survey made to settle dispute as to line between sections 3 & 10 Town 5 S Range 3 E 11. Co. C. W. 1/4 P to sec. 10 S 5 R 3 E. Find old stake and positive evidence of old witness trees. Planted Stone 8 1/2 x 7 1/2 inch & stake in 0.24 S 68 1/2 W 41.

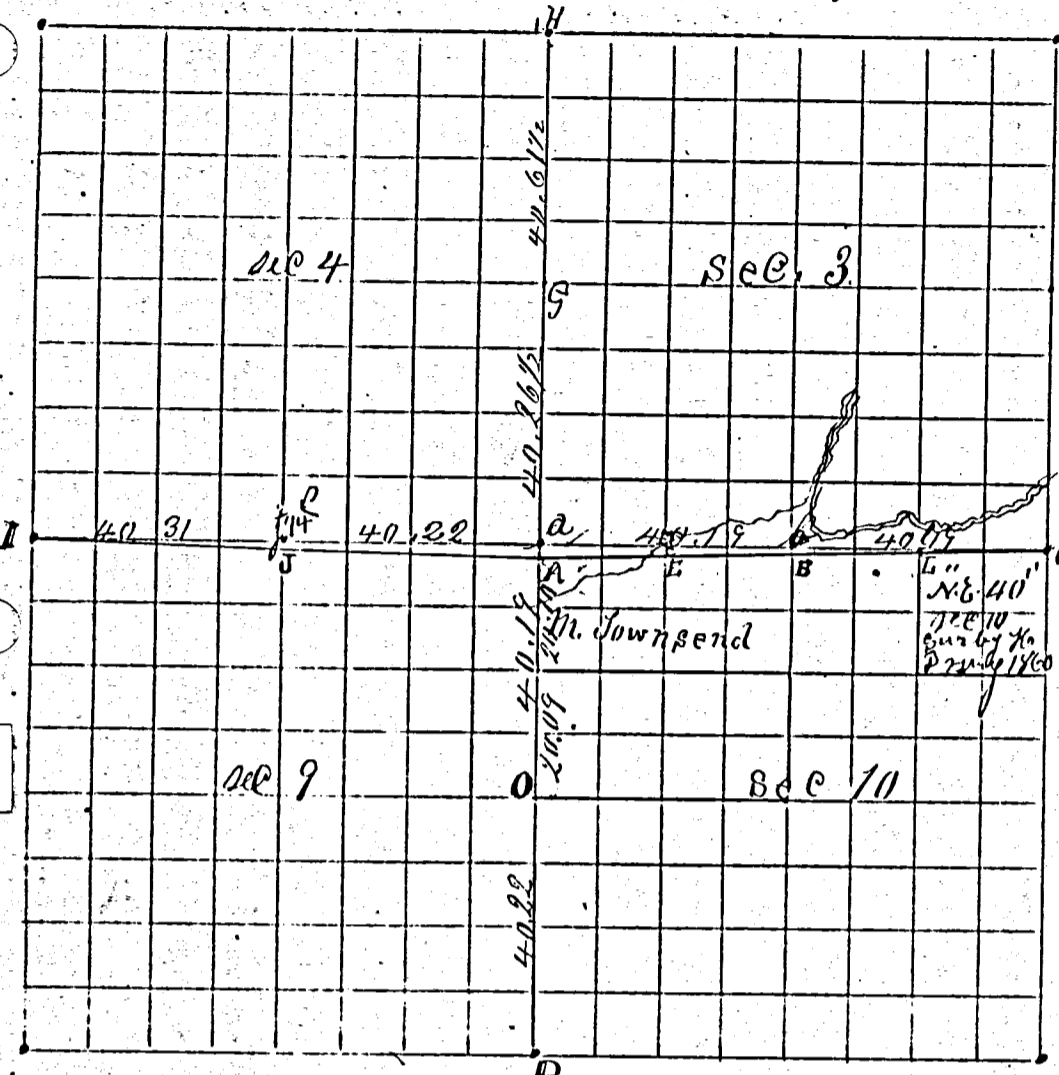

CONDITION OF ORIGINAL CORNERS.

This Survey made March 12 & 13th A. D. 1874 in sections 3 & 10, at the Instance of M. Townsend one of the land owners in said section 10 Town and Range as shown on the plat was conducted as follows: William Townsend and James Malick were agreed upon as chain carriers and sworn. A line was then run from D to A resulting in measurement as shown on the draft here exhibited. A line was then run from A to C resulting in the measurement only shown on said draft. This line shows this fact. The corners between A & C are not on a straight line. Small letter 'a' is on the straight line while 'A' is not.

CORNERS DESCRIBED.

BEARING TREES.

D.

Course.

Dist.

BEARING TREES

Dist.

Dist.

The corner to the sections above named. The distance between these two points would be 63 links: B is on a straight line from A to C. B would be 31 1/2 links north of B. A is on a straight line from A to C with 4 1/2 links. It would be 31 1/2 links north of A if A was upon the exact line from A to C. L marks a stone planted by M. Schuyler former Co. Surveyor. L marks the point where I find point of stake placed by H. Prury. L is on a straight line from A to C. L is 18 1/2 & 19 1/2 links from A. The testimony in the case is as follows.

James Malick sworn says. Albed where Snow live (see in S. H. 36) April 1857. H. Prury surveyed for me in 1860 I think. I was along. He surveyed the N. E. 40 acres of said sec. 10. How did he arrive at the position for the N. W. cor for the said 40 acres? He found it by Mr Davis' (Samuel) field notes. We started at the 1/4 Post on the East line of said sec 10 and ran north and measured that 1/2 mile to sec. corner. Then measured west but did not run by the corner posts. We measured to the 1/4 P on the north line of section 10 (above described) I do not remember anything about witness trees at said 1/4 P. Do not think we looked for any. The halfway post between the 1/4 P & sec. cor. aforesaid on the north line of sec 10 (aforesaid) had been found before we measured to the said 1/4 P. We found the witness trees and also found the iron pocket of a Jacob Doff at said cor. Ran from last said 1/4 P South to the center of the section. Found old stake and witness trees there. Then ran east to the place of beginning. We put a stake at the halfway point between the 1/4 P & sec. cor (above described) on the north line of said sec. 10. This was the first time I was ever along with any surveyor when surveying.

Samuel Davis sworn says. I came into this country in 1834. Made upon my land corner Snow live in 1835. I got Justice Hamilton to survey for me in 1835; in Sept I think. Began at the 1/4 P on the line of sec. 3 (S 5 R 3 E) I think and ran west a mile to the 1/4 P on the west line of said sec. 3. I think we then went back to within 1/4 mile of the beginning on the line we had run. Then ran south 1/2 mile to the sec. line. I think we then went west to the 1/4 P on this line between said sections 3 & 10. I think the line went on the brow of the hill (bluff of Eight mile Creek). The Pass there and I think the witness trees were. I think he found the corner with a cor at the halfway point between the S 1/4 P and S. E. cor of said sec. 3 and I think we marked witness trees. I was with him (Justice Hamilton) when he put the post at the halfway point between said S 1/4 P and the N. W. cor to said sec. 3. We marked a burr oak and placed the post a little bit north west from the tree. I think it did not exceed 2 feet from the tree.

SURVEY No. 3 In Town 5 of Range 3 East. Plat and Notes of Survey made by me on the 13th 12th day of March, A. D. 1874, in Sec. 3 & 10, Town 5, of Range 3, at the instance of Moses Townsend. Continued

This was about 1871 in May I think. A few days after this Mr. Smith Townsend, Mr. M. Townsend, Mr. Samuel Nolan and myself dug out two stakes near 3 feet apart standing N. and S. E. about 9 1/2 feet from the cor. placed by Mr. Schuyler for the 1/4 P between sections 3 & 10. I measured the dist. with an ax handle and think it was about that far. There was a hickory right tree marked on the line between the 1/4 P and S. E. cor of said sec. 3. I know the stump is still standing. The whole distance along the line was blazed out plain, and the line was never claimed or written after H. Prury surveyed the line as far north as it has been surveyed since. I think at the S. W. cor. of sec. 3 (as for said) we found everything all right, but found no stone. I think Mr. Nolan and I carried chains. Both of the old bridges were put on the sec. line as near as we could get. There was a stump in the way at each place. The east one I think was a little too far south and the west one a little too far north on account of a big burr oak stump. I think that the stone placed by Mr. Schuyler in 1871 for the 1/4 P between sections 3 & 10 as for said is very near where the old 1/4 P used to stand. It agrees with the bridges and stump referred to.

3rd Mr. Louis Shanklin. I was born 1837 and have lived on the piece of land I now live on ever since S. E. 1/4 of S. E. 1/4 of sec. 4 T. 5 R. 3 E. I think the stone is in the corner to sections 3, 4, 9 & 10 was before the stone was put there. I don't know of its ever having been moved.

4th Moses Townsend sworn says I have lived where I now live N. 1/2 of N. W. 1/4 of sec. 10 T. 5 R. 3 E. since the summer of 1850. James Crow surveyed for me in the same summer. He was County Surveyor then. We started at the cor. to sections 3, 4, 9 & 10 and ran east to the 1/4 P down & range for said. We found one beech tree which

CORNERS DESCRIBED	BEARING TREES	D.	Course.	Dist.	BEARING TREES	D.	Course.	Dist.
the said was a witness tree. He took the bearing and distance from this tree and drove a stake of wood. Did not search in particular for any other tree as there was no other tree standing near to the best of my recollection. From there we went across the section clear up to 1/4 P on S. side of sec. 10 for said. We came out very near to the corner on the South of said sec. 10. We found one witness. I think we found it to be a white ash. We then went to the 1/4 P on the west of section 10 as for said and ran east through said sec. 10 as we had fixed the center of the sec. about 9 rods South of where Hamilton had placed it - and this was to see if we were right. Mr. Crow was satisfied that he was right. He then proceeded to divide the N. W. 1/4 of the sec. I never examined the matter till 1871 when Mr. Schuyler surveyed between said sections 3 & 10 which survey did not correspond with that made by said James Crow. A few days after Mr. Schuyler had surveyed, I with Mr. Smith Townsend, Mr. Samuel Davis, and Mr. S. Nolan found the stake planted by Crow in 1850 by running a line from the S. E. cor. of sec. 3 as for said over the stake planted by H. Prury, at the N. W. cor. of the N. E. 1/4 of the N. E. 1/4 of said sec. 10. This stake I think was about 1/2 mile from the corner stone planted by Mr. Schuyler as the 1/4 P between said sections 3 & 10 a little east of north I think. I did not measure it. We also found another stake about 3 links from this stake and a little in of W. We were satisfied that it was walnut. We marked the place of the red elm stake with a solid oak stake well driven in. We went afterwards to look for said oak stake on Friday May the 10 th 1873, but could not find it. I am satisfied that it was taken up between the time of putting it there in 1871 and the time of looking for it in 1873. At the 30 rod stake between the 1/4 P of said sections 3 & 10 and the S. W. cor. of said sec. 3 we found stake in about 1857 or 1858. This was right opposite the mark on the burr oak stump said to have been marked by Hamilton in 1835. It was about 8 ft as near as I can recollect from said stump to said stake. The stake was not so rotten but what it held its shape.								

5th James Nolan sworn says The bridge east of the 1/4 P between said sections 3 & 10 was always supposed to be on the line between said sections 3 & 10. Said bridge is about 15 rods east of said 1/4 P. This bridge is about on the line run by Mr. Schuyler in 1871 - straight line from sec. cor. to sec. cor.

6th Levi Kiser sworn says I know that both of the old bridges on the road running on the N. of said sec. 10 are north of the old line. I know because I was there when the line was run by Mr. Hamilton and know of one right tree a hickory - the stump is there yet - I saw it this morning. It corresponds with a straight line from sec. cor. to sec. cor. as run by Mr. Schuyler between said sections. I know of another right tree. It was a burr oak and stood near the bridge east of the school house that stands on said sec. 10 (said school house stands near the 1/4 P between said sections 3 & 10)

Book 2



SURVEY No. 3 In Town **5** of Range **3** East. Plat and Notes of Survey made by me on the 12th & 13th day of March, A. D. 1874, in Sec. 3 & 10, Town 2, of Range 3, at the instance of Moses Townsend Continuation. The stump is standing yet. This corresponds with the line run by Mr. Schuyler in 1871.

7th Smith Townsend sworn April 5th 1875. says The corners between sections 3 & 10 (as above described) in the 1/4th moved without my knowledge in 1871. Mr. Nolan, Mr. Samuel Davis, Mr. Moses Townsend and myself were afterward and dug up an old stake which by the best means we had for ascertaining was 20 ft from said Nolan's old fence corner to the best of my knowledge the stake was a red elm stake. There was no other stake found there that day. This stake was near 18 ft north and a little east from the stone planted by Mr. Schuyler for the corner 1/4 of Sec. 3 & 10.

8th The State of Ohio Mercer County, S.S. Before me, Wm. Brubaker, J.P. in and for said County personally appeared Samuel Nolan and after being duly sworn deposeth and saith that - I bought the land that I now live on being two (2) parts of section three (3) the west half of (the) 1/4 section East quarter and the East half of the South west quarter bought this land in 1835 and I have lived within (4-1) forty rods of the 1/4 P. quarter just between sections 10 & 3 ever since and to the best of my knowledge the place where Judge Hamilton put the post is exactly where Mr. Schuyler established the post in 1871. I have traced this line a great many times and I know that it runs nearly or quite on top of the hill south of the big elm where it is banked up east of the school house. I know that there is a big hickory stump that was a right tree in the original survey and that - Schuyler's survey corresponds with the original survey. I also know that the old bridge east of a said Hick stump is right on the old section line. I know this was always acknowledged to be the true section line until Isaac Drury made the survey I think in 1860, and that said Drury in commencing his survey started 8 or 10 feet north of the original 1/4 post, and also near the end of James Nolan's lane at the big oak stump. The Cor that Mr. Schuyler made is within a very few inches of the corner that Judge Hamilton made and further this deponent saith not -

CORNERS DESCRIBED.	BEARING TREES.	D.	Course.	Dist.	BEARING TREES.	D.	Course.	Dist.
--------------------	----------------	----	---------	-------	----------------	----	---------	-------

Sworn to and subscribed before me this 7th day of March A. D. 1874. Wm. Brubaker, J.P. in and for said County personally appeared G.P. Spicer and after being duly sworn deposeth and saith that in the year 1858 as near as I can recollect - James Malick and myself put in a bridge between the hills of Davis. The center of said bridge as near as I can recollect by a right tree on the bank near said bridge did not exceed three feet from the original survey. Mr. Schuyler's survey in 1871 corresponds with the original survey where it crosses this bridge according to its marks and further this deponent saith not. G.P. Spicer

Sworn to and subscribed before me this 9th day of March 1874 Wm. Brubaker, J.P. All of the witnesses in this survey between sections 3 & 10 S 5 S R 3 E were sworn before me and their exact language taken down and copied into these records as above except the last two sworn by Justice Brubaker. O. F. Kuntzbaugh County Surveyor revealed Iowa March 3rd 1874. Mrs. Randabaugh and Armstrong Gents Gentry of the 12th is before me and contents noted and in answer would say that it has been so long since I don't remember distinctly about the corners. You say that Mr. Townsend says that one of the witness trees was standing when I set the corner. If so I can say without any hesitation that the corner I set was correct. I cannot find any of my old field notes but if you will send me a correct plat of S 5 S of R 3 E with the roads marked thereon and the exact location of Neptune and all that would be calculated. Call to mind the matters I will then try to give you the necessary information. Mark on each of these sections or parts of sections the name of the then owner & c.

James Gentry & James Crow
 March 9th 1874 Mrs. Frank E. Randabaugh. There seems to be a misunderstanding about the

SURVEY No. 8 In Town 5 of Range 3 East. Plat and Notes of Survey made by me on the day of March, A. D. 1875, in Sec. 3+10, Town 5, of Range 3, at the instance of

Townsend Continuation in 1835 the first of my clearing ~~about~~ about the quarter post. In cutting a fence row and clearing a little field joining the quarter post and in clearing the said witness trees was cut down. They had been cut down near thirty eight years and there has not been a sign of them about twenty five years. And I will be willing to it if necessary Samuel Clark Ohio

CONDITION OF ORIGINAL CORNERS.

I certify that the above is a true copy of all the evidence furnished me in the Survey as above described in sections 3+10, of Randolph Co. S. W. of the above Survey was made for the purpose of determining whether the corner at A as it is found should be removed North to a B to C as shown on the draft. Upon the measurement being made it was agreed upon all hands that the original was where the stone is now found at A. Hence any comment upon that is unnecessary, there being no evidence to the contrary. As to removing B to point b and therefore C to C and E to e at the time of making this survey no evidence whatever of witness trees could be found at or near B the 1/4 P. dispute. The presumption is that the line from the sec. cor. at A to the sec. cor. at C is a straight line. The contrary must be shown by positive evidence. That is, to establish a cor. for the 1/4 P. at b. Either witness trees shown testimony found undisputed and certain that there can be no mistake about it. I have tried to do so now more than a year and have made every possible effort to gain all the existing evidence. Hamilton, Crow nor Drury have left anything on record whereby to ascertain the manner and correctness of their surveys. I find one stake with the remains of a witness as fixed by Drury. This stake is N 82 E 1 3/4 miles from the stone set by Chrysler (P. Sur) at C. There is nothing on Drury's draft or in any of the evidence to show that this stake was

CORNERS DESCRIBED.	BEARING TREES.	D.	Course.	Dist.	BEARING TREES.	D.	Course.	Dist.
<p>placed upon a direct line from the 1/4 P. to the sec. cor. No steps were taken to perpetuate the testimony at the 1/4 B in any of these surveys, except that when James Crow surveyed a red stake was driven into the ground. He left nothing to show that this stake was placed in bearing and distance found on the original field notes, nor even left any thing by which said stake might be found. It seems that a red elm stake was found and that another stake was placed in its place to perpetuate its position in 1871. but even this is not to be found and there is quite a difference of evidence as to where it was. I have no doubt it is north of the stone placed by Chrysler in 1871 on a line between the section corners at B, but there is nothing now to show its exact position, or to show that it was placed correctly in the first place. witness says he cut down all the trees near this corner many years before said Crow had surveyed. Another says that Crow found a tree which he (Crow) said was a witness tree now says in his letter that he remembers nothing about it and can find no field notes. The discrepancies occurring throughout the whole of this testimony is only evidence of the imperfection of human recollection as to the position of land corners. The County Surveyor before me (M. S. Chrysler) fixed the corners between C upon a straight line from A to C in 1871. I can get no such evidence as would justify me in making a change. It is therefore considered by me that the corners at B and C are in their proper places.</p>								

I certify the above to be correct - 8 day of 1875

J. S. Randabaugh County Surveyor of Mercer County Ohio

Recd of Misses Co. Corners the sum
of One Hundred and Fifty seven
Dollars in full of land taken fence
moved and all damage done
in making fill on Pike from Sta 480
to Sta 498 of Center and Union Road
Improv't and I hereby agree to make
a deed to the Corners whenever
it is presented to me for the ten
feet on each side of the road
and also for 60 feet wide of ground
leading west from Pike at the South
end of my line and running to River Road
And I hereby release all claims for
Damages done in construction of Pike
David Fireweed