

BRICKER SURVEY
PART NW 1/4, SEC. 26, T55, R1E, LIBERTY TWP.
MERCER CO., OHIO

LOCATION PLAT

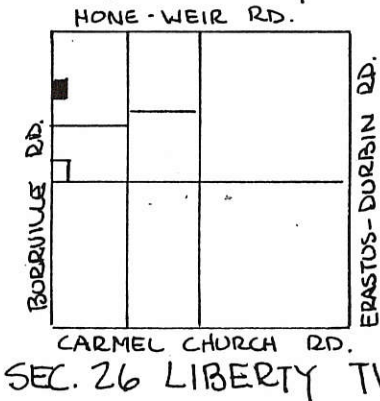

SCALE: 1" = 50'

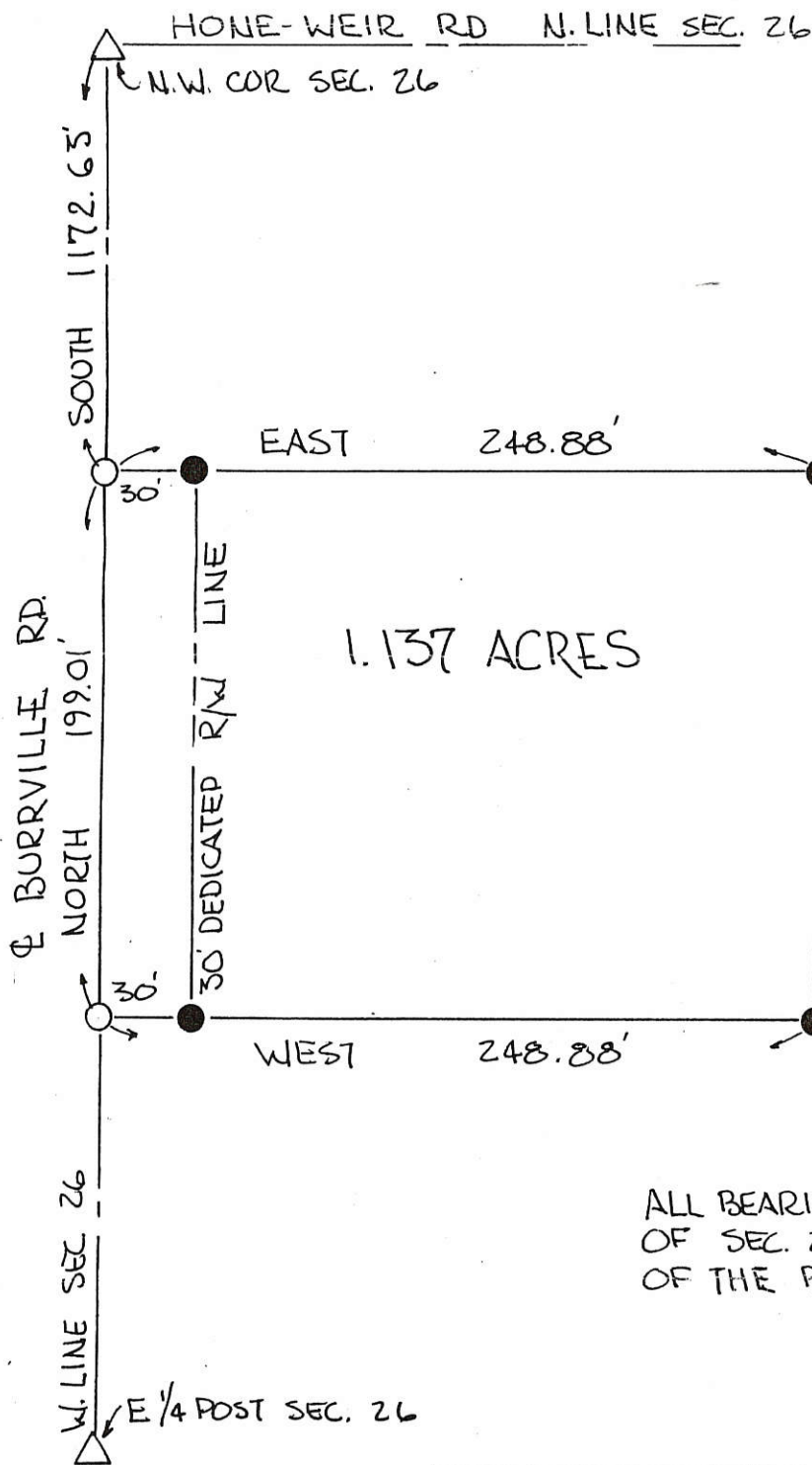

LEGEND:

- △ STONE REF.
- SPIKE SET
- 3/4" φ I. PIN SET

PARCEL NOT IN FLOOD HAZARD ZONE - "FIRM" PANEL# 390392-0075 B SEPT. 1989-

GRANTOR DEDICATES ADDITIONAL LAND EAST OF AND ADJACENT TO THE EXISTING RIGHT-OF-WAY OF THE BURRVILLE ROAD TO CREATE A THIRTY (30.00) FOOT RIGHT OF WAY ALONG THIS PARCEL-

~~VELONE L.B. BRICKER, GRANTOR, DATE~~

Stanley Bricker 6-23-90

STANLEY BRICKER, GRANTOR

Velone Bricker 6-23-90

VELONE BRICKER, GRANTOR

ALL BEARINGS TURNED FROM THE WEST LINE OF SEC. 26, ALSO BEING THE CENTERLINE OF THE BURRVILLE RD - ASSUMED NORTH-SOUTH

PLAT BY SURVEY JUNE 1990
Roy F. Thompson Jr.
ROY F. THOMPSON JR. REG. 502# 5379

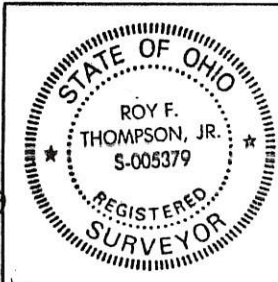

PERMANENT PARCEL No.	_____
Part of: NW 1/4 Sec. 26 T55 R 1E LIBERTY Township	
Grantor: BRICKER Area Retained: _____ Acres	
Grantee: _____ Area Transferred: 1.137 Acres	
Deed References: V237 P490 V287 P658	
APPROVALS:	<i>Boyd W. Gendler</i> 6/19/90 <i>Velone Bricker</i> 6/19/90
AGENCY: Board of Health Co. Sanitary Engineer County Engineer	
DATE: 19 JUN, 1990	

Orig. Signatures!

BRICKER SURVEY
PART NW 1/4 SEC 26, T55, R1E, LIBERTY TWP.
MERCER CO., OHIO

04-26-100-003



SCALE 1" = 100'
0 25 50 100

LOCATION PLAT

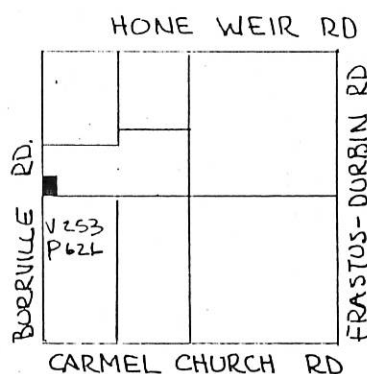

SEC 26, T55, R1E
LIBERTY TWP.

STONE - N.W. COR. SEC 26

BURRVILLE RD.

EAST LINE SEC 26 NORTH 538.67'

N 89° 30' 15" E
165.00'

LINE

2.039 AC.

RIGHT-OF-WAY

SOUTH 538.06'

S 89° 11' 35" W
165.00'

1/2 SECTION LINE

STONE
E 1/4 POST SEC. 26

LEGEND

- △ STONE REF.
- 3/4" IRON PIN SET
- RR SPIKE SET

PARCEL NOT IN FLOOD HAZARD ZONE
"FIRM" MAP PANEL NO. 390392 0075 B SEPT 1989

THE GRANTOR DEDICATES ADDITIONAL LAND EAST OF AND ADJACENT TO THE EXISTING RIGHT-OF-WAY OF THE BURRVILLE ROAD TO CREATE A THIRTY (30.00) FOOT RIGHT OF WAY ALONG THIS PARCEL -

Velone L. B. Bricker Dec. 12th 1989
VELONE L.B. BRICKER, GRANTOR DATE

EXISTING CORNER POST
CENTER SEC. 26

ALL BEARING TURNED FROM THE WEST LINE OF SEC 26, ALSO BEING THE CENTERLINE OF THE BURRVILLE RD - ASSUMED NORTH-SOUTH.

PLAT BY SURVEY DEC 1989

Roy F. Thompson Jr.
ROY F. THOMPSON JR. SURV 5379



PERMANENT PARCEL No. _____	
Part of: NW 1/4 Sec. 26 T55 R1E LIBERTY Township	
Grantor: BRICKER	Area Retained: _____ Acres
Grantee: _____	Area Transferred: 2.039 Acres
Deed References: V231 P450 & V287 P658	
APPROVALS:	<u>John F. Gilligan</u> County Engineer
AGENCY: Board of Health	Co. Sanitary Engineer
DATE: 12/8/89	12-8-89

FILED IN SURVEY BOOK

Co. Eng. 04-5
04-26-200-002

HONE SURVEY
PART NE 1/4, SEC. 26, T5S, R1E, LIBERTY TWP.
MERCER CO., OHIO

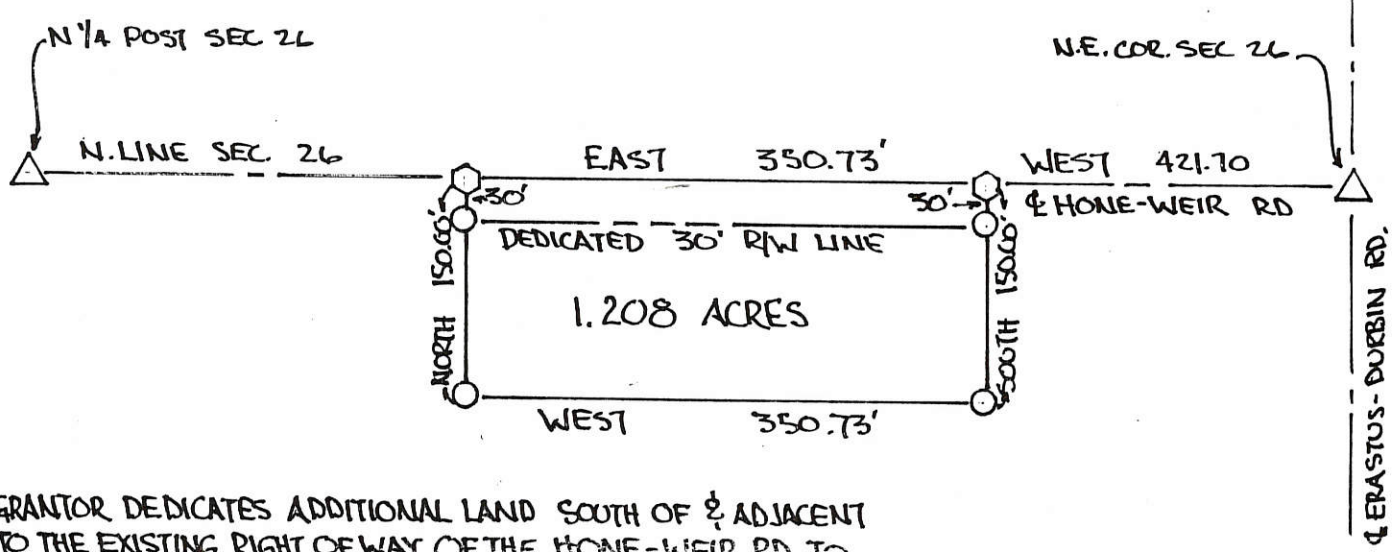
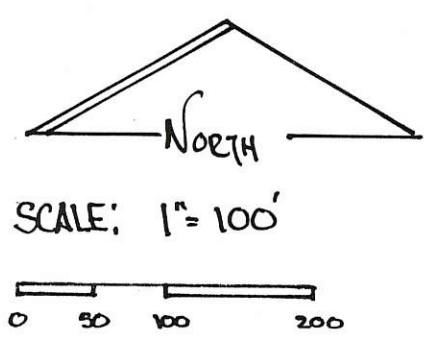
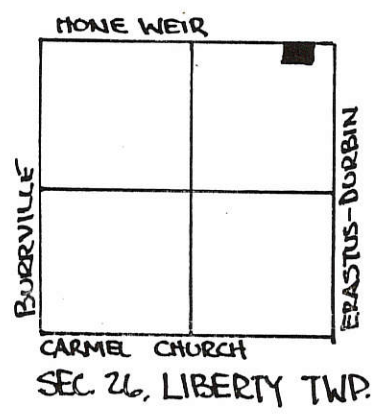

GRANTOR DEDICATES ADDITIONAL LAND SOUTH OF & ADJACENT TO THE EXISTING RIGHT OF WAY OF THE HONE-WEIR RD TO CREATE A THIRTY (30.00) FOOT RIGHT OF WAY ALONG THIS PARCEL.

Velma Hone 11/19/90
VELMA HONE, GRANTOR DATE

LEGEND-

- R.R. SPIKE SET
- IRON PIN SET
- △ SEC. COR. FOUND

PARCEL NOT IN FLOOD HAZARD ZONE -
"FIRM" PANEL # 390392-0075 B
SEPT. 1989-

ALL BEARINGS TURNED FROM NORTH LINE SEC. 26 & HONE-WEIR RD ASSUMED EAST-WEST

PLAT BY SURVEY NOV. 1990
Roy F. Thompson, Jr.
ROY F. THOMPSON JR REG SUR 5379



PERMANENT PARCEL No. _____		
Part of: <u>NE 1/4</u> Sec. <u>26</u> T <u>5S</u> R <u>1E</u> <u>LIBERTY</u> Township		
Grantor: <u>HONE</u>	Area Retained: <u>38.792</u> Acres	
Grantee: _____	Area Transferred: <u>1.208</u> Acres	
Deed References: _____		
APPROVALS: <u>Board of Health</u>	Co. Sanitary Engineer	<u>Michael Baus</u> County Engineer
DATE: <u>15 Nov 1990</u>		<u>11/15/90</u>

Original Signatures

0426300005

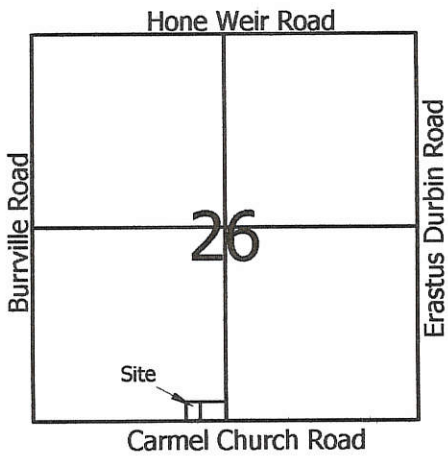

Legend:

- Cornerstone @ the S1/4 Post of Section 26
- Cornerstone @ the SW corner of Section 26
- 5/8" X 30" Iron Pin w/cap set on line and 20.00 feet from corner
- 5/8" X 30" Iron Pin w/cap set
- Mag nail set

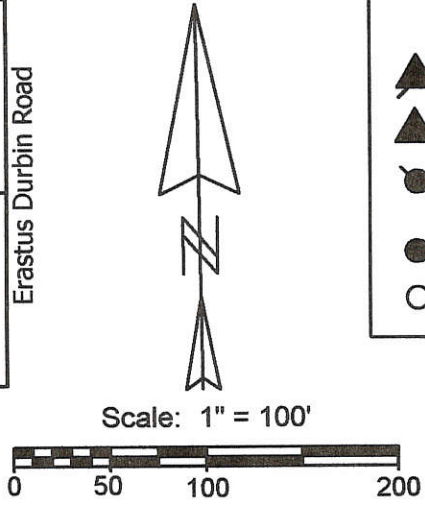

Donald & Mary Jane Stachler
O.R.144, Pg.2003

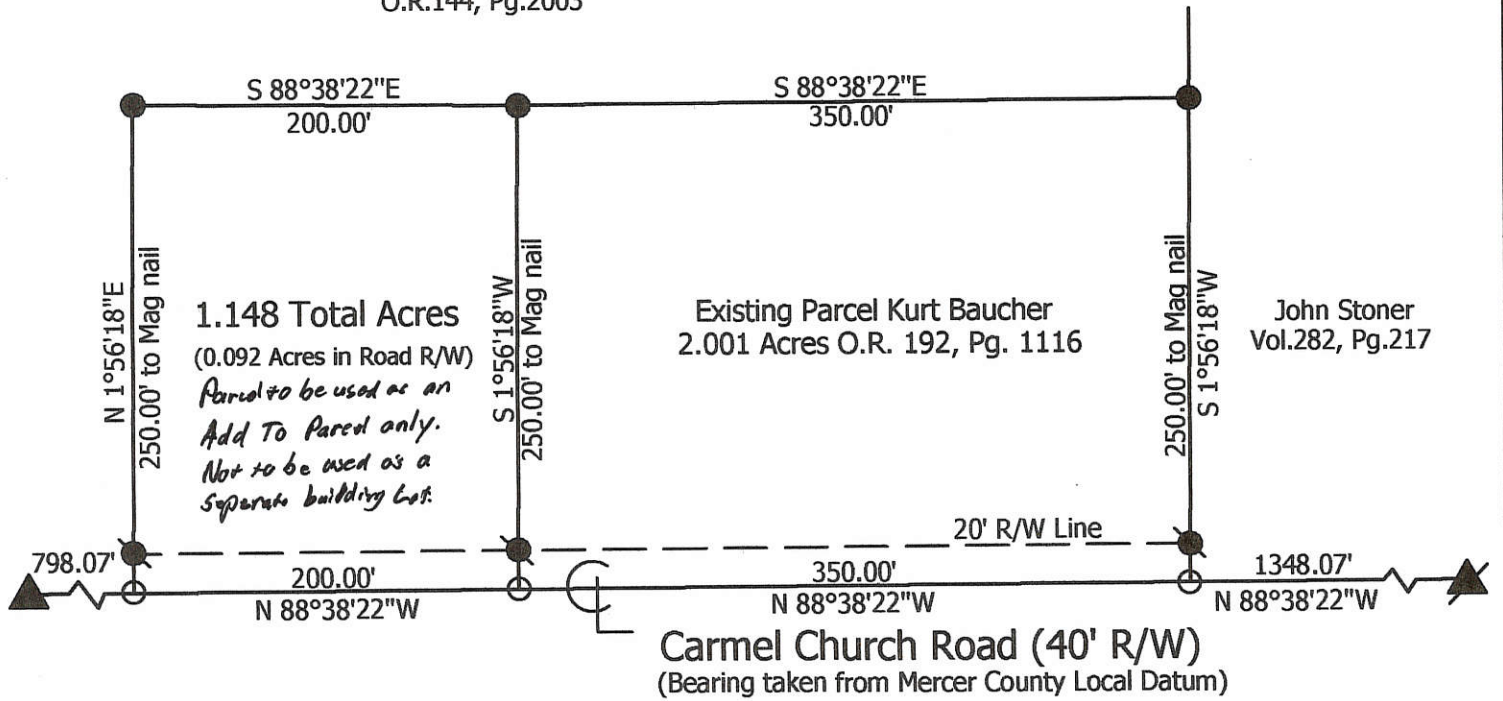

**Marbaugh
Land Surveying**

1901 Carolina Court
Celina, Ohio 45822
(419) 586-4293

Kent Marbaugh
Kent B. Marbaugh P.S.7421



Stachler to Baucher Survey

State of: Ohio County: Mercer
 Township: Liberty Sec: 26 Town: 5S Range: 1E
 City/Village: _____ Subdivision: _____ Lot: _____
 Deed Ref: O.R.144, Pg.2003 Date Surveyed: 5-16-08

Approvals:	_____	_____	_____
Agency:	Board of Health	Township Zoning Inspector	County Engineer
Date:	_____	_____	_____

04-J(26)

04-26-300-005 ✓

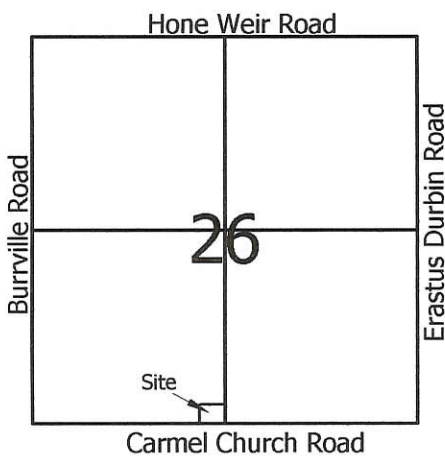

- Legend:**
- ▲ Cornerstone @ the S1/4 Post of Section 26
 - ▲ Cornerstone @ the SW corner of Section 26
 - 5/8" X 30" Iron Pin w/cap set on line and 20.00 feet from corner
 - 5/8" X 30" Iron Pin w/cap set
 - Mag nail set

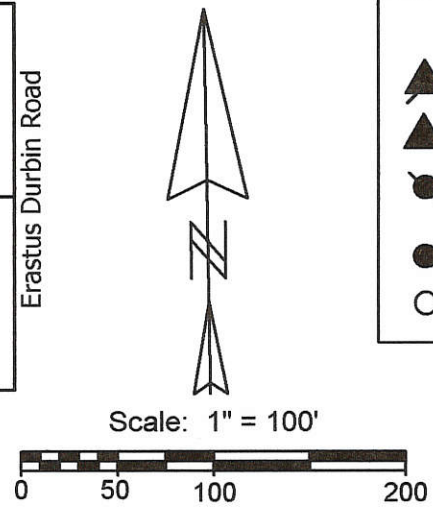

Note: Cornerstones @ the East, West & North 1/4 posts of Section 26 were also used to determine the east line of this parcel.

Donald & Mary Jane Stachler
O.R.144, Pg.2003

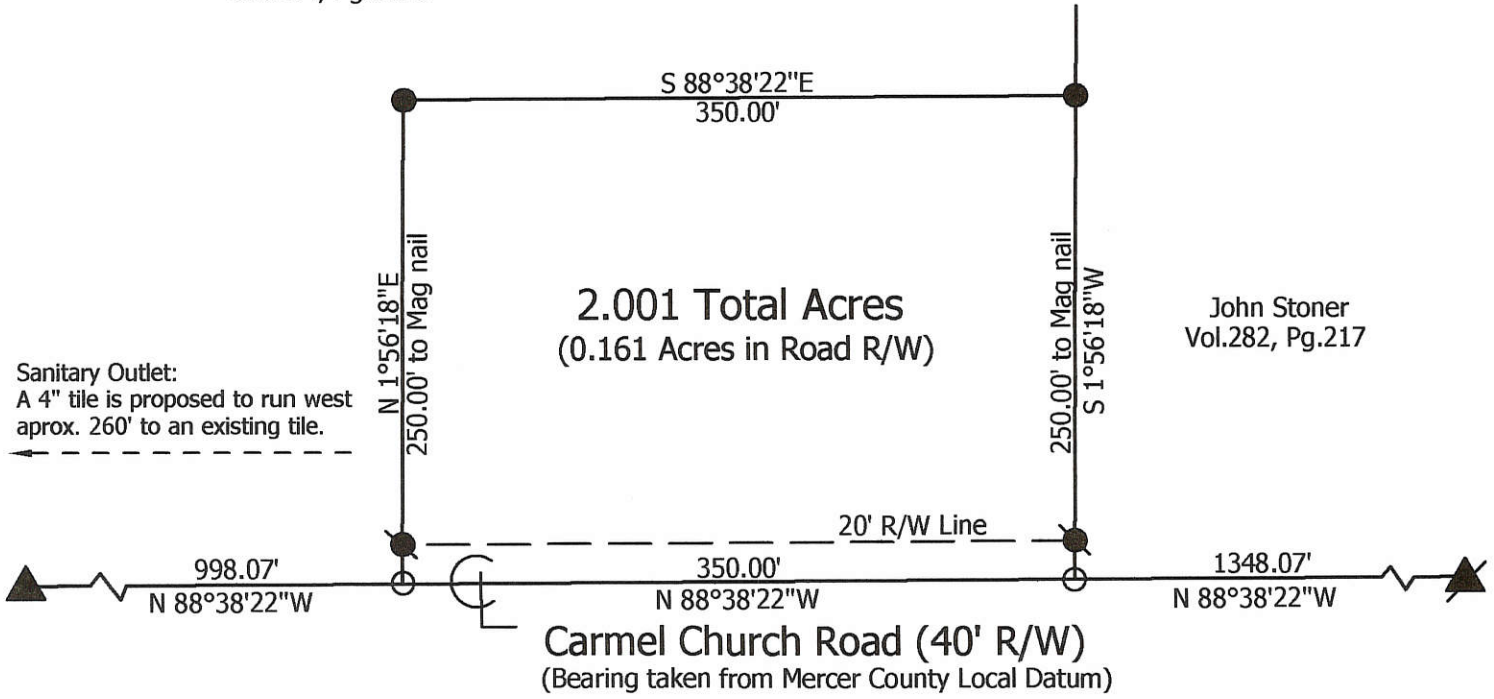

**Marbaugh
Land Surveying**

1210 Yorkshire Court
Celina, Ohio 45822
(419) 586-4293



Donald & Mary Jane Stachler Survey

State of: Ohio County: Mercer
 Township: Liberty Sec: 26 Town: 5S Range: 1E
 City/Village: _____ Subdivision: _____ Lot: _____
 Deed Ref: O.R.144, Pg.2003 Date Surveyed: 10-29-04

Approvals: _____
 Agency: Board of Health Township Zoning Inspector County Engineer
 Date: _____

Kent Marbaugh
 Kent B. Marbaugh P.S.7421

0426300006

Burrville Road (40' R/W)



Legend:

- Cornerstone @ the W1/4 Post of Section 26
- Cornerstone @ the SW corner of Section 26
- 5/8" X 30" Iron Pin w/cap set on line and 20.00 feet from corner
- 5/8" X 30" Iron Pin w/cap set
- Mag nail set

Donald & Mary Jane Stachler
O.R.144, Pg.2003

4.632 Total Acres
(0.119 Acres in Road R/W)

Donald & Mary Jane Stachler
O.R.144, Pg.2003

S 87°27'21"E
778.00' to mag nail

N 87°27'21"W
778.00' to mag nail

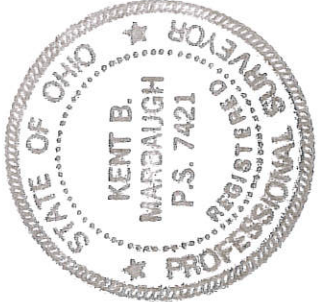
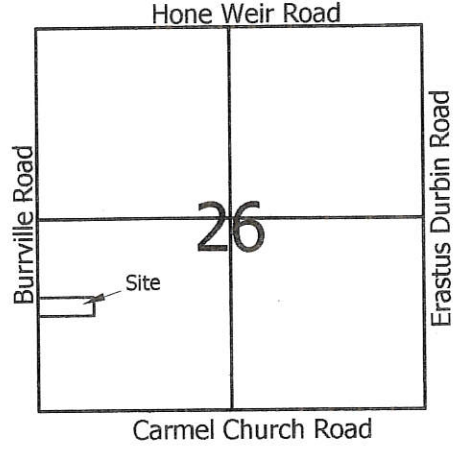
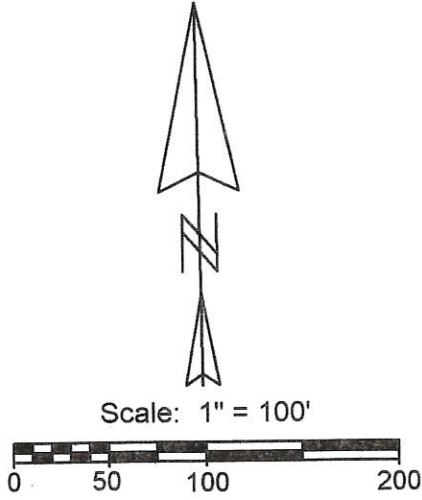
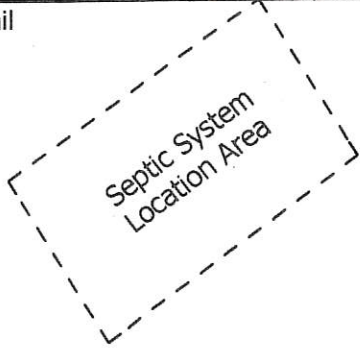

**Marbaugh
Land Surveying**
1901 Carolina Court
Celina, Ohio 45822
(419) 586-4293

Kent B. Marbaugh
Kent B. Marbaugh P.S. 7421

Stachler to Baucher Survey

State of: Ohio County: Mercer
 Township: Liberty Sec: 26 Town: 5S Range: 1E
 City/Village: _____ Subdivision: _____ Lot: _____
 Deed Ref: O.R.144, Pg.2003 Date Surveyed: 4-23-08
 Approvals: *Ch. M. Board* _____
 Agency: Board of Health Township Zoning Inspector
 Date: 5-12-08 _____
 County Engineer
5-9-08

04-J (26)

042640001

4-J ✓

LEGEND

- ⊘ = RAILROAD SPIKE FOUND.
 - ⊗ = PATENT SURVEY STAKE FOUND.
 - = MAG NAIL SET.
 - = 5/8 INCH IRON BAR SET.
 - ⊕ = CALC. PT.
- BEARINGS ARE BASED ON MERCER COUNTY GPS DATUM.

SURVEYED BY James W. Geeslin
JAMES W. GEESLIN
 P.S. No. 7764

LOCATION SKETCH

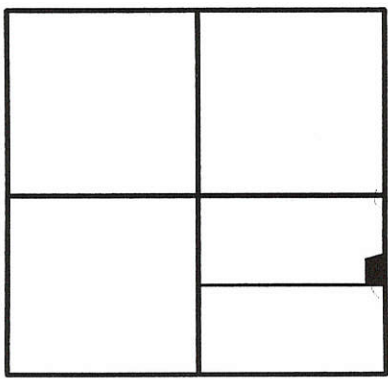

SECTION 26



N.W. COR.-
 N.1/2-S.E. 1.4-
 SEC. 26

N 88°40'29" W 2656.06'
 S. LINE - N. 1/2 - S.E. 1/4 - SEC. 26

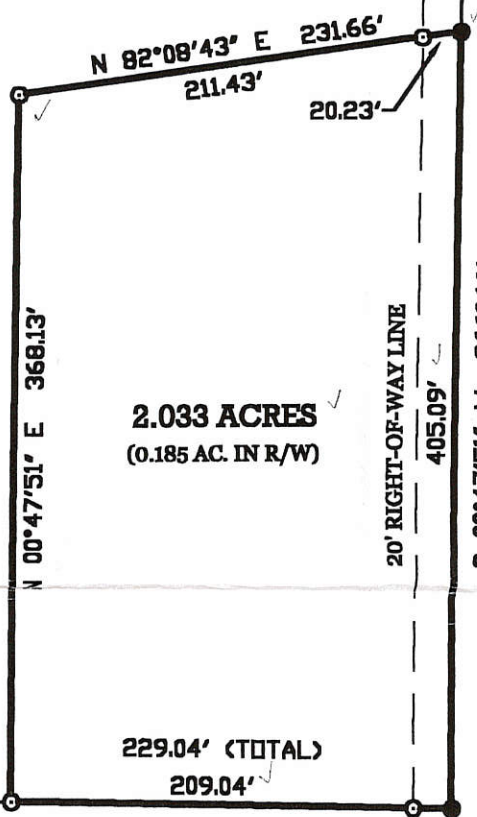

2.033 ACRES
 (0.185 AC. IN R/W)

229.04' (TOTAL)
 209.04'

N.E. COR.-
 S.E. 1/4-
 SEC. 26

924.99'

20' RIGHT-OF-WAY LINE

S 00°47'51" W 2660.16'

E. LINE - S.E. 1/4 - SEC. 26 & G. ERASTUS - DURBIN RD.

1330.08'

S.E. COR.-
 SEC. 26

STONER SURVEY

PART OF THE N. 1/2 OF THE S.E. 1/4 OF SECTION 26, T. 5 S.,
 R. 1 E., (LIBERTY TOWNSHIP), MERCER COUNTY, OHIO.

JANUARY 2, 2001

SCALE 1" = 100'



PAID

\$ 20.00 - 1 Lot
 JAN 16 2001

Carolyn Kohlman
 MERCER COUNTY COMMISSIONERS
 CELINA, OHIO

GEESLIN LAND SURVEYING

P.O. BOX 422
 804 EAST MARKET STREET
 CELINA, OHIO
 PHONE (419) 586-6155
 FAX (419) 586-1826



PERMANENT PARCEL No. _____		
Part of: _____ Sec. _____ T _____ R _____ Township		
Grantor: _____		Area Retained: _____ Acres
Grantee: _____		Area Transferred: _____ Acres
Deed References: _____		
APPROVALS:	<i>James W. Geeslin</i>	County Sanitary Engineer
AGENCY:	Board of Health	County Engineer
DATE:	16 JAN 01	<i>[Signature]</i>

-0005
-004

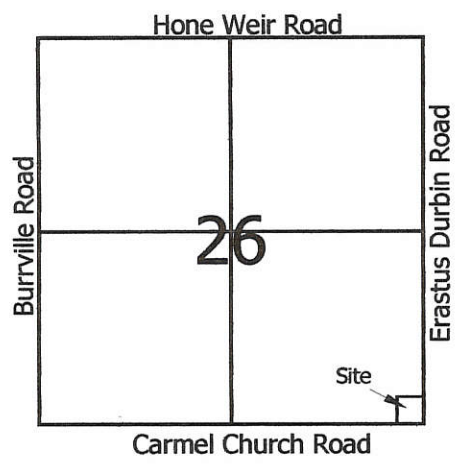

Legend:

- ▲ Cornerstone @ the S1/4 Post of Section 26
- ▲ Cornerstone @ the SE corner of Section 26
- ▲ Cornerstone @ the E1/4 Post of Section 26
- 5/8" X 30" Iron Pin w/cap set on line and 20.00 feet from corner
- 5/8" X 30" Iron Pin w/cap set
- Mag nail set

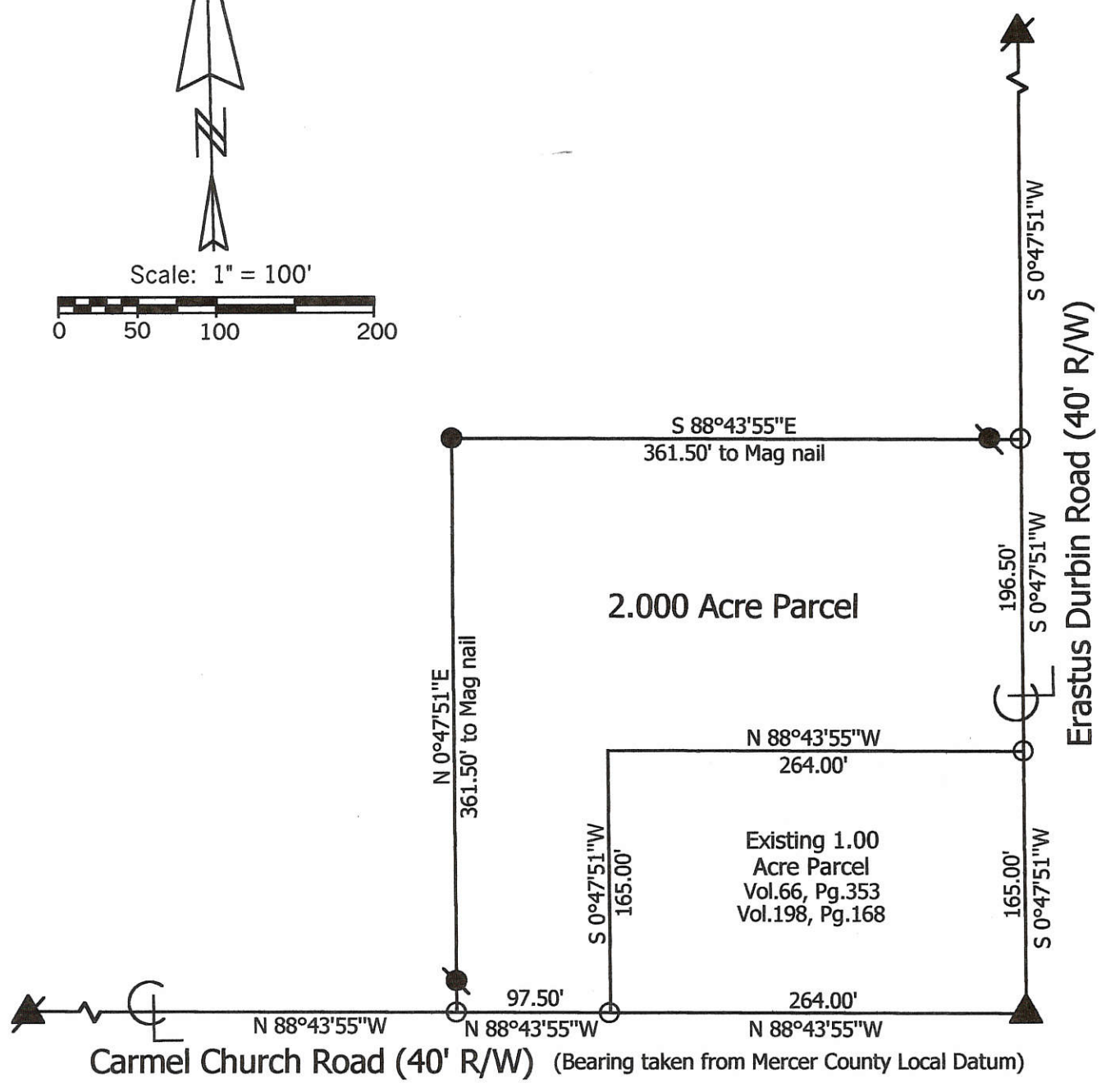
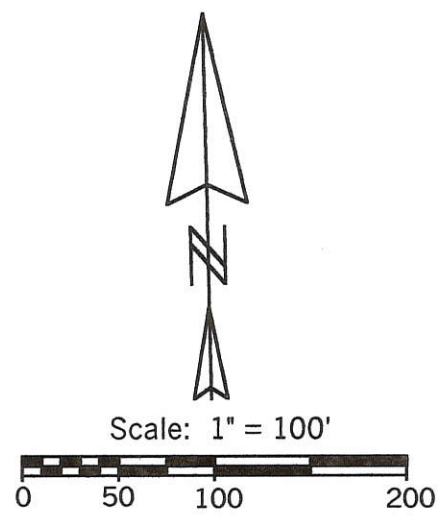

**Marbaugh
Land Surveying**
1210 Yorkshire Court
Celina, Ohio 45822
(419) 586-4293
Kent Marbaugh
Kent B. Marbaugh P.S.7421



Mount Carmel Church Survey

State of: Ohio County: Mercer
 Township: Liberty Sec: 26 Town: 5S Range: 1E
 City/Village: _____ Subdivision: _____ Lot: _____
 Deed Ref: Vol.302 Pg.847 Date Surveyed: 7-25-03

Approvals:
 Agency: Board of Health *Kent Marbaugh* Township Zoning Inspector
 Date: _____ County Engineer

BUEHLER SURVEY OUT OF CLARENCE BRICKER FARM

SE 1/4 - SW 1/4 SECT-26 T55-R1E

LIBERTY TWP. MERCER CO OHIO.

NOV-1953

C. BRICKER

P 466.2

4'

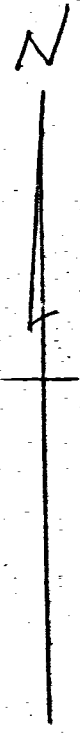

C. R. BAUGHER

N 0° 30' E
466.62

W. BUEHLER

W. BUEHLER TRACT

5 AC.

E 29.997

C. BRICKER

- △ = ORIG. SECT. STONE
- = IRON STAKE
- = WOOD STAKE
- ✕ = FENCE
- SCALE 1 INCH = 40'

STONE SW 1/4 SECT 26

SECT-26
SECT 35

END POST

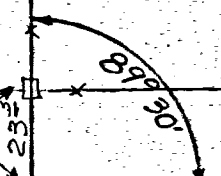

⊙ MUD PIKE? 466.62 CARMEL CHURCH

HARROW TOOTH

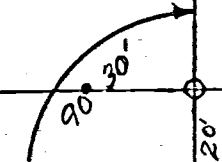

24" W. OAK

NOV-1953

B. R. Gehhart
REG. # 3909

SEC. 26 T5 S R1E LIBERTY TWP.

1877 J.R. Oliver et al, Survey Bk 3, pg 144

ROAD RECORD

Sec 26 T5 S. R1 E Liberty Township

Plat and Notes of Survey made by me on the 14. 15. 17 and 18th days of Dec 1877 in Sec 26 T5 S. R1 E at the Instance of J R Oliver & Oliver W. A Van Horn and Henry Stone Chairman sworn Henry Stone and Milton Swartz

A Stake Stone 32, 12, 8 Birch 20 N 75 E 23 Beech 16 S 46 W 115

B N Post trees lost line bisected Stake and Stone 14, 8, 6

White Oak 8 S 69 E 44 1/2 Hickory 8 S 40 W 17

C Stone by me in former Survey as trees

D 6 1/2 Post Stone W. Oak

E Stone corner found correct Stone 14, 8, 8 N 45 W 50 witness

S 1/2 Post Stake I find the stump of Elm 18 N 34 W Beech 12 S 38 E 15 also

Stake Lime Stone 2, 3, 4, 4 triangular Beech 12 S 4 W 34 Hickory 7 N 47 1/2 E 42

H S. 1/2 Stake Stone 18, 14, 8 White Oak 40 S 78 W 96

I Stone Elm 12 N 89 E 163 1/2 Stone witness West 30 links

J W 1/4 Post I find a stump of W. Ash 6 inches diameter

Burr Oak West 46 White Oak 12 N 45 E 96

K S. line Stake 20, 16, 2 no trees

L Stake Stone of Sec 26, crossing of right lines from 1/4 Post 13

M Stake Stone 18, 8, 4 Blue Ash 9 S 73 E 60 Beech 22 N 11 1/2 E 103

N Stake Stone 19, 14, 4 White Oak 22 N 68 E 115 Hickory 26 N 6 E 123 1/2

O Stake W Oak Ash 11 N 77 E 19 W Ash 8 N 85 W 36 - (2)

P Stake Stone 18, 15, 10 Hickory 6 N 81 1/2 W 44 Elm 8 S 51 W 40

Q Stake Stone 10, 6, 5 W Oak 4 S 30 E 51 1/2 White Oak 8 N 39 1/2 E 103 1/2

R Stake Stone 13, 8, 6 no trees marked

I hereby certify the above correct to the best of my belief Liberty Dec 20th 1877.

M Schuyler Co Surveyor of Mercer Co. Ohio

The above notes of survey were copied by me from estate Book no 19 Pages 227 and 228 and are correct to the best of my knowledge and belief

Witness my hand and seal at Liberty Dec 20th 1877 M Schuyler

MERCER COUNTY.

04-H
 10-E
 12-J
 04-S

Plat of Co Road #576

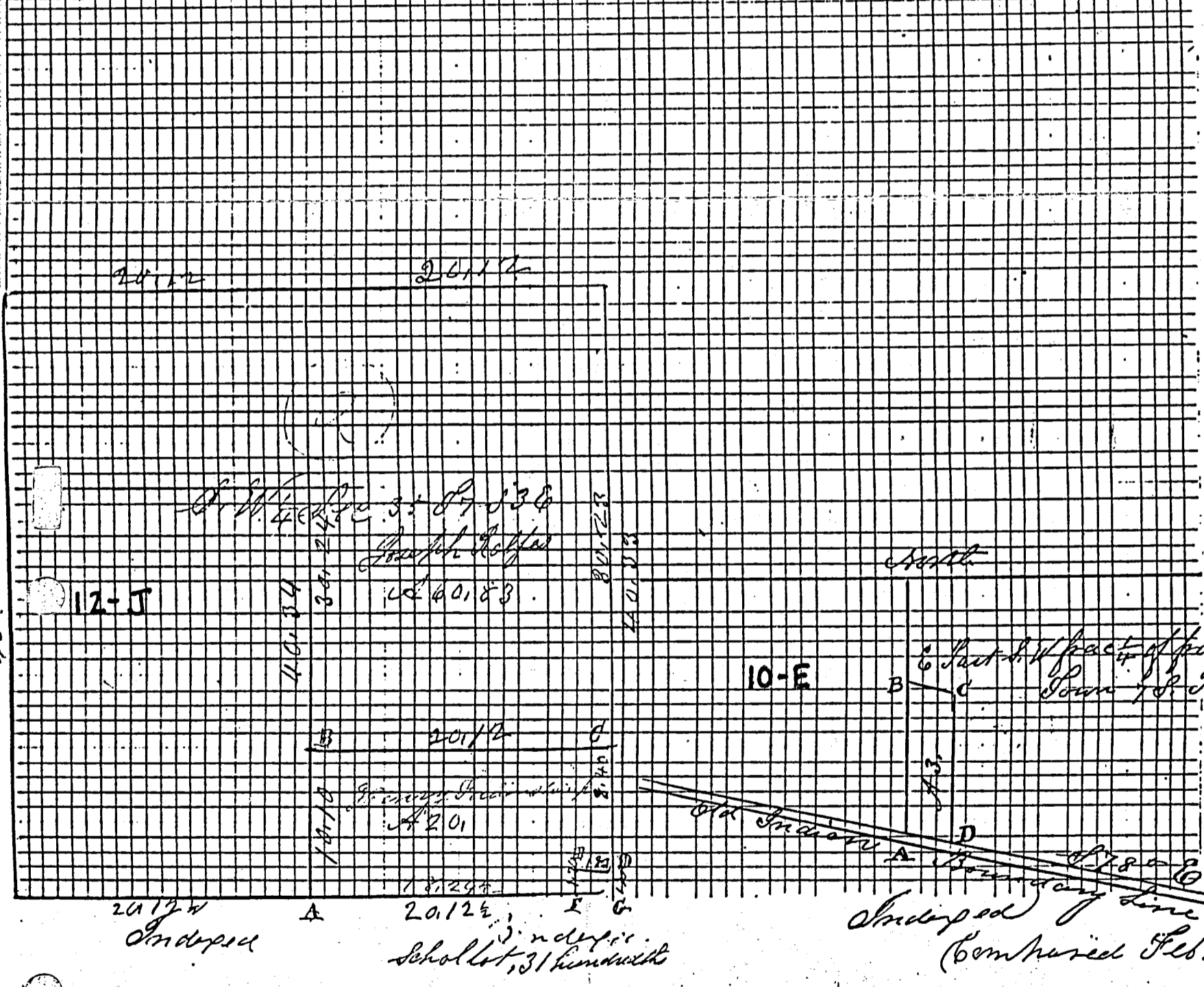
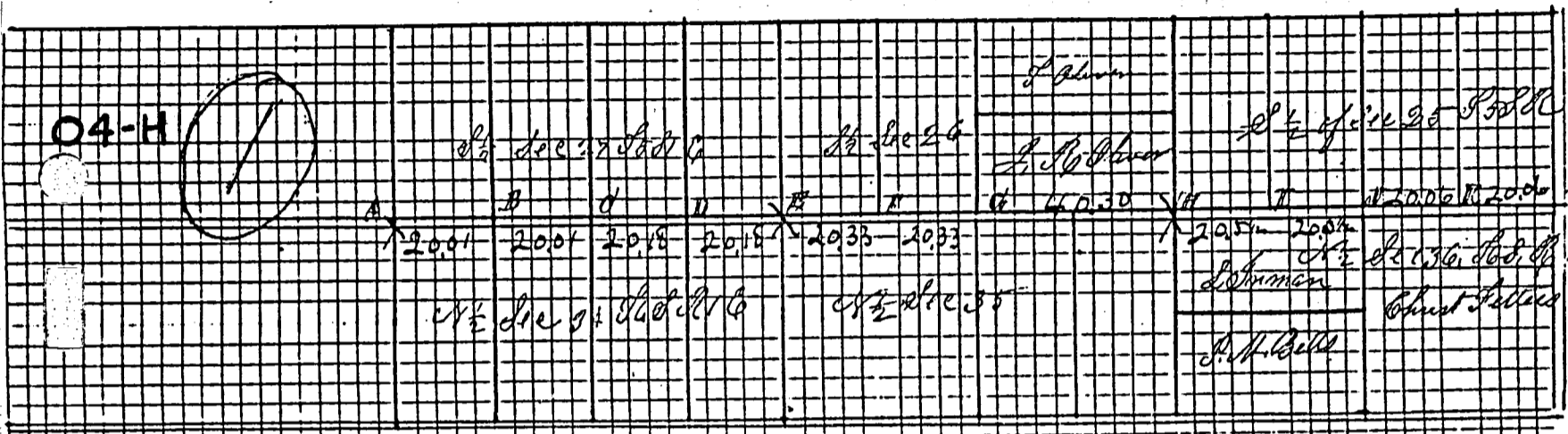

Survey made by me in the West side of E part of SW 1/4 of
 Sec 21 T. 18. N. 16. W. at East of Owners
 Stone in survey Jan 1868 Stone 18. 18. 12 Hickory 6 N 33 1/2 W 63
 S. Stone 12. 12. 9 Sweet Oak 20 N 20 W 44
 S. Stone 10. 6. 6 Sweet Oak 14 S 53 1/2 W 124
 S. Stone 15. 8. 4 Nourberry 14 North 20 not marked
 R. ... Mr. ... 1861

BUEHLER SURVEY OUT OF CLARENCE BRICKER FARM

SE 1/4 - SW 1/4 SECT. 26 T.55-R.1E

LIBERTY TWP. MERCER CO. OHIO.

NOV. 1953

C. BRICKER

466.2

4'

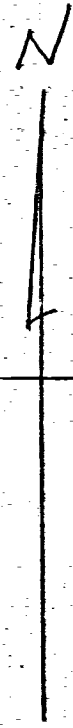

C. R. BAUGHNER

N 0° 30' E
466.62

W. BUEHLER

W. BUEHLER TRACT

5 AC.

466.62

C. BRICKER

△ = ORIG. SECT. STONE

○ = IRON STAKE

□ = WOOD STAKE

* = FENCE

SCALE 1 INCH = 40'

STONE SW 1/4 1/4 SECT 26

END POST

SECT. 26
SECT. 35

MUD PIKE? 466.62 CARMEL CHURCH

HARROW TOOTH!

24" W. OAK

NOV-1953

B. R. Gebhart
REGST. # 3909

SEC. 26 T5 S R1E LIBERTY TWP.

1877 J.R. Oliver et al, Survey Bk 3, pg 144

ROAD RECORD

Sec 26 T5 S. R1E Liberty Township

Plat and Notes of Survey made by me on the 14. 15. 17 and 18th days of Dec 1877 in Sec 26 T5 S. R1E at the Instance of J. R. Oliver & Oliver W. A. Van Horn and Henry Stone Chairman of said Henry Stone and Milton Swartz

A Stake Stone 32, 12, 8 Buck 20 N 75 E 23 Beech 16 S 46 W 115
B N¹/₄ Post trees lost line bisected stake and Stone 14, 8, 6
White Oak 8 S 69 E 44¹/₂ Hickory 8 S 40 W 17
C Stone by me in former Survey notes

D 6¹/₂ Post Stone W. Oak
E Stone corner found correct Stone 14, 8, 8 N 45 W 50 witness
S¹/₄ Post C Stake I find the stump of Elm 18 N 34 W 9 Beech 12 S 38 E 15 also

Stake line Stone 23, 4, 4 triangular Beech 12 S 4 W 34 Hickory 7 N 47¹/₂ E 42
H S. line Stone 18, 14, 8 White Oak 40 S 78 W 96
I Stone Elm 12 N 89 E 16 3/4 stone witness West 30 links

J W¹/₄ Post I find a stump of W. Ash 6 inches diameter
Burr Oak West 46 White Oak 12 N 45 E 96
K S. line Stone 20, 16, 2 no trees

L alteration of Sec 26 at crossing of right lines from 4 Posts to 3
M Stake line Stone 18, 8, 4 Blue Ash 9 S 73 E 60 Beech 22 N 17¹/₂ E 103
N Stake Stone 20, 34 White Oak 22 S 66 E 57¹/₂ Hickory 26 N 6 E 123¹/₂

O Stake W Oak Ash 11 N 77 E 19 W Ash 8 N 85 W 36 - (2)
P Stake Stone 18, 15, 10 Hickory 6 N 81¹/₂ W 44 Elm 8 S 51 W 10
Q Stake Stone 10, 6, 5 W Oak 4 S 30 E 51¹/₂ White Oak 8 N 39¹/₂ E 103¹/₂

R Stake Stone 13, 8, 6 no trees marked

I hereby certify the above correct to the best of my belief
Liberty Dec 20th 1877.

J Witness *[Signature]* M. Schuyler Co Surveyor of Mercer Co. Ohio

K The above notes of survey were copied by me from estate
Book no 19, Pages 227 and 228 and are correct
to the best of my knowledge and belief
L *[Signature]*
M Stake Stone 10, 6, 5
O *[Signature]*

MERCER COUNTY.

04-3
144

1877 J.R. Oliver et al, Survey blk 3, pg 144

~~SEC-26-T-5-S-R-1-E~~

LIBERTY TWP.

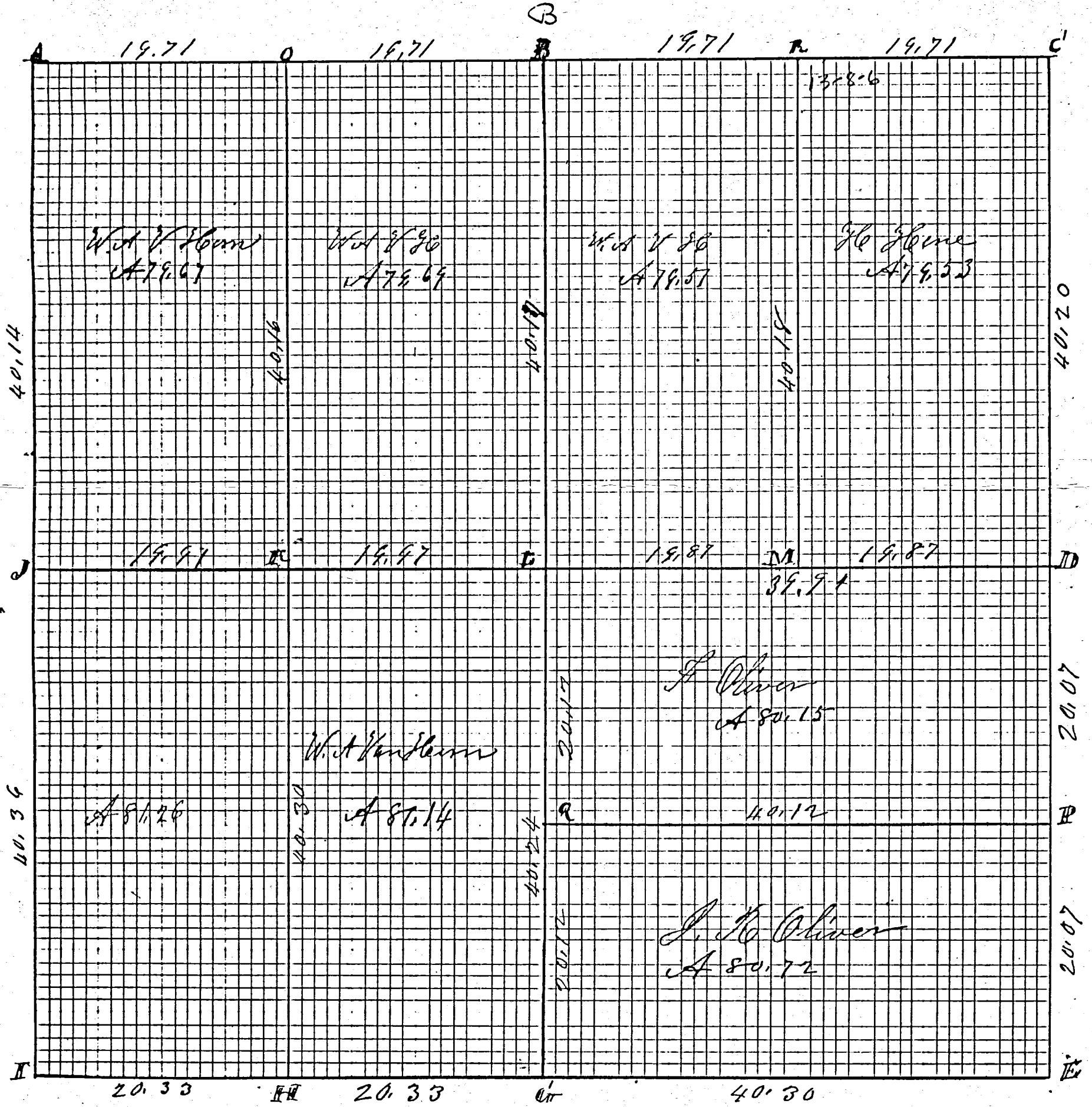

Indexed

MERCER COUNTY.

04-H
 10-E
 12-J
 04-J

Plot of Co Road N 376

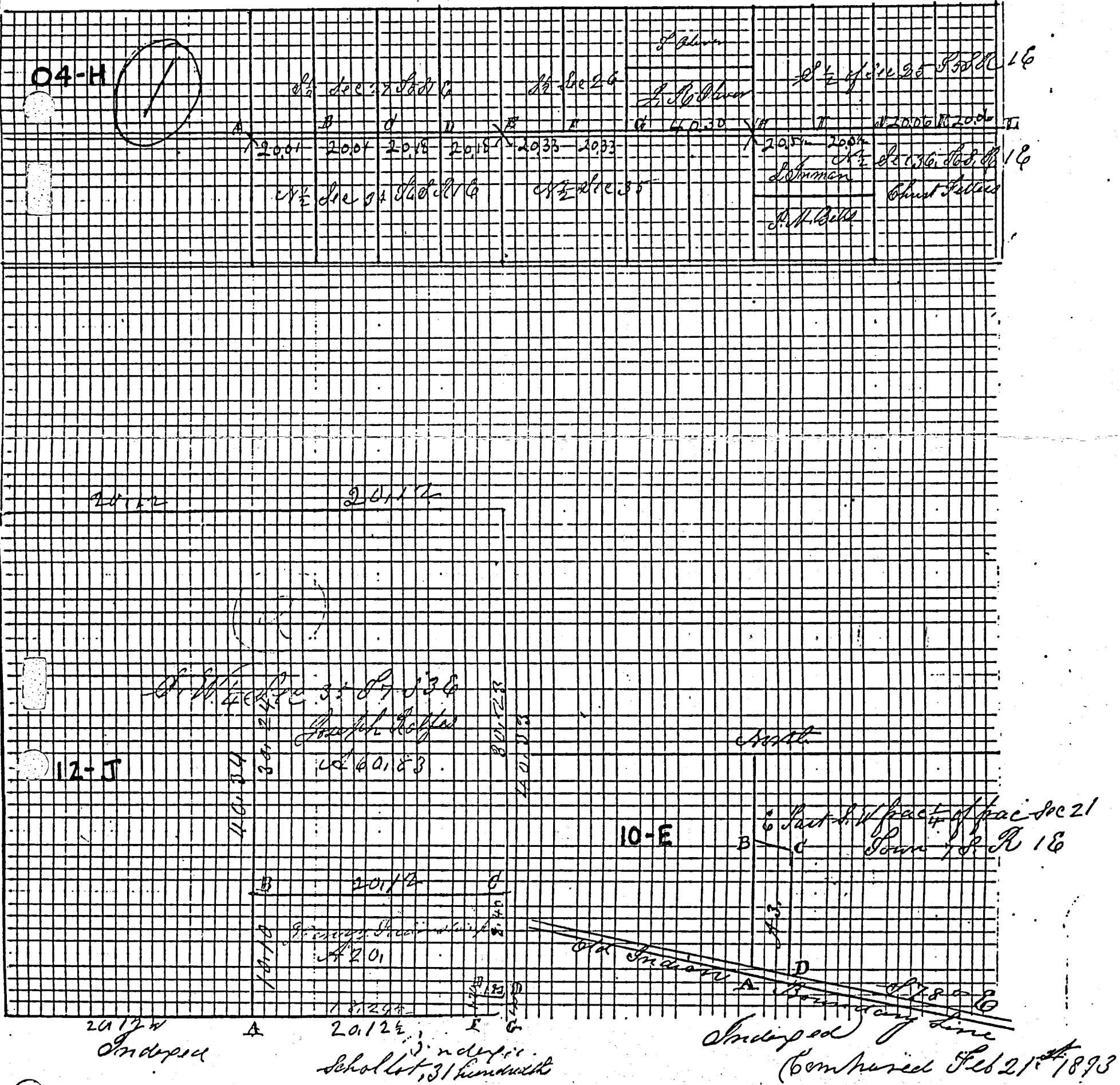

Survey made by me in the West side of E part of SW 1/4 of
 Sec 21, T. 21 N., R. 16 E. at East of Owner
 Stone in survey Jan 1868 Stone 18.18.12 Hickory 6 N 33 1/2 W 63
 Sh Stone 12.12.9 Sweet Oak 20 N 20 W 44
 Sh Stone 10.6.6 Sweet Oak 14 S 53 1/2 W 124
 Sh Stone 15.8.4 North 14 North 221 not marked
 R. ... Mr. ... 1864