

PLAT OF SURVEY FOR SCHWIETERMAN ESTATE

SW SITUATED IN:
THE SE 1/4, SECTION 28
SW 1/4 SECTION 29 AND THE
NW 1/4 SECTION 33
TOWN 4 S. RANGE 3 E.,
UNION TOWNSHIP,
MERCER COUNTY, OHIO

NORTH AND BEARING
SYSTEM BASED ON
MERCER COUNTY
LOCAL DATUM.

WENCO ENTERPRISES, LLC.
INST. # 201800002469
57.3996 AC.

93.574 ACRES

80.791 ACRES
IN SECTION 28
1.017 ACRES IN R/W

RYAN J. & ANGELA L.
SCHWIETERMAN
INST. # 201700000100
80 AC.

RYAN J. & ANGELA L.
SCHWIETERMAN
INST. # 201700000100
80 AC.

SOUTHWEST CORNER
SOUTHWEST QUARTER
SECTION 28

SOUTHEAST CORNER
SOUTHEAST QUARTER
SECTION 29

SOUTHEAST CORNER
WEST HALF
SOUTHWEST QUARTER
SECTION 28

RYAN J. & ANGELA L.
SCHWIETERMAN
INST. # 201700000100
11.3 AC.

MICHAEL GLEN HARNER
INST. # 201800002269
40 AC.

MICHAEL GLEN HARNER
INST. # 201800002269
80 AC.

LEGEND:

- PK NAIL FOUND
- △ SPIKE FOUND
- 8" CONCRETE POST FOUND
- MONUMENT BOX FOUND
- 5/8" IRON PIN FOUND
- 6" IRON PIPE FOUND
- MAG NAIL SET
- 5/8" IRON PIN W/ CAP SET

CURVE	ARC LENGTH	RADIUS	DELTA ANGLE	CHORD BEARING	CHORD LENGTH
C1	144.09'	763.94'	10°48'25"	N63°36'05"W	143.88'
C2	231.09'	782.50'	16°55'15"	S66°40'55"E	230.25'

NOTES:
FOUND MONUMENTATION IN GOOD CONDITION
UNLESS OTHERWISE NOTED.
DATA SOURCES INCLUDE DOCUMENTS CITED.
A TITLE SEARCH IS RECOMMENDED TO DETERMINE
EASEMENTS, RESTRICTIONS, AND/OR OTHER
ENCUMBRANCES AFFECTING THE PROPERTY
SHOWN HEREON.

**HOWBERT
SURVEYING, L.L.C.**

8477 MERICLE ROAD
FORT JENNINGS, OHIO 45844
PH 419-863-0289

DATE: 9/26/18
CLIENT: SCHWIETERMAN
JOB #: 278-09-18

REV.:
SCALE: 1" = 300'
CHK:

MICHAEL L. HOWBERT
REGISTERED PROFESSIONAL
SURVEYOR NO. 7959 IN OHIO
SEPTEMBER 27, 2018

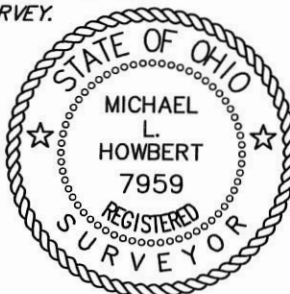

03-H(28)
03-G(29)
03-H(33)

THIS PLAT IS BASED ON AN ACTUAL FIELD SURVEY.

FILE: TSCHWIETERMAN.DWG

0328 300001
 0329 400 006
 0333 100001

BROYLES, SUTTER, WAGNER SURVEY

OF PART OF THE W. 1/2 - S.W. 1/4 - SEC. 28, AND PART OF THE S.E. 1/4 - SEC. 29, AND PART OF THE W. 1/2 - N.W. 1/4 - SEC. 33, TOWN 4 SOUTH, RANGE 3 EAST, (UNION TOWNSHIP), MERCER COUNTY, OHIO.

SEPTEMBER 22, 2012

SCALE 1" = 200'

LOCATION SKETCH

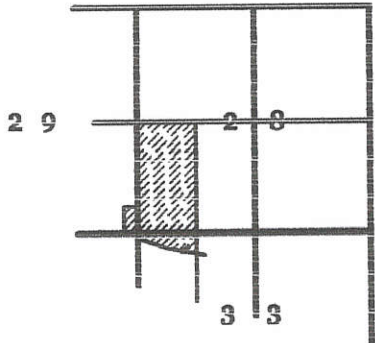

CENTER - SEC. 29

N. LINE - S.W. 1/4 - SEC. 28
 S 89°55'09" E 2652.99'

1326.50'

W. 1/4 POST - SEC. 28

N.E. COR. - W. 1/2 - S.W. 1/4 - SEC. 28

1326.50'

LEGEND

- △ = CORNERSTONE (REFER TO CARPENTER SURVEY BY G. GEESLIN, 2-2-87.
- = P.K. NAIL FOUND.
- = IRON BAR IN MON. BOX FOUND.
- = CONC. POST FOUND.
- ⊙ = MINE SPIKE SET.
- ⊙ = 5/8 INCH IRON BAR SET.



CURVE DATA

C1

Δ = 30°19'44"
 R = 782.50'
 L = 414.21'
 T = 212.08'
 CHORD = S. 73°24'11" E. - 409.39'

C1A

Δ = 16°55'20"
 R = 782.50'
 L = 231.11'
 CHORD = S. 66°41'59" E. - 230.27'

C2

Δ = 10°49'00"
 R = 763.94'
 L = 144.42'
 T = 72.33'
 CHORD = S. 63°38'50" E. - 144.01'

LINDA BROYLES, LANA SUTTER, AND DONNA WAGNER
 VOL. 314 PG. 406
 94.66 ACRES BY TAX MAP

93.628 TOTAL ACRES

(80.809 ACRES IN SEC. 28)

SURVEY REFERENCES :

- 1) CARPENTER SURVEY BY G. GEESLIN, P.S. 5372, 2-2-87.
- 2) CARPENTER SURVEY BY K. MARBAUGH, P.S. 7421, 10-30-10.
- 3) MARCUS SCHUYLER SURVEYS IN SECTIONS 28 AND 33.
- 4) ESMONDE SURVEY, 5-12-98.
- 5) 2 SURVEYS FOR WAGNER DATED THIS DATE.

JEFFREY & PAM RASAWEHR
 INST. # 201000006640
 52.399 AC. BY DEED

N 88°34'03" W 198.00'

POST FOUND 1.3' N. OF COR.

(3.000 ACRES IN SEC. 29)

N.E. COR. - W. 1/2 - N.W. 1/4 - SEC. 33

N.E. COR. - W. 1/2 - N.E. 1/4 - SEC. 33

N. 1/4 POST - SEC. 32

N.W. COR. - SEC. 33

S. LINE - S.W. 1/4 - SEC. 28
 S 88°59'44" E 1328.25'

N 88°59'44" W

N 88°47'26" W

2213.37'

25.93'

236.59'

33.00'

165.00'

21.33'

1328.25'

1332.74'

S 88°34'03" E 2647.96'
 S. LINE - S.E. 1/4 - SEC. 29

N. LINE - N.W. 1/4 - SEC. 33
 (9.819 ACRES IN SEC. 33)

CEMETERY TRACT VOL. 95 PG. 438 0.34 AC. BY DEED 0.318 AC. SURVEY

N. 1/4 POST - SEC. 33

N 01°13'11" E 2661.85'
 (BEARING BASED ON MER. CO. GPS DATUM)
 CENTER - SEC. 32

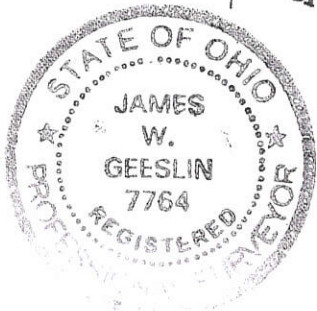

W. LINE - N.W. 1/4 - SEC. 33
 S 01°14'26" W

LINE TABLE

LINE	BEARING	DISTANCE
L1	N 19°54'08" E	41.05'
L2	N 60°01'15" E	168.92'
L3	S 11°19'07" W	174.64'
L4	S 69°03'19" E	134.94'

PI STA. 10+37.30

⊙ MERCER RD.

⊙ KRUGH RD.
 2055.67'

E. LINE - W. 1/2 - N.W. 1/4 - SEC. 33
 N 01°13'02" E 2658.29'

⊙ CELINA - MENDON RD.
 N 01°14'20" E 2656.49'

E. LINE - W. 1/2 - N.E. 1/4 - SEC. 33

S.E. COR. - W. 1/2 - N.E. 1/4 - SEC. 33

S.E. COR. - W. 1/2 - N.W. 1/4 - SEC. 33

GEESLIN LAND SURVEYING

525 S. SECOND ST.
 COLDWATER, OHIO 45828
 PHONE (419) 678-7232

SURVEYED BY

James W. Geeslin
 JAMES W. GEESLIN
 P.S. No. 7764

03-H(28433)
 03-G(29)

03-28-400-001 03-H

LEGEND

- "A" = STONE @ N. 1/4 POST ~ S.E. 1/4 ~ SEC. 28.
- "B" = STONE @ S. 1/4 POST ~ S.E. 1/4 ~ SEC. 28.
- "C" = CONC. MON. FD. FROM SURVEY BY BEN GEBHART DATED 8-30-1973
- "D" = MINE SPIKE SET.
- "E" = 5/8" x 30" IRON BAR SET.

LOCATION SKETCH

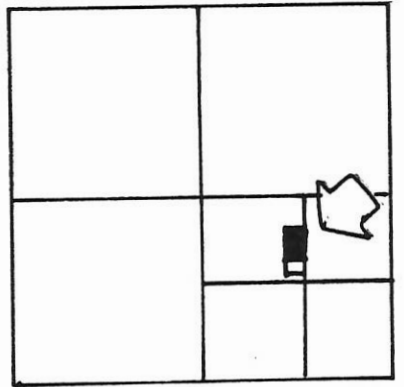

SECTION 28.

SURVEYED BY Gordon L. Geeslin
 GORDON L. GEESLIN
 REGISTERED SURVEYOR
 NO 5372

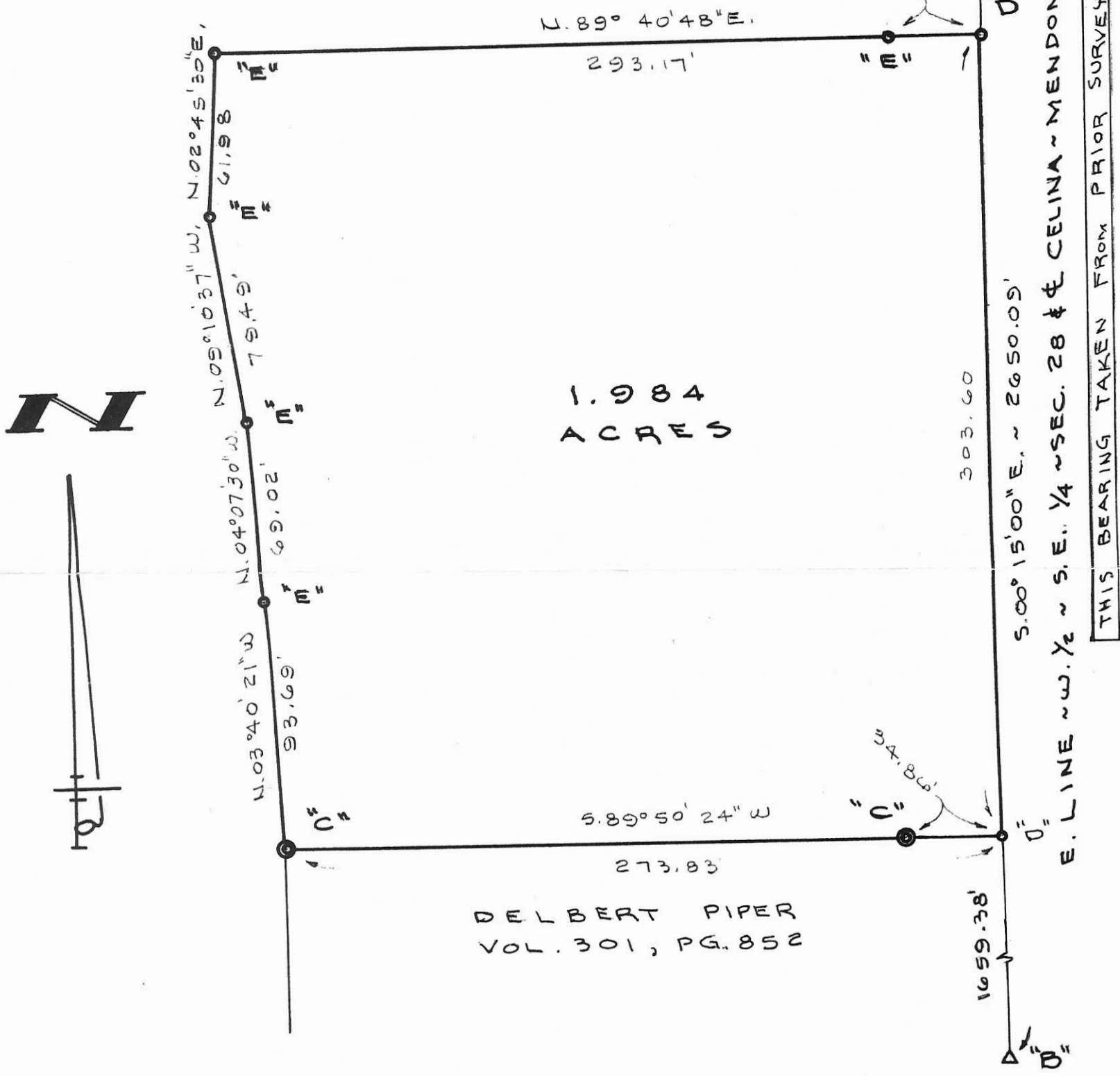

PIPER SURVEY
 PART OF THE N.W. 1/4 OF THE S.E. 1/4 OF SECTION 28, TOWN 4 SOUTH, RANGE 3 EAST (UNION TOWNSHIP), MERCER COUNTY, OHIO
 SEPT. 30, 1994

SCALE 1" = 50'



GORDON L. GEESLIN
 LAND SURVEYOR
 810 EAST MARKET STREET
 CELINA, OHIO
 PHONE (419) 586-6155



PERMANENT PARCEL No. _____

Part of: _____ Sec. _____ T _____ R _____ Township

Grantor: _____ Area Retained: _____ Acres

Grantee: _____ Area Transferred: _____ Acres

Deed References: _____

APPROVALS:

AGENCY: Board of Health	County Sanitary Engineer	County Engineer
DATE: _____		

032840007

N. LINE - S.W. 1/4 - S.E. 1/4 - SEC. 28

N 88°47'53" W 664.17'

370.46'

2.06'

293.71'

LEGEND

- ⊙ = CONCRETE MONUMENT FOUND.
- = 5/8 INCH IRON BAR FOUND.
- ⊙ = 5/8 INCH IRON BAR SET.

SURVEY REFERENCES :

- 1) ESMONDE SURVEY, 5/12/98 .
- 2) ESMONDE SUB-DIVISION PLAT, 4/10/72 .

SURVEYED BY

James W. Geeslin
 JAMES W. GEESLIN
 P.S. No. 7764

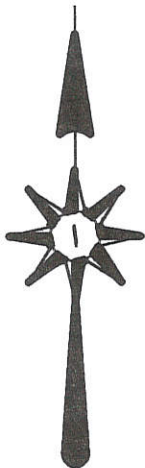

ESMONDE SUB-DIVISION

N 01°06'47" E 725.96'

558.92'

LOT 3

S 88°53'37" E
264.28'

30.00'

LOT 4

164.98'

S 88°53'21" E
264.45'

165.00'

S 01°03'17" W 890.49'

E. LINE - S.W. 1/4 - S.E. 1/4 - SEC. 28
CELINA - MENDON RD.

BRUCE
V. 322 PG. 760
1.59 AC. BY DEED

30.00'

165.00'

SURVEY OF LOT 4 IN ESMONDE
 SUB-DIVISION, IN THE E. 1/2 -
 S.W. 1/4 - S.E. 1/4 - SEC. 28,
 (UNION TOWNSHIP), MERCER
 COUNTY, OHIO .

APRIL 30, 2008



SCALE 1" = 100'

**GEESLIN
 LAND SURVEYING**

107 N. CEDAR ST.
 COLDWATER, OHIO 45828

PHONE (419) 678-7232
 FAX (419) 678-9332

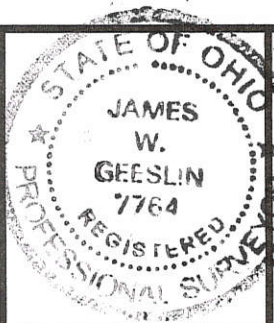

PERMANENT
 PARCEL No. _____

Part of: _____ Sec. _____ T. _____ R. _____ Township

Grantor: _____ Area Retained: _____ Acres

Grantee: _____ Area Transferred: _____ Acres

Dead References: _____

APPROVALS:
 AGENCY:
 DATE:

Board of Health

Township Zoning Officer

County Engineer

03-H(28)

Survey in SE $\frac{1}{4}$
 Sec. 28, T4S-R3E
 Union Twp.
 Mercer Co., OH

Deed References

Vol. - Pg.
 239 - 75
 247 - 567 M-16
 253 - 383
 251 - 594

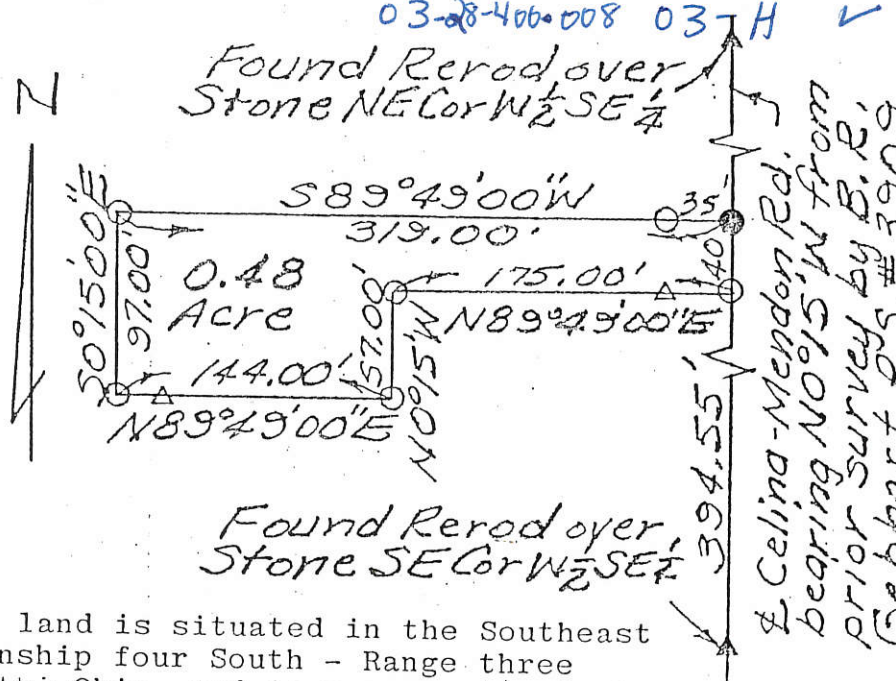

The following described parcel of land is situated in the Southeast quarter Section twenty-eight, Township four South - Range three East, Union Township, Mercer County, Ohio, and is more particularly described as follows:

Commencing at the re-rod found over the stone at the Southeast corner of the west half of said quarter in the centerline of the Celina-Mendon Road; thence North zero degrees fifteen minutes zero seconds West (N0°15'00\"/>

This description and plat represents a true and complete survey made under

George E. Woolley

my supervision on Sept. 13, 1986 and all markers set and called for above are in place.



- = PK Nail set in Wood Stake Found
- ▲ = Rerod over stone found
- △ = Iron Stake Found
- = $\frac{1}{2}$ " Rerod w/Permamark Cap Set

ACCU-TRACE LAND SURVEYS INC.			
George E. Woolley		Reg. Surveyor No. 5772	
David B. Esmonde Sr.			
SURVEYED BY	DATE	DRAWN BY	DATE
K.E.Z.	9-13-86	HEW	9-24-86
SCALE	APP'D	DRWG. NO.	
1"=100'			

FILED IN SURVEY BOOK (SPARE)

JOHN T. HOLT SURVEY
 PT. OF N.E. 1/4 - N.W. 1/4 SECT. 28
 T4S - R3E - UNION TOWNSHIP
 MERCER COUNTY, OHIO
 2-12-65

LOCATION DETAIL: JOHN T. HOLT SURVEY
 PT. OF N.E. 1/4 - N.W. 1/4 SECT. 28, T4S, R3E
 UNION TOWNSHIP - MERCER COUNTY
 OHIO

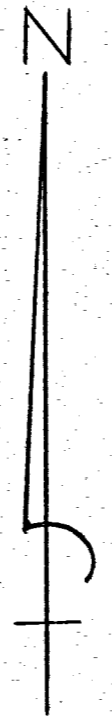
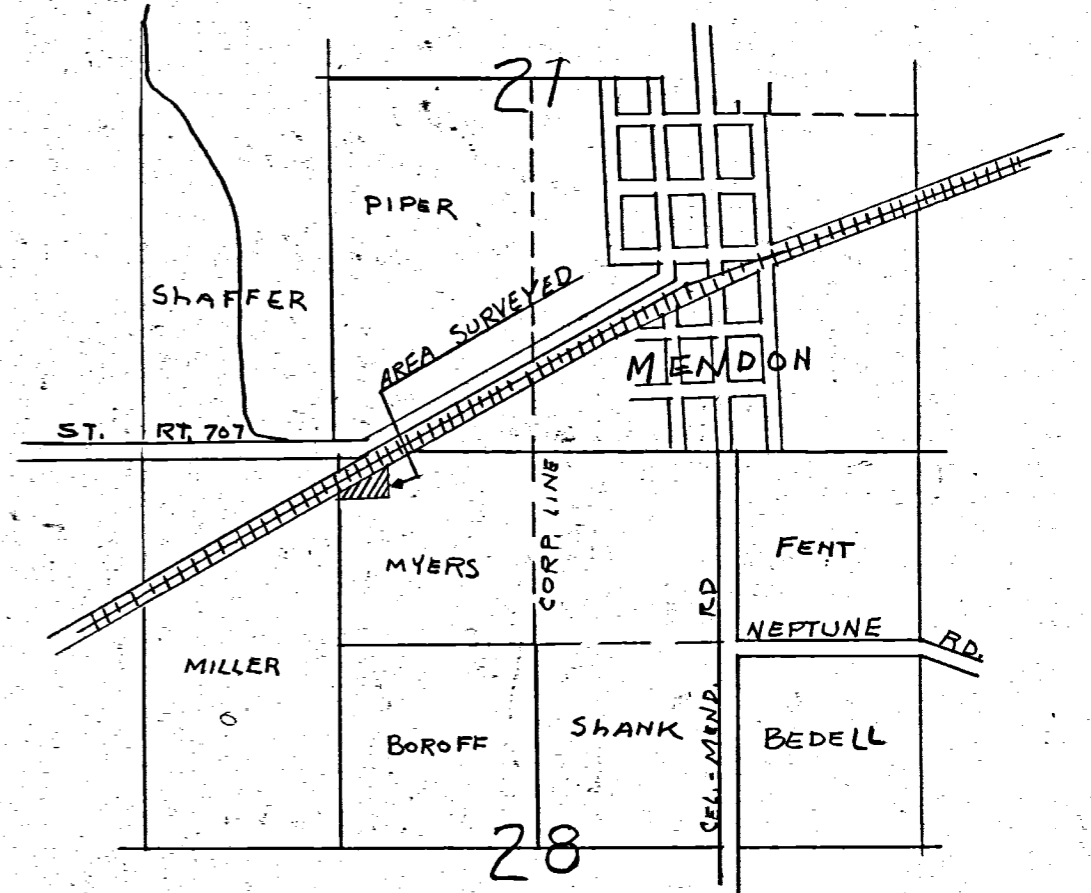
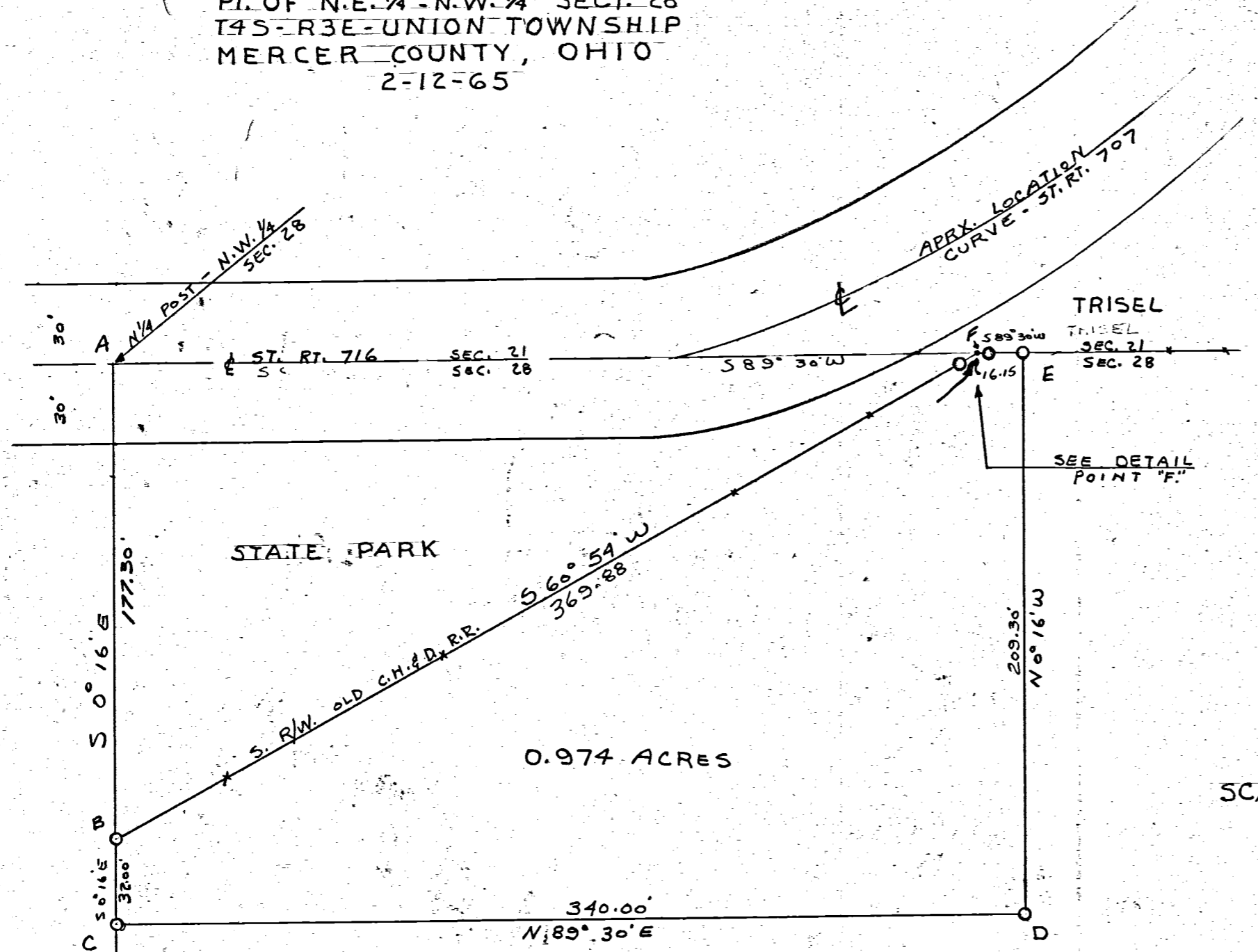

SCALE 1" = 50'

DETAIL PT. "F"

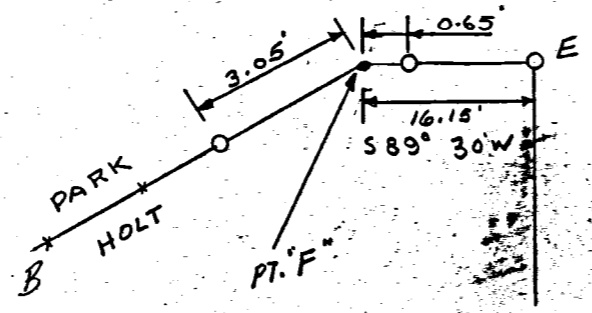

I HEREBY CERTIFY THAT THE ABOVE SURVEY REQUESTED BY MR. HOLT IS CORRECT TO THE BEST OF MY KNOWLEDGE. IRON PIPE SET AS INDICATED BY THE SYMBOL "O". BEARINGS ARE OBSERVED MAGNETIC. FIELD SURVEY BY UHLENHAKE.

B. R. Gehlbart



03-H ✓
03-28-100-004
-005

SURVEY FOR STEVEN WAYNE AND TAMALU BOROFF

BEING PART OF THE NORTHEAST QUARTER, OF THE NORTHWEST QUARTER OF SECTION 28, TOWNSHIP 4 SOUTH, RANGE 3 EAST, UNION TOWNSHIP, MERCER COUNTY, OHIO

BASIS OF BEARINGS
BASIS OF BEARINGS FROM TRISEL SURVEY BY B.R. GEBHART #3909 IN JULY OF 1973.

- REFERENCES:**
- *TRISEL SURVEY BY B.R. GEBHART #3909 IN JULY OF 1973.
 - *CARPENTER SURVEY BY GORDON GEESLIN #5372 IN JANUARY OF 1987.
 - *JOHN T. HOLT SURVEY BY B.R. GEBHART IN FEBRUARY OF 1965.
 - *TOMLINSON ADDITION TO MENDON P.B. 2, PG. 49.
 - *ANSPAUGH FIRST ADDITION P.B. 9, PG. 44.
 - *ANSPAUGH SECOND ADDITION P.B. 10, PG. 40.
 - *RAUCH SECOND ADDITION P.B. 7, PG. 21.

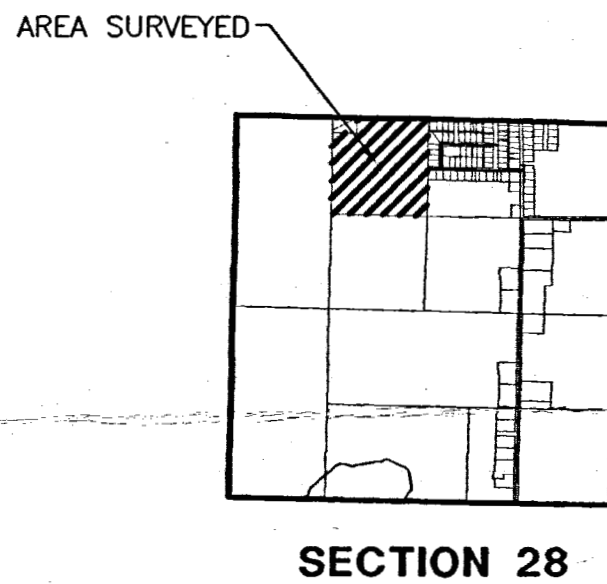

SCALE: 1"=150'



James M. [Signature]
UNION TWP. ZONING INSPECTOR

3-2-05
DATE

[Signature]
CRAIG W. MESCHER P.S. #8237

2/28/05
DATE

PROJECT #205808.03/boroff-survey.dwg

Fanning/Howey
Civil Engineering Division

Engineers Surveyors Consultants
1200 IRMSCHER BOULEVARD, CELINA, OHIO 45822
PH: (419) 586-2292 FAX: (419) 586-3393
www.fhai.com/civilengineering

LEGEND

- △ Section Corner
- Iron Pin Found
- Iron Pin Set
- ⊙ Concrete Post Found
- ⊗ P.K. Nail Found
- P.K. Nail Set

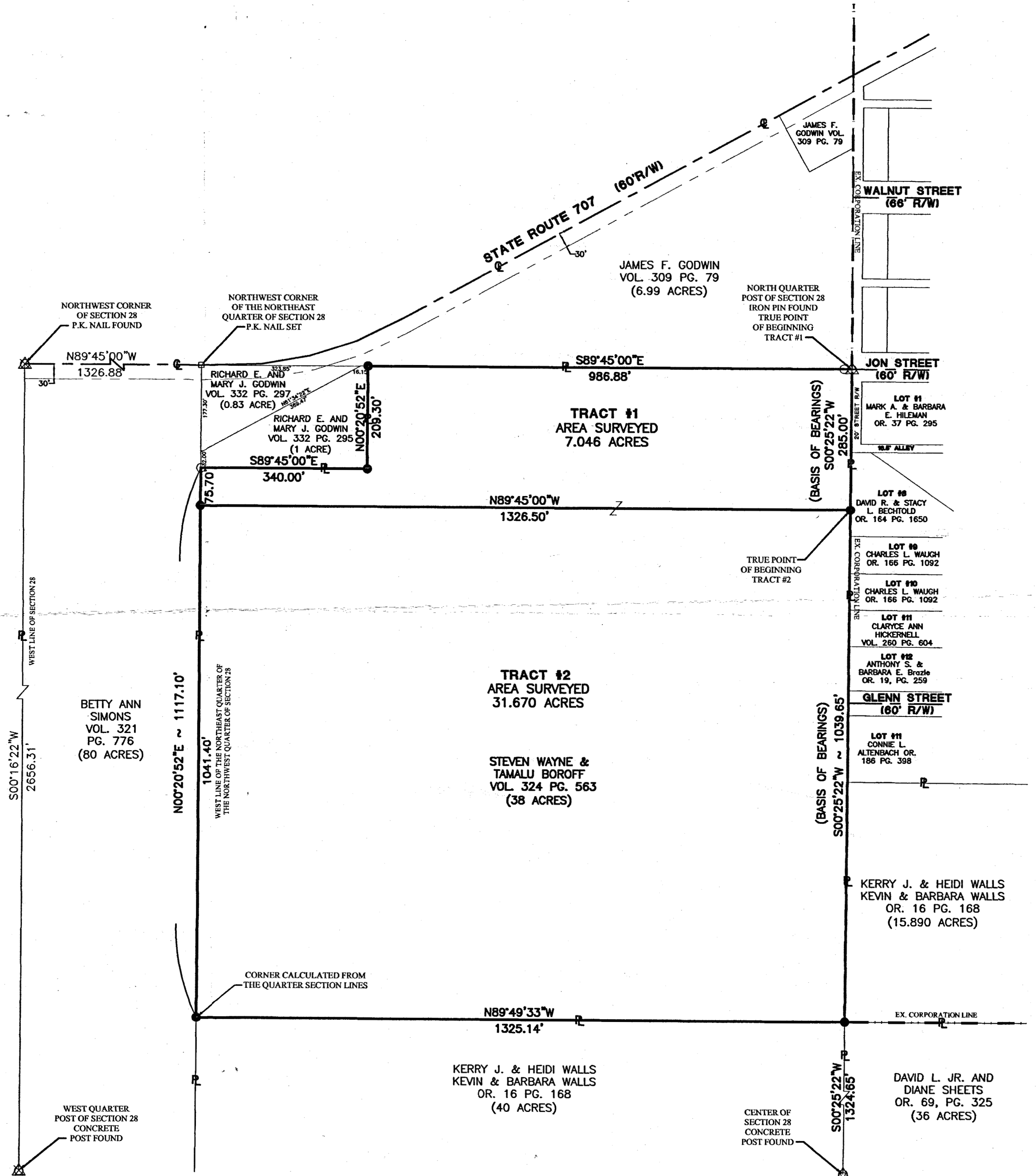

NUTTLE-DIEGEL SURVEY
 PT. NW 1/4 SEC 28, T45, R3E, UNION TWP.
 MERCER COUNTY, OHIO

03-H ✓

032810005

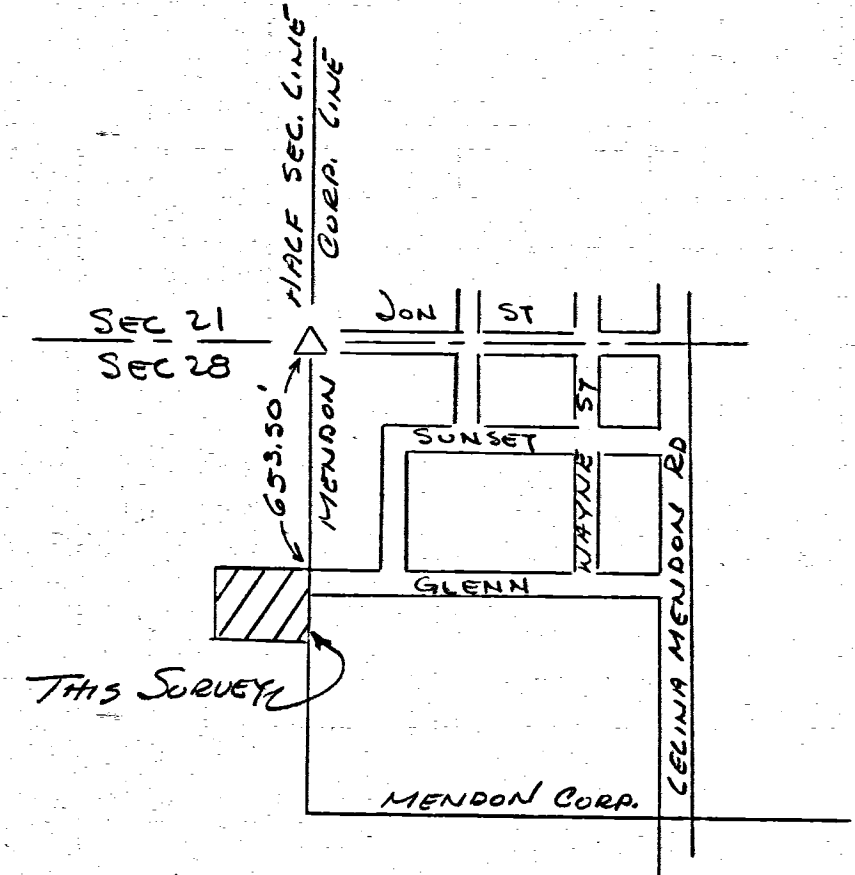
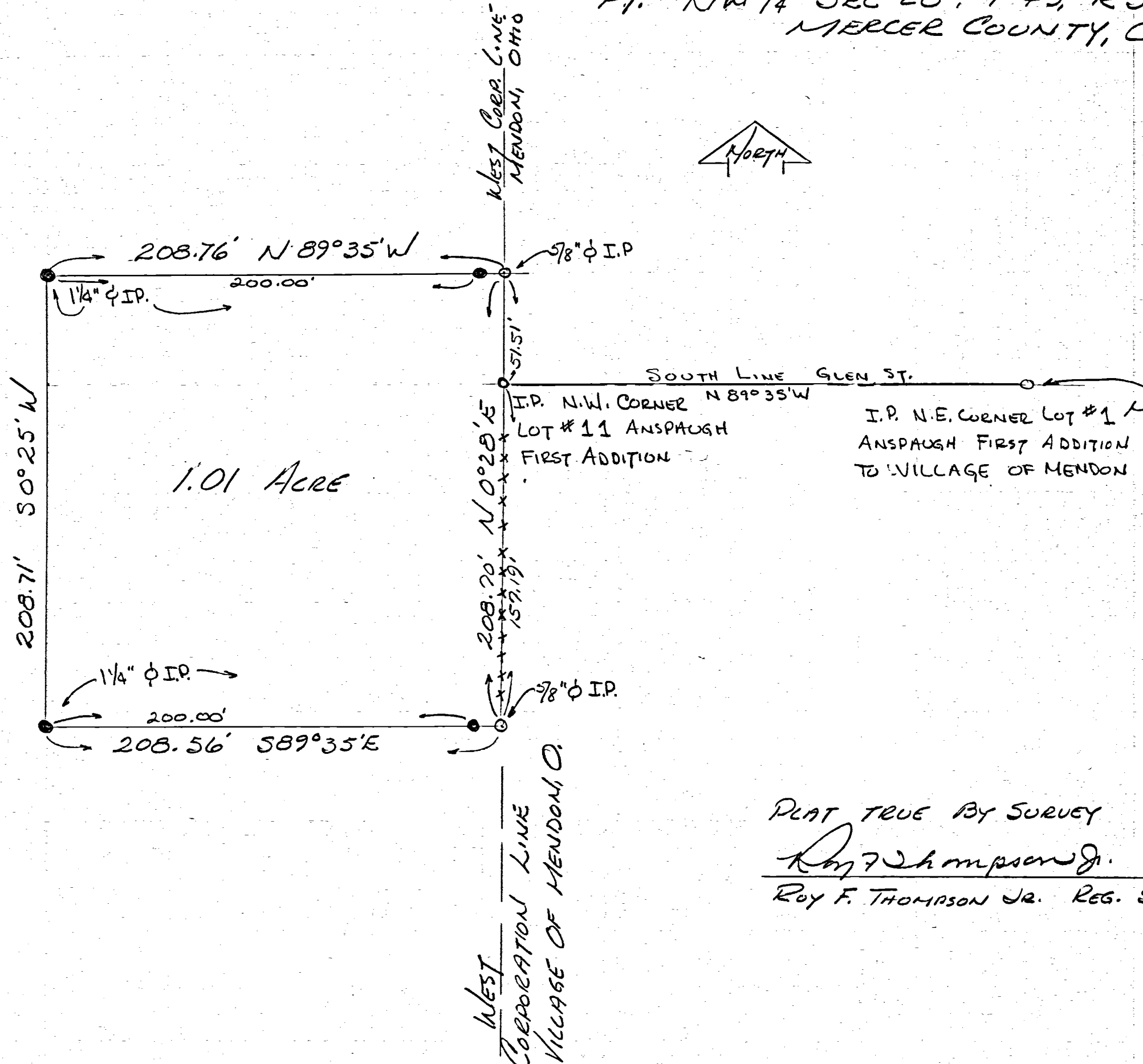

LOCATION PLAT:
 PT. SEC 28 - UNION TWP.
 T45 - R3E - MERCER Co. OHIO

PLAT TRUE BY SURVEY
 Roy F. Thompson Jr. 9/1/79.
 Roy F. THOMPSON JR. REG. SUR. #5379

555

113

0328276005 'A'
0328276006 'B'

LOCATION SKETCH

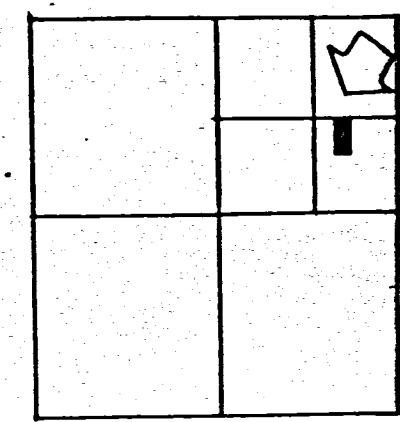

SECTION 28

H-ED 03-2889 ✓

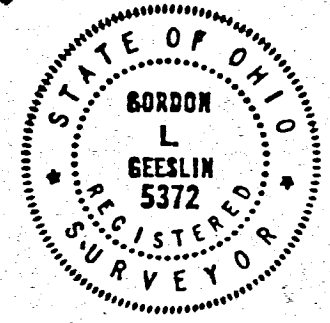

N. LINE - S.E. 1/4 - N.E. 1/4 - SEC. 28 & E. MENDON - NEPTUNE RD.
109° 54' E. = 1340.19' = 18'

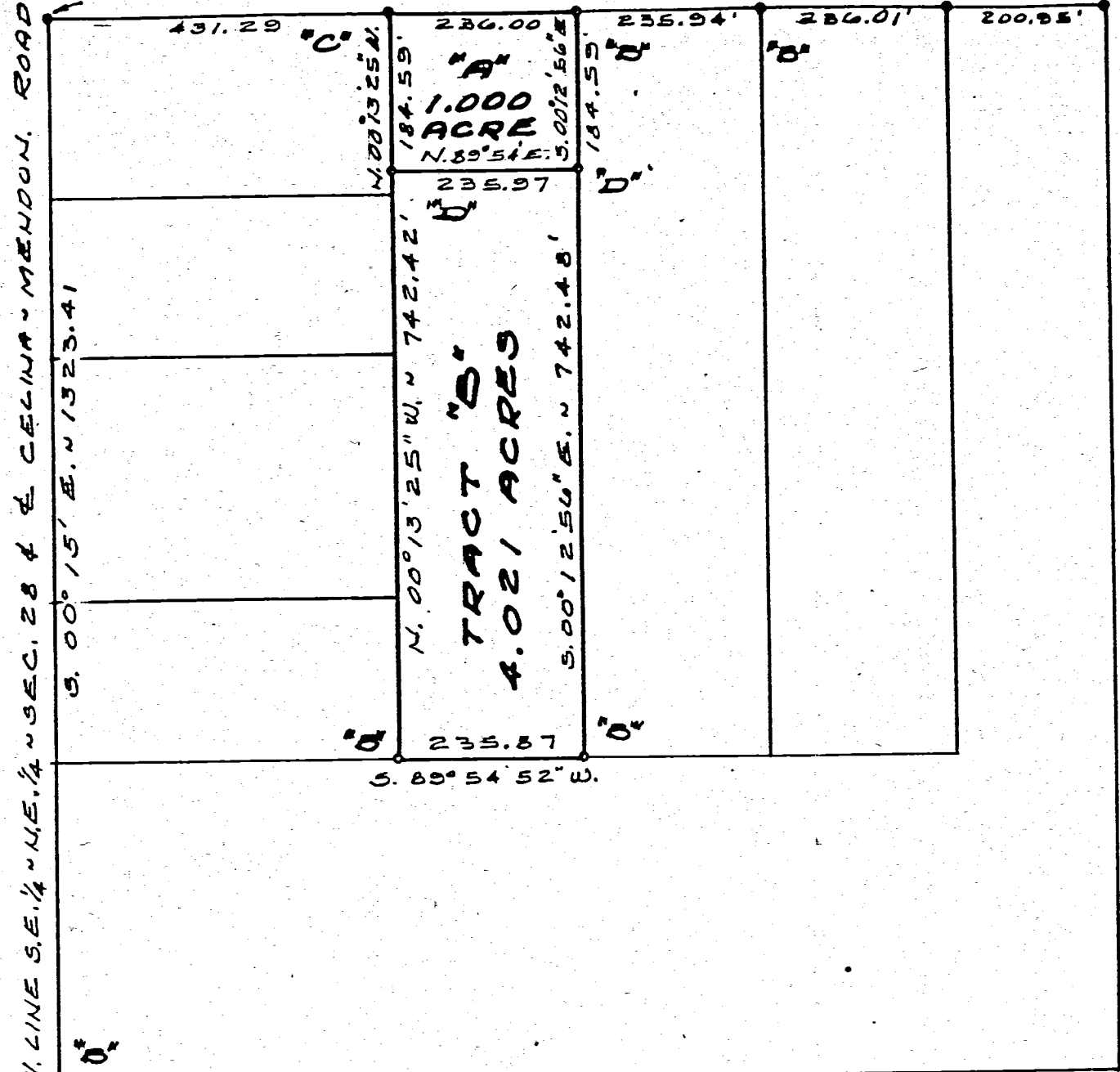

NOTES

- 1) REFERENCE IS MADE TO A SURVEY OF THIS AREA BY B.R. GEBHART, REG. SURV. NO 3909 DATED JULY 5, 1977.
- 2) THE MONUMENTATION FROM GEBHART'S SURVEY ARE ACCEPTED AS INTENT OF THE ORIGINAL SUBDIVIDER.

LEGEND

- "A" = RAILROAD SPIKE FD. 0.24 E. OF CORNER (DIST'S. SHOWN ARE FROM COR. - NOT SPIKE)
- "B" = POINT FOUND FROM GEBHART SURVEY.
- "C" = RAILROAD SPIKE SET
- "D" = 5/8" x 30" IRON BAR SET.

CITIZENS COMMERCIAL BANK SURVEY - PART OF THE S.E. 1/4 OF THE N.E. 1/4 OF SECTION 28, TOWN 4 SOUTH, RANGE 3 EAST (UNION TWP.), MERCER COUNTY, OHIO.

MAY 26, 1983

SCALE 1" = 200'

SURVEYED BY Gordon L. Geeslin
GORDON L. GEESLIN
REGISTERED SURVEYOR
NO 5372
CELINA, OHIO



RAIL STONE

69

PRELIMINARY PLAT
 ESMONDE SUB-DIVISION
 PT. E 1/2 SW 1/4 SE 1/4 SEC. 28, T4S, R3E
 UNION TWP., MERCER CO., OHIO
 MARCH 1972

PRELIMINARY PLAT
 ESMONDE SUB-DIVISION
 PT. E 1/2 SW 1/4 SE 1/4 SEC. 28, T4S, R3E
 UNION TWP., MERCER CO., OHIO
 MARCH 1972

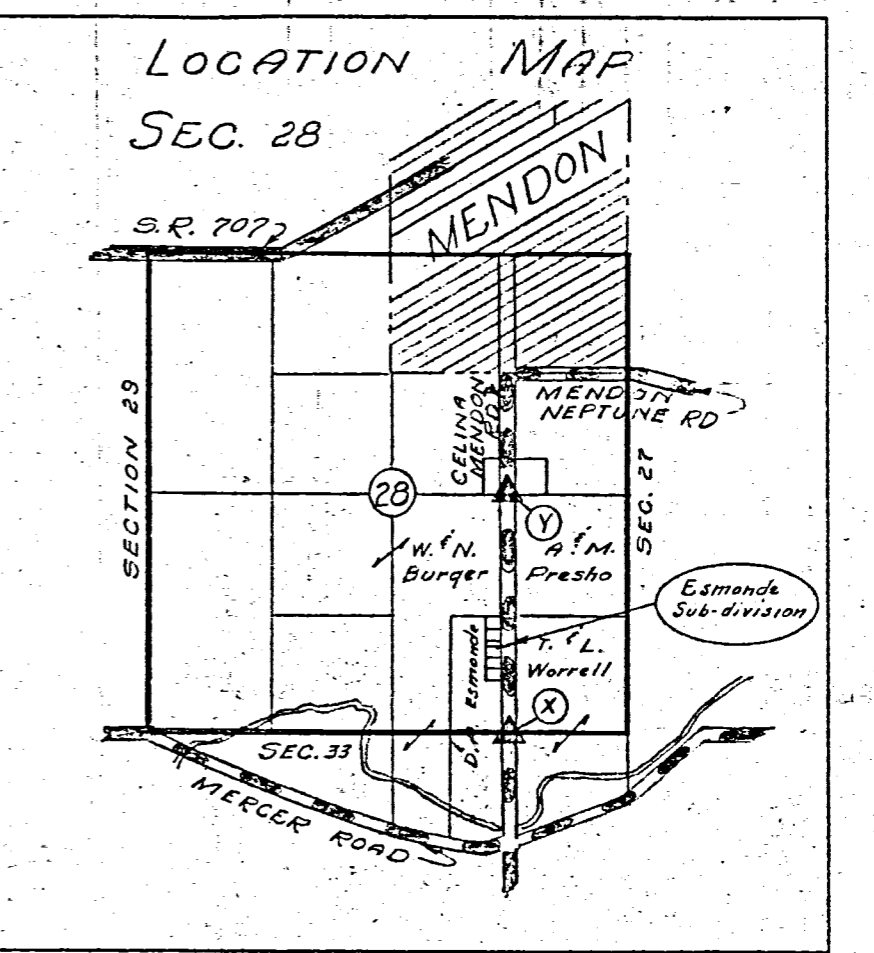
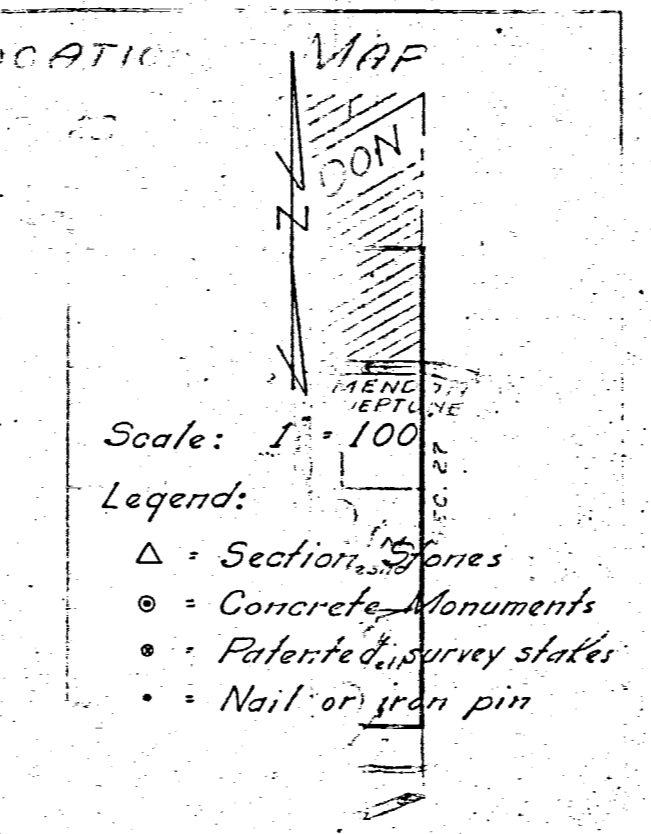
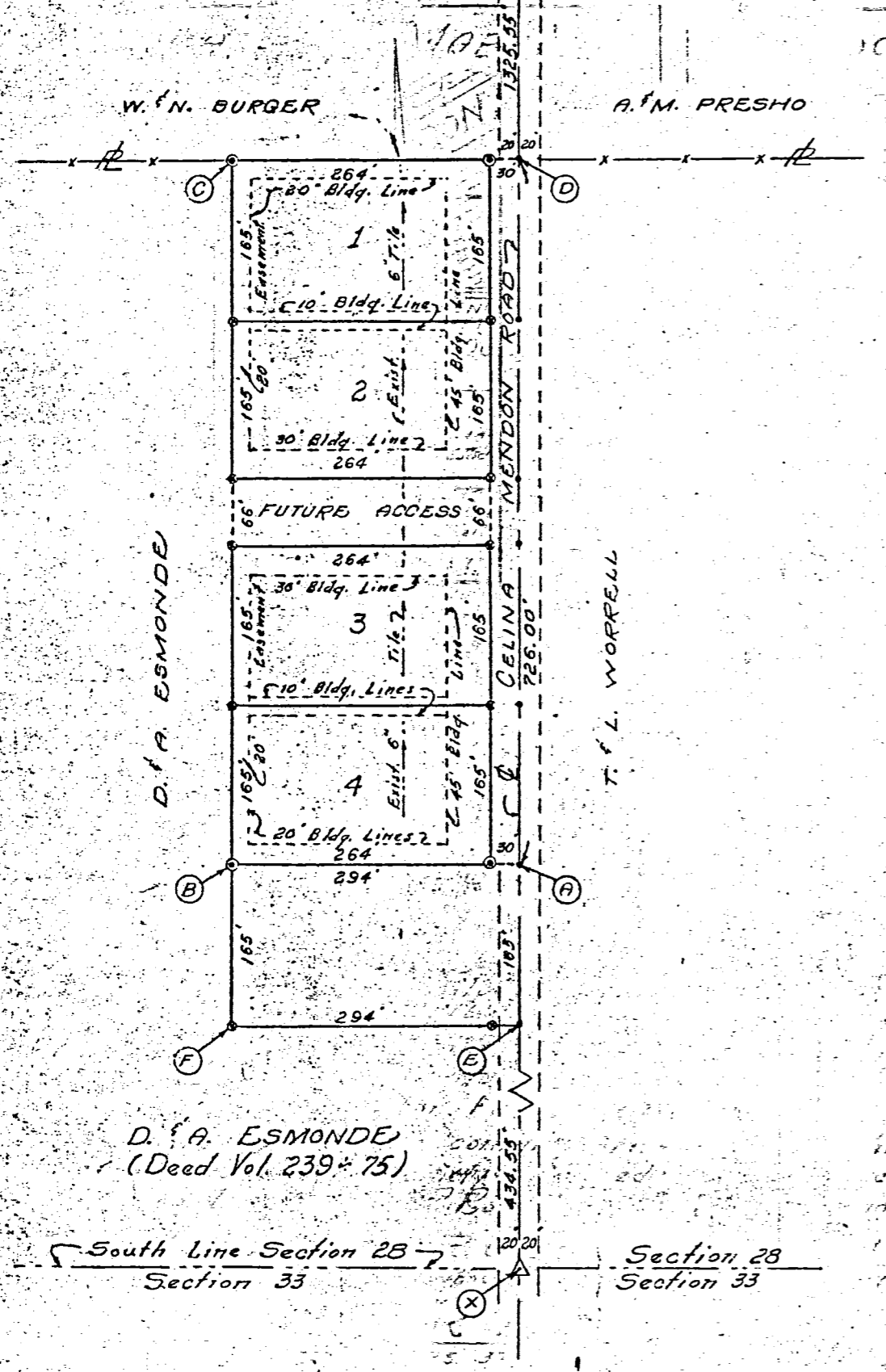

Scale: 1" = 100'
 Legend:
 Δ = Section Corners
 ⊙ = Concrete Monuments
 ⊙ = Patented survey stakes
 • = Nail or iron pin

CERTIFICATE:
 The proposed "ESMONDE SUB-DIVISION" is located in the E 1/2 SW 1/4 SE 1/4 of Sec. 28, T4S, R3E, Union Township, Mercer Co., Ohio and consists of four (4) lots, each containing one (1) acre of land exclusive of the right of way of the Celina & Mendon Road. An area sixty six (66) feet width will be left between lots two (2) and three (3) for access for future development.
 The entire tract in this sub-division contains four and ninety hundredths (4.90) acres of land, owned by David B. Esmonde, Sr., and Anna L. Esmonde, R.R. 1, Mendon, O.
 This Preliminary Plat prepared by B.R. Gebhart, P.E. at his office, P. S. in the State of Ohio, 204 Dogwood, Celina, Ohio.
 B.R. Gebhart
 P.S. 3909

38

037H

03-H
03-28-400-004
-005
-006
-007

PRELIMINARY PLAT
ESMONDE SUB-DIVISION
PT. E 1/2 SW 1/4 SE 1/4 SEC. 28, T4S, R3E
UNION TWP., MERCER CO., OHIO
MARCH 1972

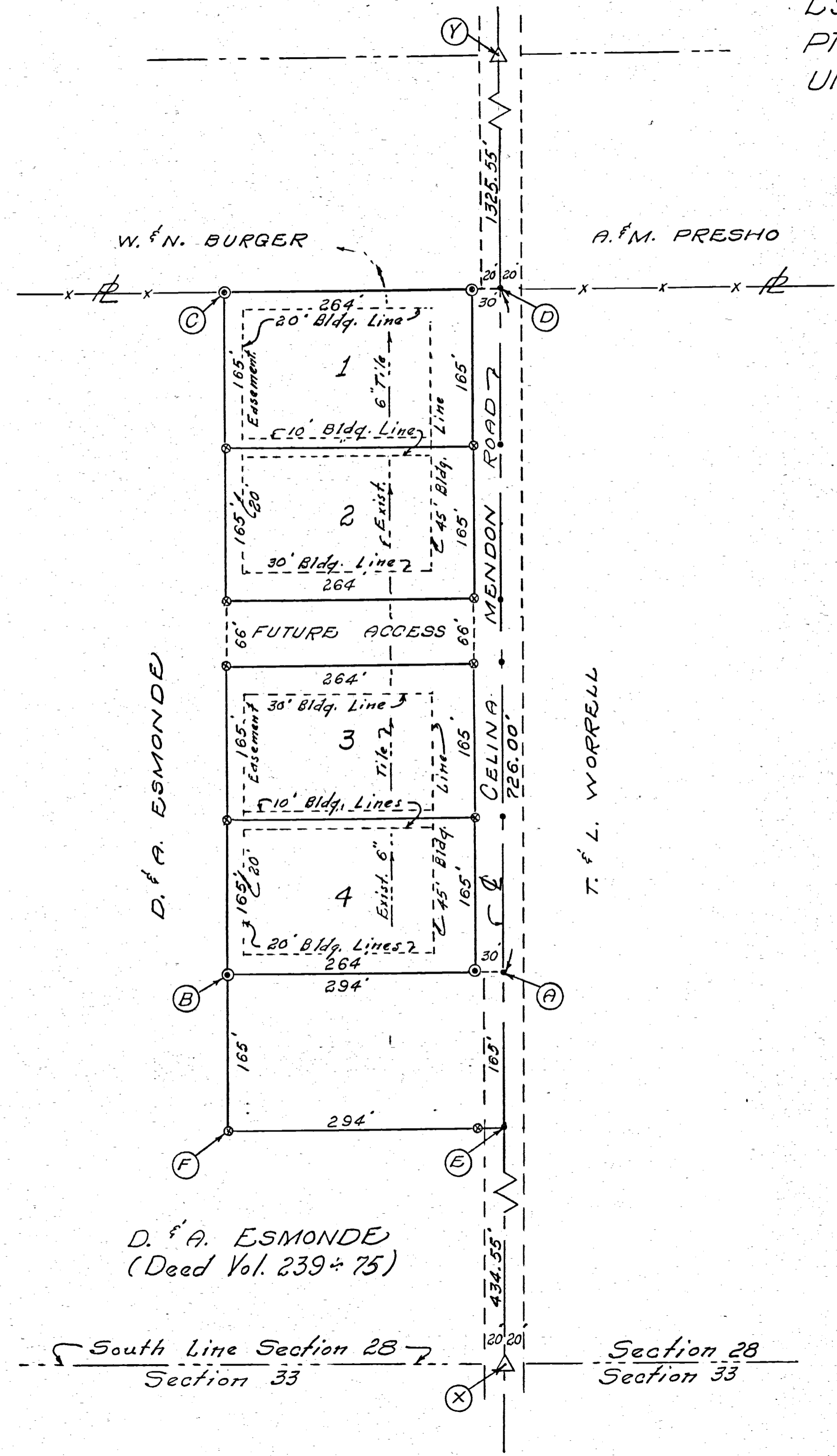

Scale: 1" = 100'

Legend:

- △ = Section Stones
- ⊙ = Concrete Monuments
- ⊗ = Patented survey stakes
- = Nail or iron pin

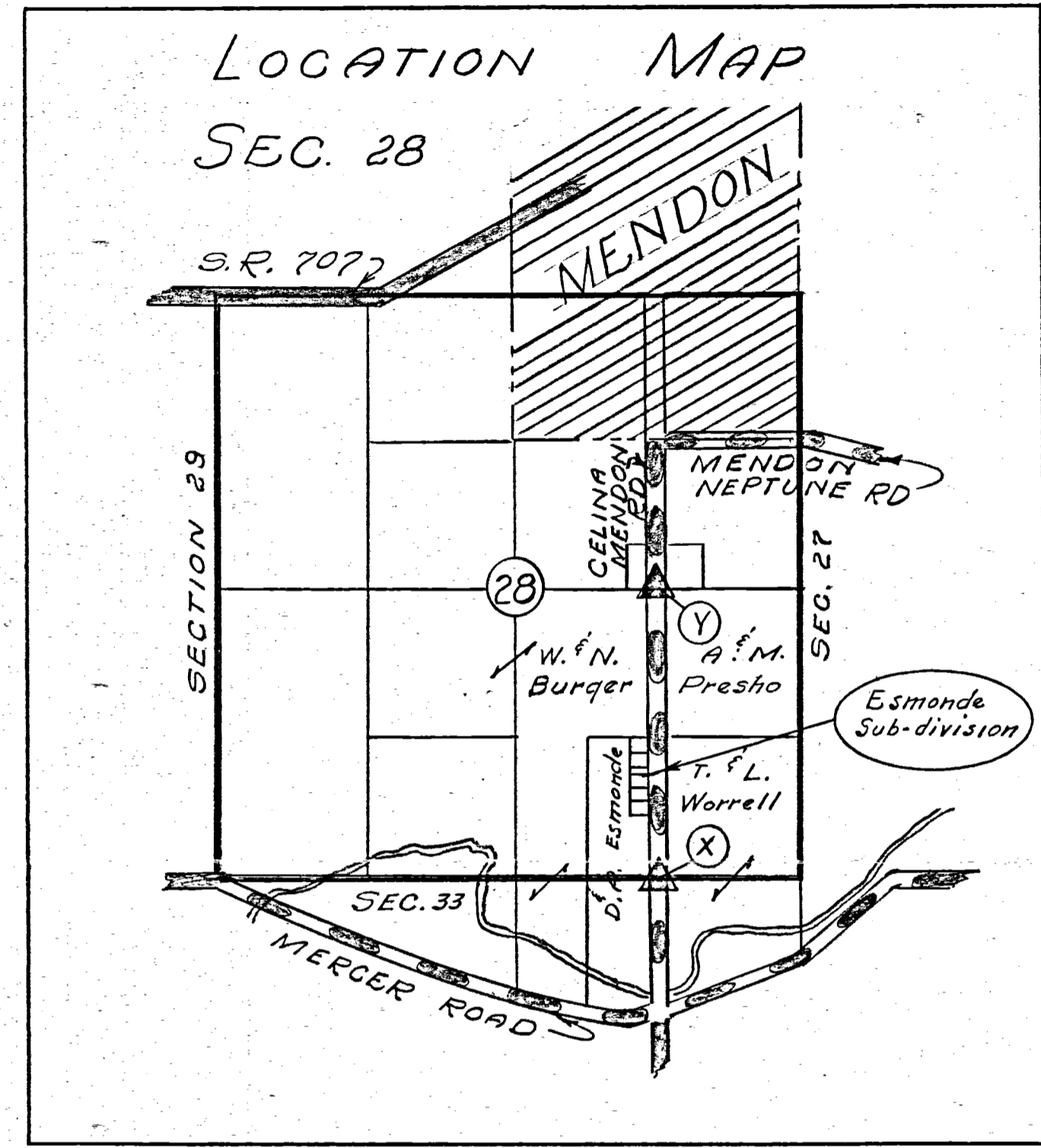

CERTIFICATE:

The proposed "ESMONDE SUB-DIVISION" is located in the E 1/2 SW 1/4 SE 1/4 of Sec. 28, T4S, R3E, Union Township, Mercer Co., Ohio and consists of four (4) lots, each containing one (1) acre of land exclusive of the right of way of the Celina & Mendon Road. An area sixty six (66) feet wide will be left between lots two (2) and three (3) for access for future development.

The entire tract in this sub-division contains four and ninety hundredths (4.90) acres of land, owned by David B. Esmonde, Sr., and Anna L. Esmonde, R.R. 1, Mendon, O.

This Preliminary Plat prepared by B. R. Gebhart, P.E. and P. S. in the State of Ohio, 204 Dogwood, Celina, Ohio

3/15/72

B. R. Gebhart
B. R. Gebhart, P.S. 3909

D. & A. ESMONDE
(Deed Vol. 239-75)

South Line Section 28
Section 33

Section 28
Section 33

ESMONDE SURVEY

PT. E 1/2 SW 1/4 SE 1/4 SECTION 28, T4S, R3E,
UNION TWP., MERCER CO., OHIO

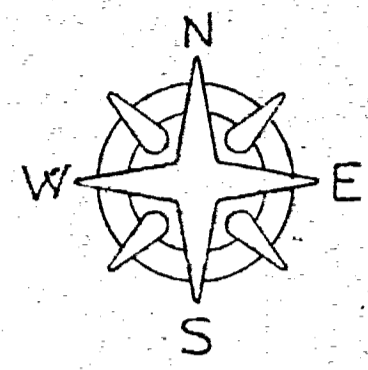
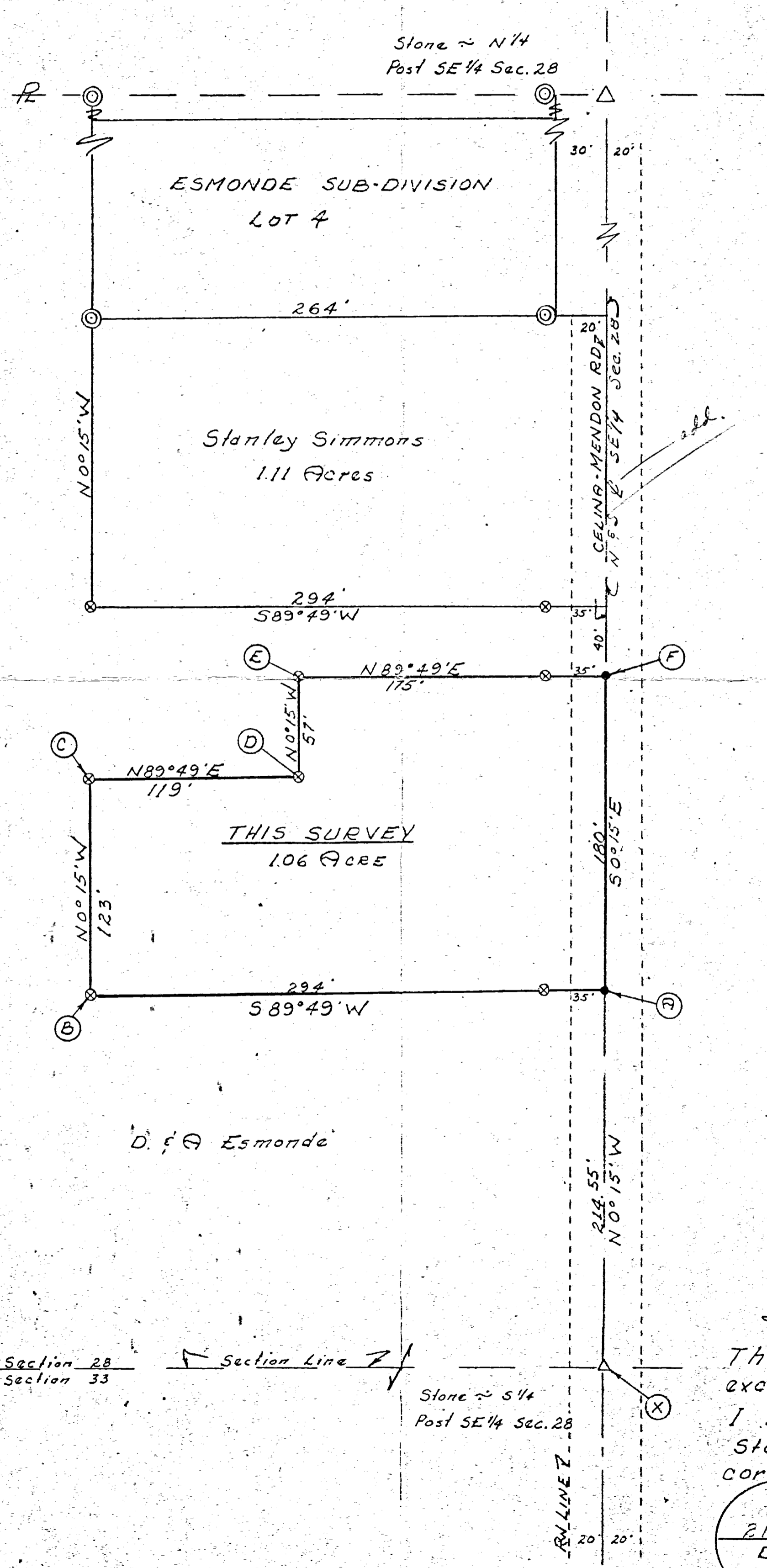

SCALE 1" = 50'

Legend:

- △ = Section Stone
- ⊗ = Patented Survey Stake
- ⊙ = Concrete Monument

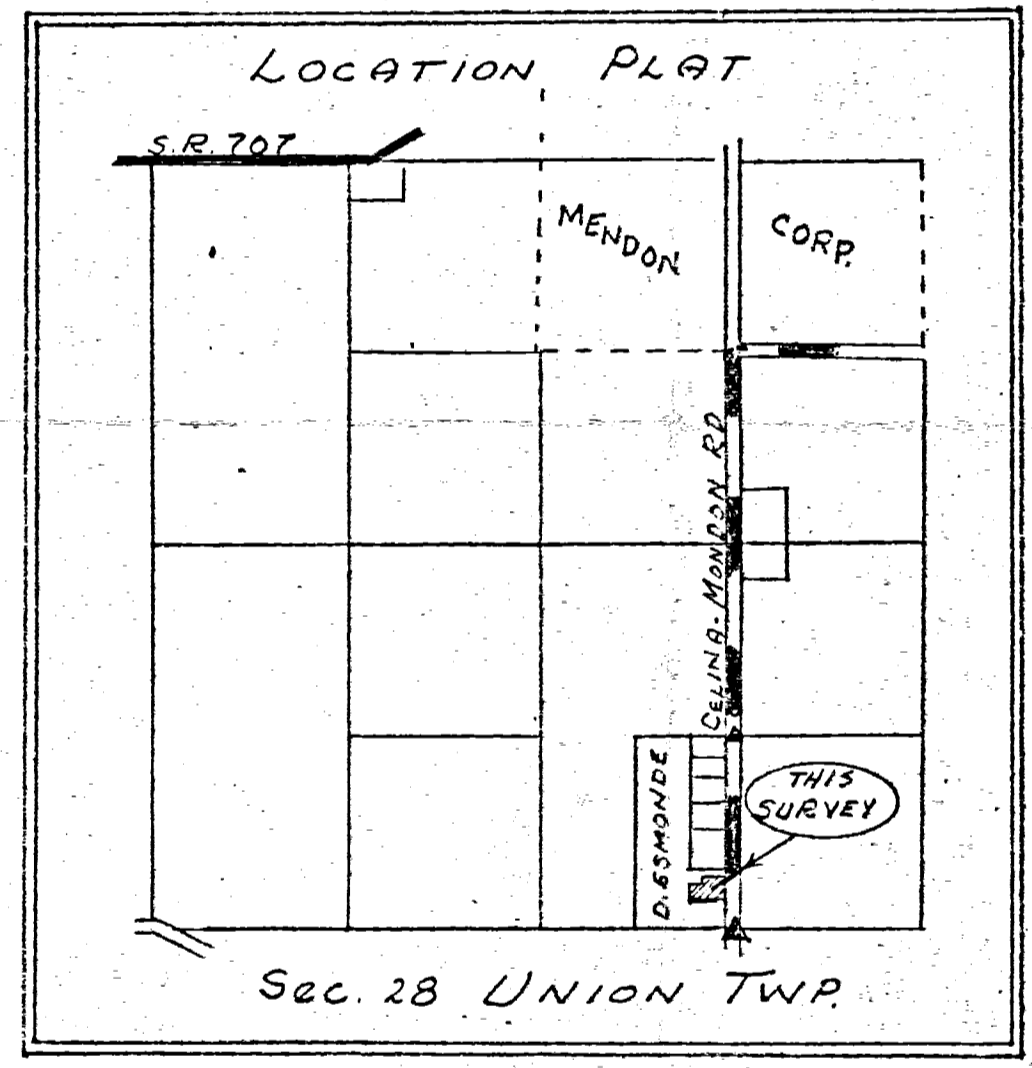

D. & A. Esmonde

D. & A. Esmonde

SURVEYOR'S CERTIFICATE:

This survey at the request of and for the exclusive use of David Esmonde. I hereby certify this survey showing Sec. Stones and iron stake markers to be correct to the best of my knowledge

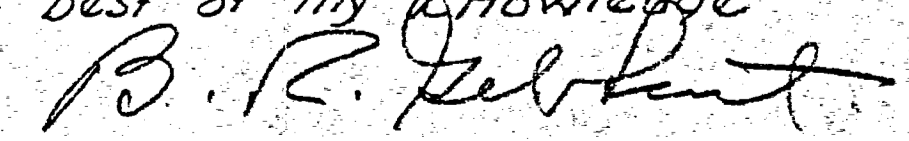
 B. R. GEBHART P.S. NO. 3909

2/22/72 corrected
DATE

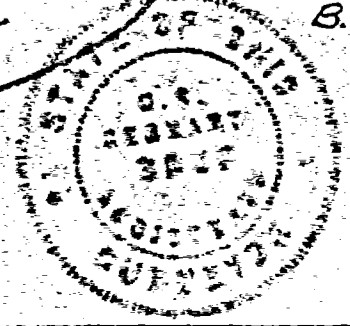

BURGER SURVEY
 PART NW 1/4 SE 1/4 SECTION 28
 T4S, R3E, UNION TOWNSHIP
 MERCER COUNTY, OHIO

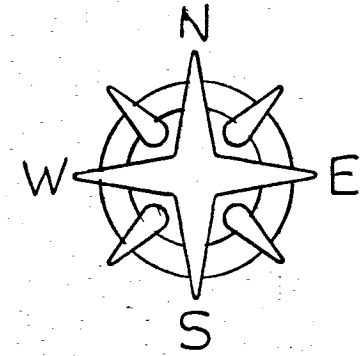

SCALE 1" = 40'

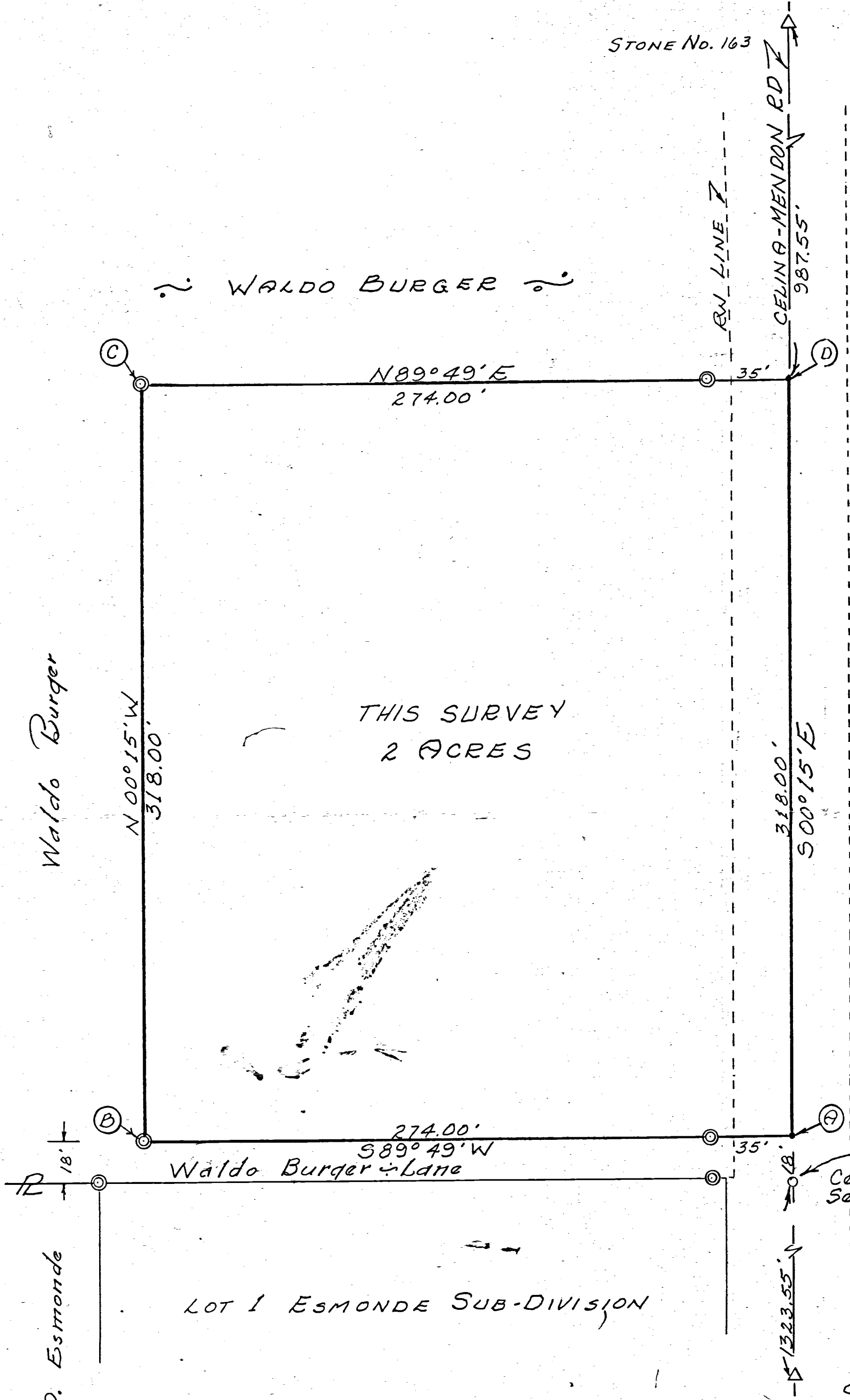
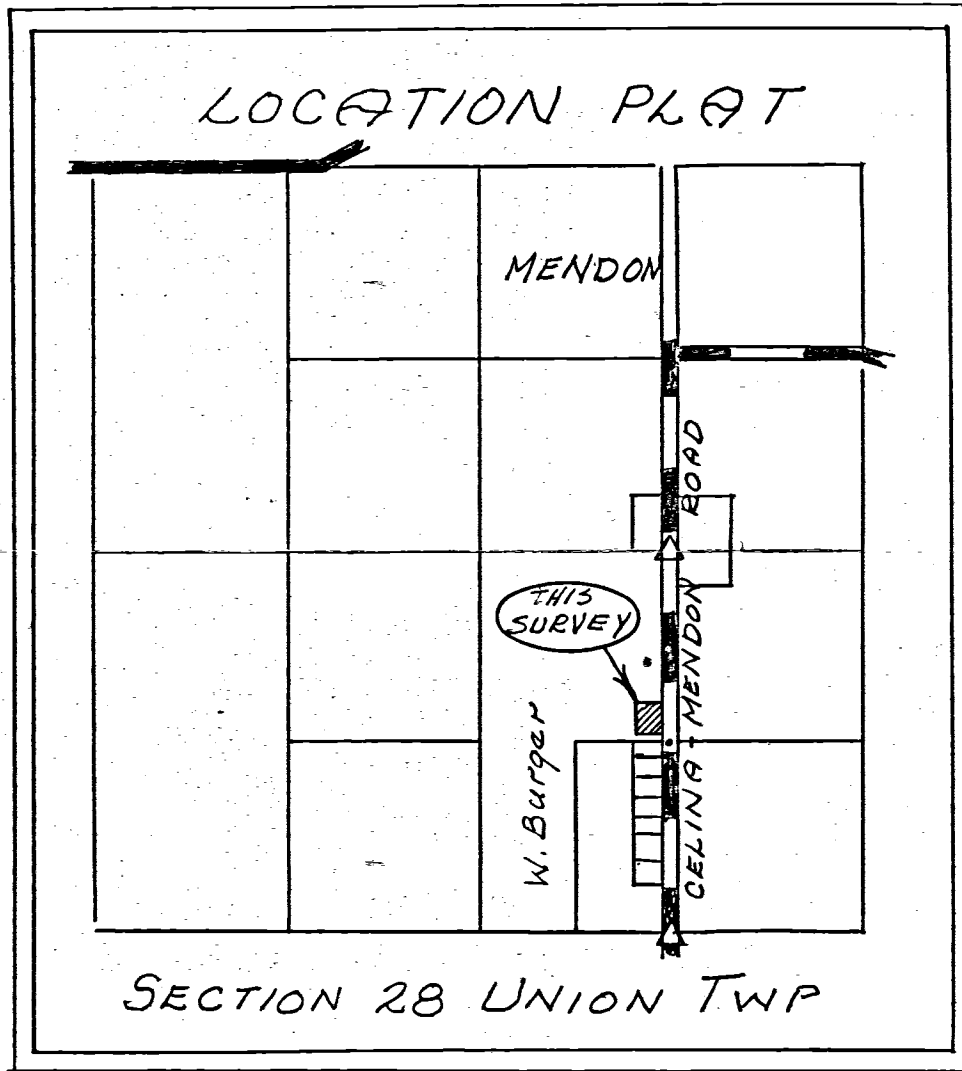

THIS SURVEY
 2 ACRES

Legend:

- △ = Section Stone
- ⊙ = Concrete Monument
- = Harrow Tooth
- = P.K. Nail

SURVEYOR'S CERTIFICATE:

This survey at the request of, and for the exclusive use of, Waldo Burger.

I hereby certify this survey showing section stones and Concrete Mon. markers to be correct to the best of my knowledge

8/30/73

B.R. Gebhart
 Reg'd. Surveyor #3909

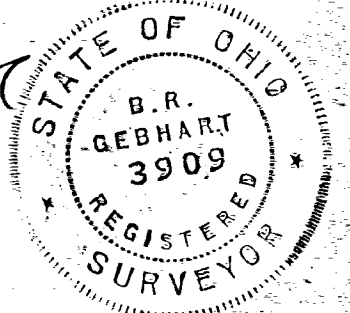

ROAD RECORD

①

Sec 28 T45 R3 E Union Township
Notes of Survey made by me in Sec 28 T45 R3 E
on the 21, 22 and 23 days of Oct. 1885 at the Inst
of J. H. Coil C. Mahony J. W. Prasho J. P. Peterson
E. P. Murlin Justin Hamilton and D. F. Perrott

- A S. E. corner of sec S. L. Stone 15. 10. 8 Walnut 10 East 9 3/4
- B Stake and Stone 10. 6. 5 Red Oak 14 N 48 1/2 E 67 do 20 8 88 E 69
- C E 1/4 P lime stone corner found correct Ash green W. Oak 38 8 66 E 66
- D Stake and Stone 18. 14. 14 no trees
- E S. Limestone 16. 6. 5 Burr Oak 11 N 59 W 39 3/4
- F S. Limestone 12. 4. 4 Burr Oak 22 N 44 W 36 Burr Oak 19 8 24 E 32
- G N 1/4 Post trees gone line bisected S. Stone 18. 7. 6 no trees
- H Stone 13. 8. 6 W Oak 18 N 30 W 53
- I S. Limestone 16. 8. 4 Hickory 8 N 46 E 28 O. M. Burr Oak 12 N 39 W 49
- J W. P. old Hickory green marked new Sycamore 14. N 74 E 33 S. Stone 24. 5. 4
- K S. W. corner of sec Stone in former survey Elm 15 N 80 W 19 B O 20 8 25 7 52
- L S. L. Stone 18. 14. 4 Honey Locust North 4 links size not given
- M S. P. line bisected Stake S. Stone 12. 7. 6 no trees
- N S. L. Stone 22. 14. 12 Apple 12 N 89 E 46 3/4 corner trees
- O S. Stone 15. 15. 6 triangular White Oak 14 S 49 E 23 not marked
- P S. Stone and Stone 18. 12. 6 White Oak 24 8 38 184 Burr Oak 22 N 45 E 110
- Q Stake and Stone 20. 12. 4 W Oak 22 8 36 E 54 do 10 N 59 W 60
- R S. L. Stone 20. 5. 4 Hickory 4 8 7 W 4 1/2 N. M. Hickory 10 8 30 1/2 E 46 marked
- S S. Limestone 14. 6. 4 no trees
- T S. L. Stone 20. 6. 4 Burr Oak 20 N 11 E 7 1/2 Hickory 15 N 57 1/2 E 82
- U Stake and Stone 17. 6. 6 Burr Oak 20 N 85 E 44 1/2 Burr Oak 22 8 13 E 45 1/2
- V S. Limestone 22. 7. 4 White Oak 38 8 64 1/2 W 64 1/2
- W Stake and Stone 16. 7. 6 Hickory 18 N 86 E 111 Sweet Oak 22 8 42 W 172
- X Stone 12. 6. 4 S. Stone 12. 8. 7 no trees
- Z Stake Limestone 12. 6. 5 triangular Burr Oak 8 N 64 1/2 E 15 1/2 W Oak 20 8 60

The above notes I hereby certify correct to the best of
my knowledge and belief
Oct 23rd 1885. M. Schuyler Surveyor of Union Township

The above notes of survey by me were copied by me from
note Book 22 Pages 142, 143 and 144 and are correct
Bellevue 8th 1892 Marcus Schuyler Surveyor