

- Legend:**
- ▲ Cornerstone @ the W1/4 post of Section 9
 - △ Mag nail @ the NW corner of Section 9
 - ▲ Cornerstone @ the N1/4 post of Section 9
 - ⊗ Cornerstone @ the center of Section 9
 - 5/8" X 30" Iron pin w/cap set
 - ⊙ 5/8" X 30" Iron pin w/cap set on line and 30.0' from corner
 - Mag nail set

0809100003
0809100002

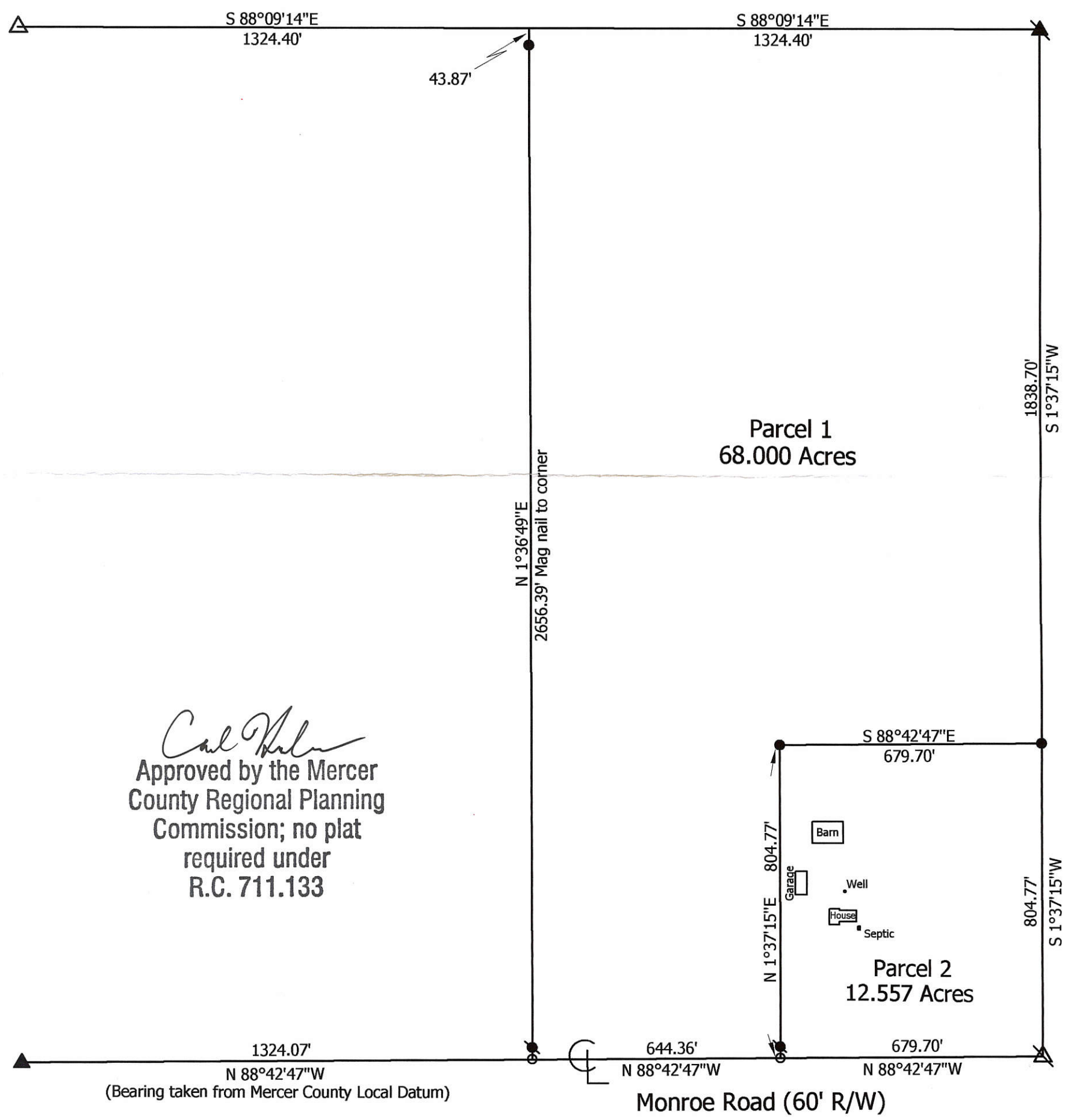

Carl Weber
Approved by the Mercer
County Regional Planning
Commission; no plat
required under
R.C. 711.133

**Marbaugh
Land Surveying**
1901 Carolina Court
Celina, Ohio 45822
(419) 586-4293
Kent Marbaugh
Kent B. Marbaugh P.S.7421



Heyne Survey

State of: Ohio County: Mercer
 Township: Jefferson Sec: 9 Town: 6S Range: 2E
 City/Village: _____ Subdivision: _____ Lot: _____
 Deed References: Vol. 304, Page 724 Date Surveyed: 10-20-08

Approvals: <i>Chi Ma</i>	<i>NA</i>	<i>Lawson Eicher</i>
Agency: Board of Health	Township Zoning Inspector	County Engineer
Date: <u>10-29-08</u>		<u>10-28-08</u>

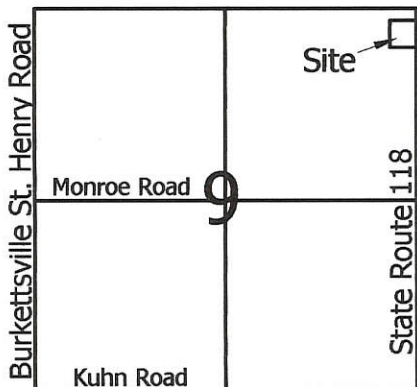

Legend:

- ▲ P.K. nail @ the NE corner of Section 9
- ▲ Iron Pin @ the E1/4 post of Section 9
- Mag nail set
- 5/8" X 30" Iron pin w/cap set
- 5/8" X 30" Iron pin w/cap found (Geeslin)
- ⊗ P.K. nail found (Geeslin)

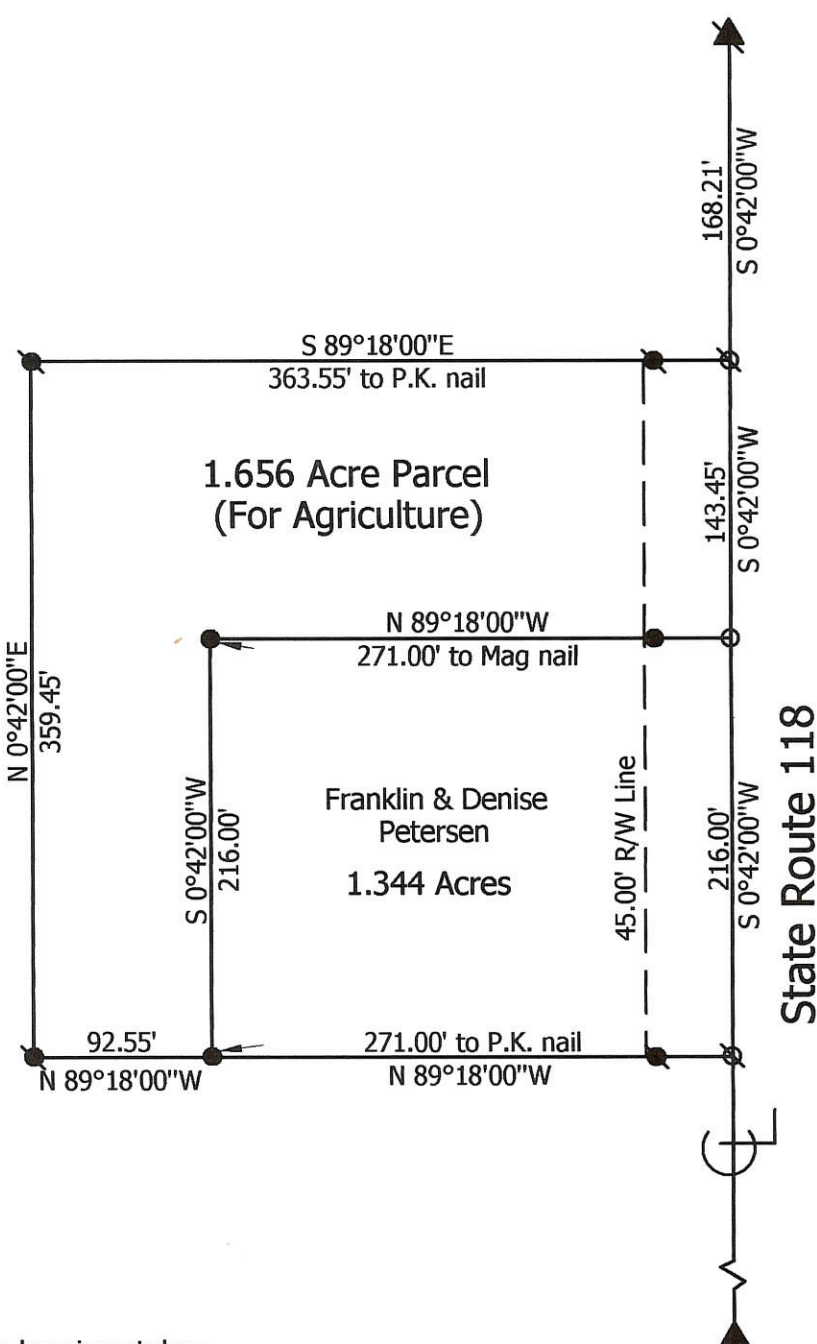
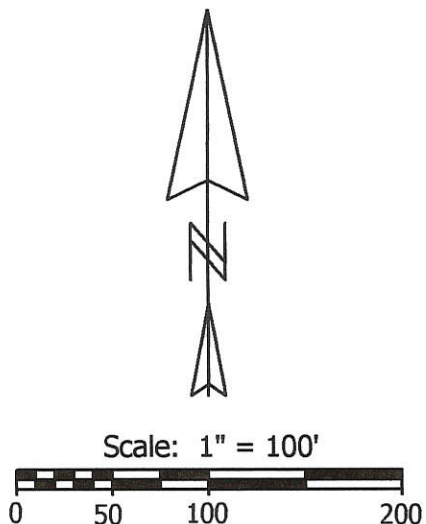

Notes: 1. Reference is made and the bearings taken from a survey by Jim Geeslin dated 1-10-98
 2. Offset pins found & set are all at 40.00'

Marbaugh Land Surveying

1210 Yorkshire Court
 Celina, Ohio 45822
 (419) 586-4293



Kent Marbaugh
 Kent B. Marbaugh P.S.7421

Petersen Survey

State of: Ohio County: Mercer
 Township: Jefferson Sec: 9 Town: 6S Range: 2E
 City/Village: _____ Subdivision: _____ Lot: _____
 Deed Ref: O.R.80 Pg.309 Date Surveyed: 11-7-03

Approvals: _____	_____	_____
Agency: Board of Health	Township Zoning Inspector	County Engineer
Date: _____		

080920003

08-B

LOCATION SKETCH

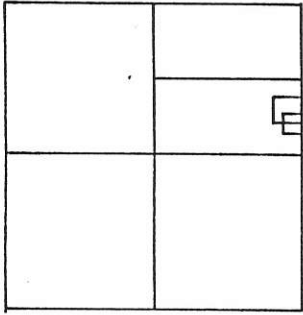

SECTION 9

LEGEND

- "A" = 5/8" IRON BAR @ S.E. COR. ~ N.E. 1/4 ~ SEC. 9.
- "B" = P.K. NAIL FD. @ N.E. COR. ~ SEC. 9.
- o = P.K. NAIL SET.
- = 5/8" IRON BAR SET.

SURVEYED BY *James W. Geeslin*
 JAMES W. GEESLIN
 P.S. 7764

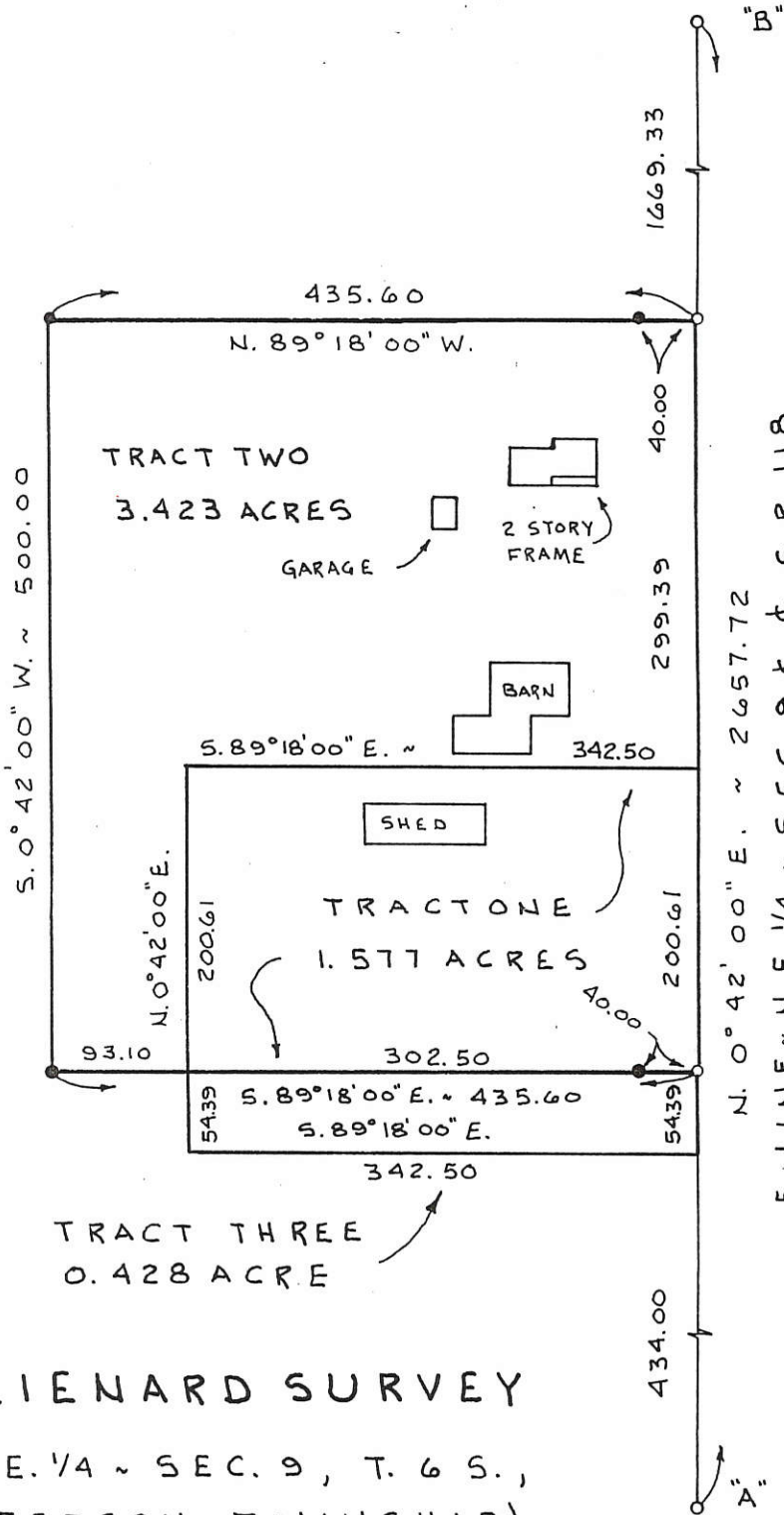

GRANDLIENARD SURVEY

PART ~ S. 1/2 ~ N.E. 1/4 ~ SEC. 9, T. 6 S.,
 R. 2 E., (JEFFERSON TOWNSHIP),
 MERCER COUNTY, OHIO.

OCT. 19, 1998

SCALE 1" = 100'

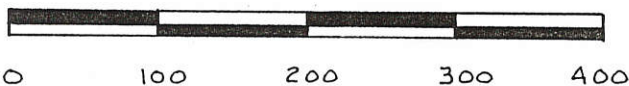

GEESLIN LAND SURVEYING

P. O. BOX 422
 804 EAST MARKET STREET
 CELINA, OHIO
 PHONE (419) 586-6155



PERMANENT PARCEL No. _____

Part of: _____ Sec. _____ T _____ R _____ Township

Grantor: _____ Area Retained: _____ Acres

Grantee: _____ Area Transferred: _____ Acres

Deed References: _____

APPROVALS:

AGENCY: _____ Board of Health

County Sanitary Engineer

County Engineer

DATE: _____

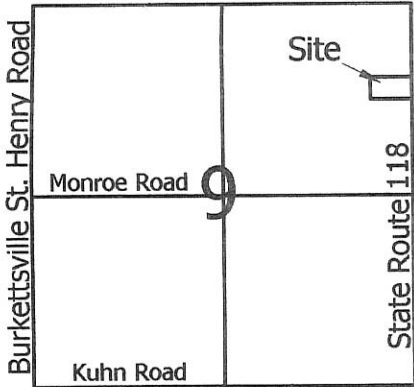

Scale: 1" = 100'

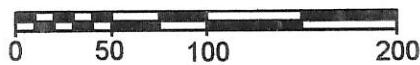

Legend:

- ▲ Cornerstone @ the NE corner of Section 9
- ▲ Cornerstone the E1/4 post of Section 9
- Mag nail set
- 5/8" X 30" Iron pin w/cap set
- 5/8" X 30" Iron pin w/cap found (Geeslin)
- ⊗ Mag nail found (Geeslin)

Parent
 Tax # 26-046800.0100
 Map # 08-09-200-004

Stephen & Virginia Zumberge
 Vol. 45, Pg. 844

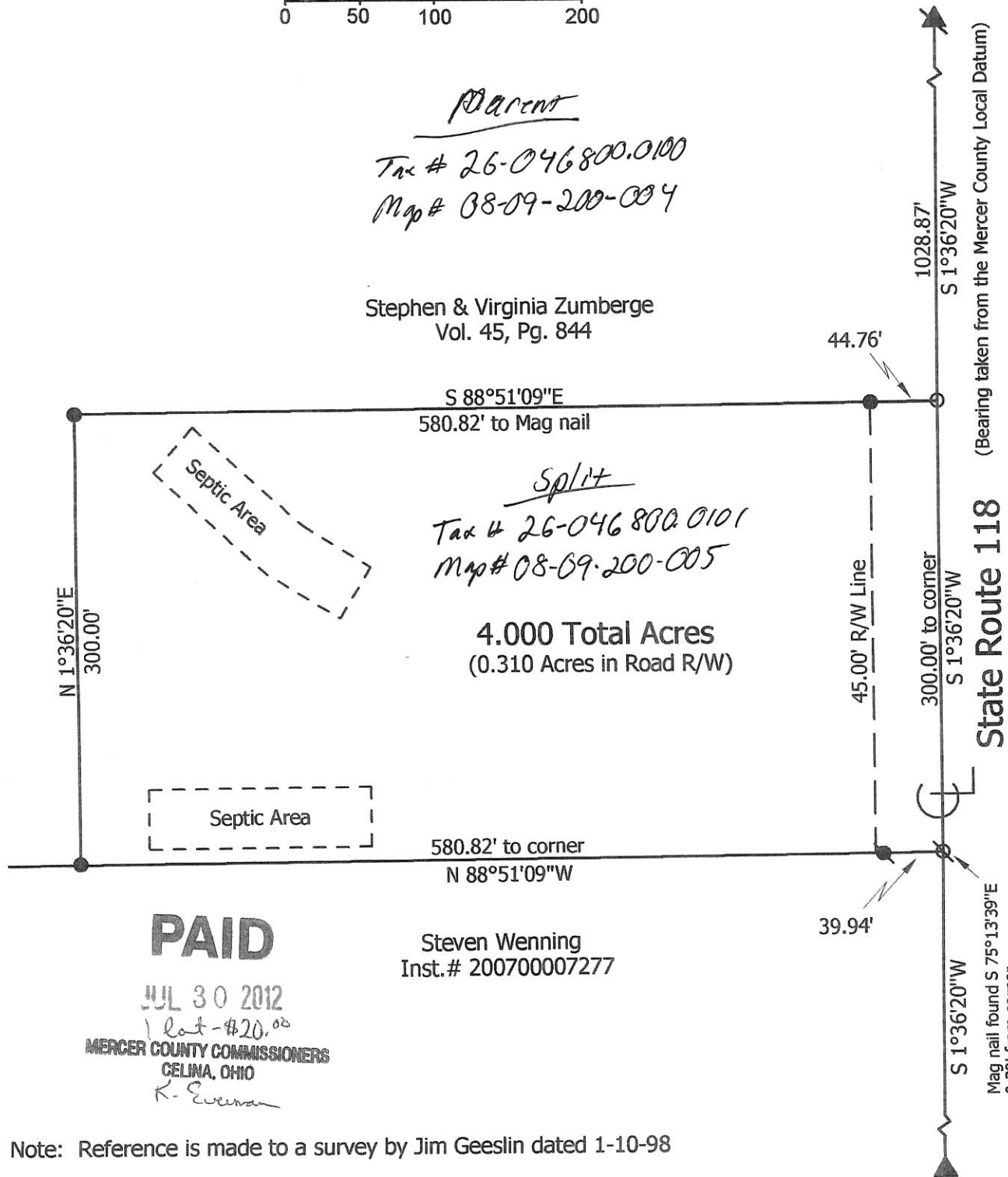

Split
 Tax # 26-046800.0101
 Map # 08-09-200-005

4.000 Total Acres
 (0.310 Acres in Road R/W)

PAID

JUL 30 2012
 1 lot - \$20.⁰⁰
 MERCER COUNTY COMMISSIONERS
 CELINA, OHIO
K. Eversman

Steven Wenning
 Inst. # 200700007277

Note: Reference is made to a survey by Jim Geeslin dated 1-10-98

Marbaugh Land Surveying 1901 Carolina Court Celina, Ohio 45822 (419) 586-4293 <i>Kent Marbaugh</i> Kent B. Marbaugh P.S.7421		Zumberge Survey	
		State of: <u>Ohio</u> County: <u>Mercer</u> Township: <u>Jefferson</u> Sec: <u>9</u> Town: <u>6S</u> Range: <u>2E</u> City/Village: _____ Subdivision: _____ Lot: _____ Deed Ref: <u>Vol. 45, Pg. 844</u> Date Surveyed: <u>6-26-12</u>	Approvals: <i>[Signature]</i> Agency: <u>Board of Health</u> Date: <u>7-13-12</u>

08-B(9)

0809200001
 0809200004
 0809200005

08-B

LOCATION SKETCH

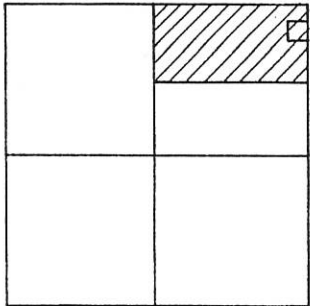

SECTION 9

LEGEND

- "A" = P.K. NAIL FOUND @ N.E. COR. SEC. 9 (SEE CO. REF.)
- "B" = 5/8" IRON BAR FOUND @ E. 1/4 PT. SEC. 9 (" " " ")
- "C" = P.K. NAIL FOUND @ CENTER ~ SEC. 9 (" " " ")
- "D" = 5/8" IRON BAR FOUND @ N. 1/4 PT. ~ SEC. 9 (" " " ")
- = P.K. NAIL SET.
- = 5/8" x 30" IRON BAR SET.

SURVEYED BY James W. Geeslin
 JAMES W. GEESLIN
 P.S. 7764

N. LINE ~ N.E. 1/4 ~ SEC. 9
 S. 89° 54' 53" E. ~ 2637.23

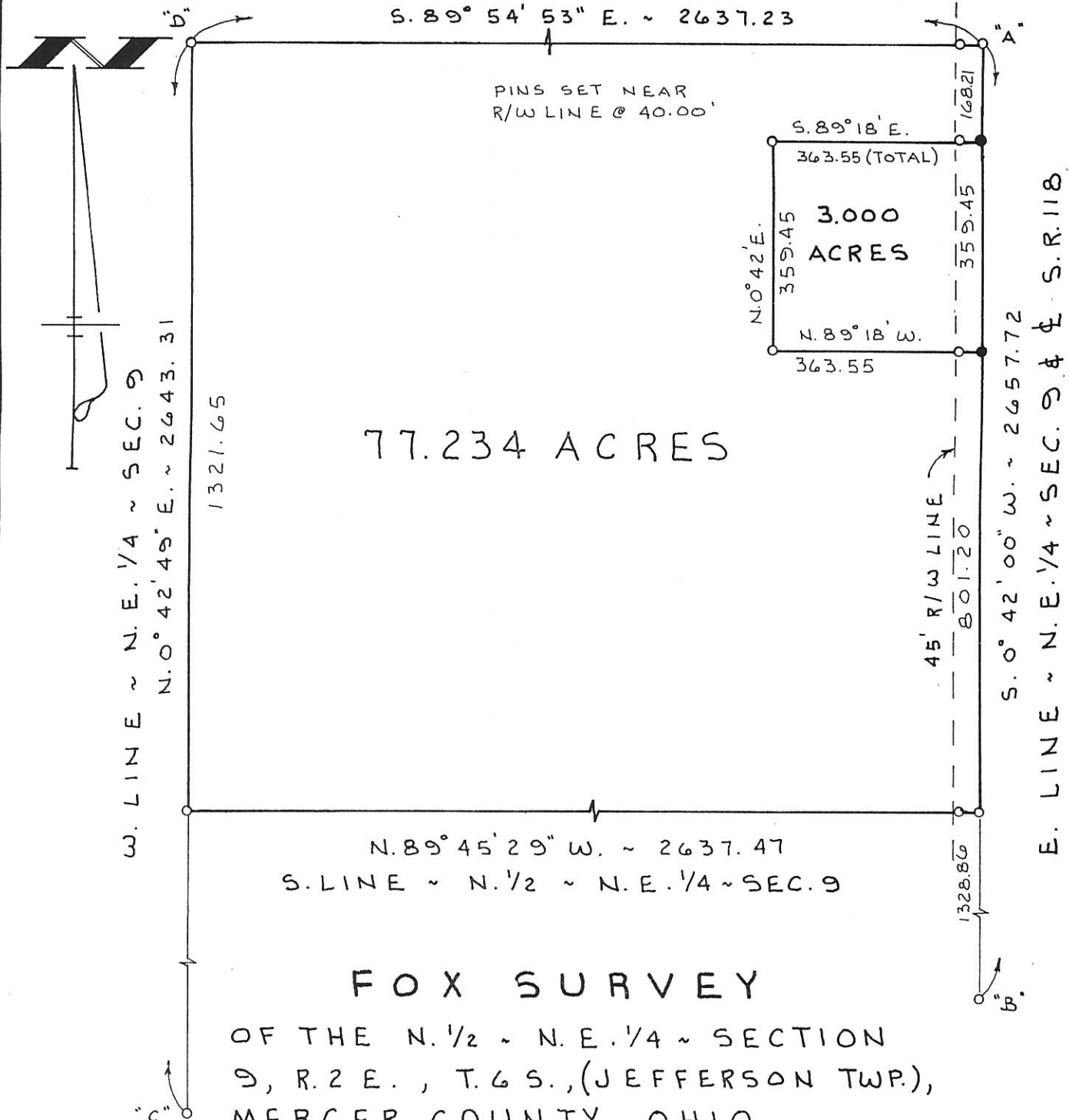

77.234 ACRES

FOX SURVEY
 OF THE N. 1/2 ~ N.E. 1/4 ~ SECTION
 9, R. 2 E., T. 6 S., (JEFFERSON TWP.),
 MERCER COUNTY, OHIO.

JANUARY 10, 1998 SCALE 1" = 200'



**GEESLIN
 LAND SURVEYING**
 P. O. BOX 422
 804 EAST MARKET STREET
 CELINA, OHIO
 PHONE (419) 586-6155



PERMANENT PARCEL No. _____

Part of: _____ Sec. _____ T _____ R _____ Township _____

Grantor: _____ Area Retained: _____ Acres

Grantee: _____ Area Transferred: _____ Acres

Deed References: _____

APPROVALS:

AGENCY: Board of Health	County Sanitary Engineer	County Engineer
DATE: _____		

0809300002

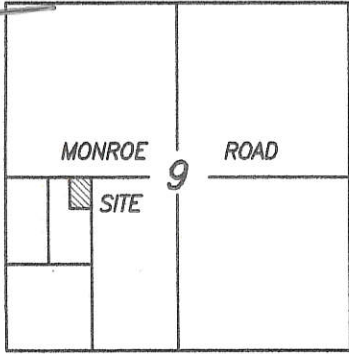

9 SECTION 6 S TOWNSHIP 2 E RANGE
JEFFERSON CIVIL TOWNSHIP MERCER COUNTY OHIO STATE

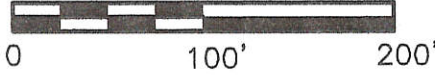

SCALE 1"=100'

LEGEND

- IRON PIN SET #5 REBAR ±30" LONG W/ SURVEYOR CAP
- ⊙ IRON SPIKE SET
- ⊗ P.K. NAIL FD.
- ⊙ IRON SPIKE FOUND
- () CALLED DIMENSION

SURVEY REFERENCE

- 1) MERCER COUNTY LOCAL COORDINATE DATUM

MONROE ROAD 60' RW

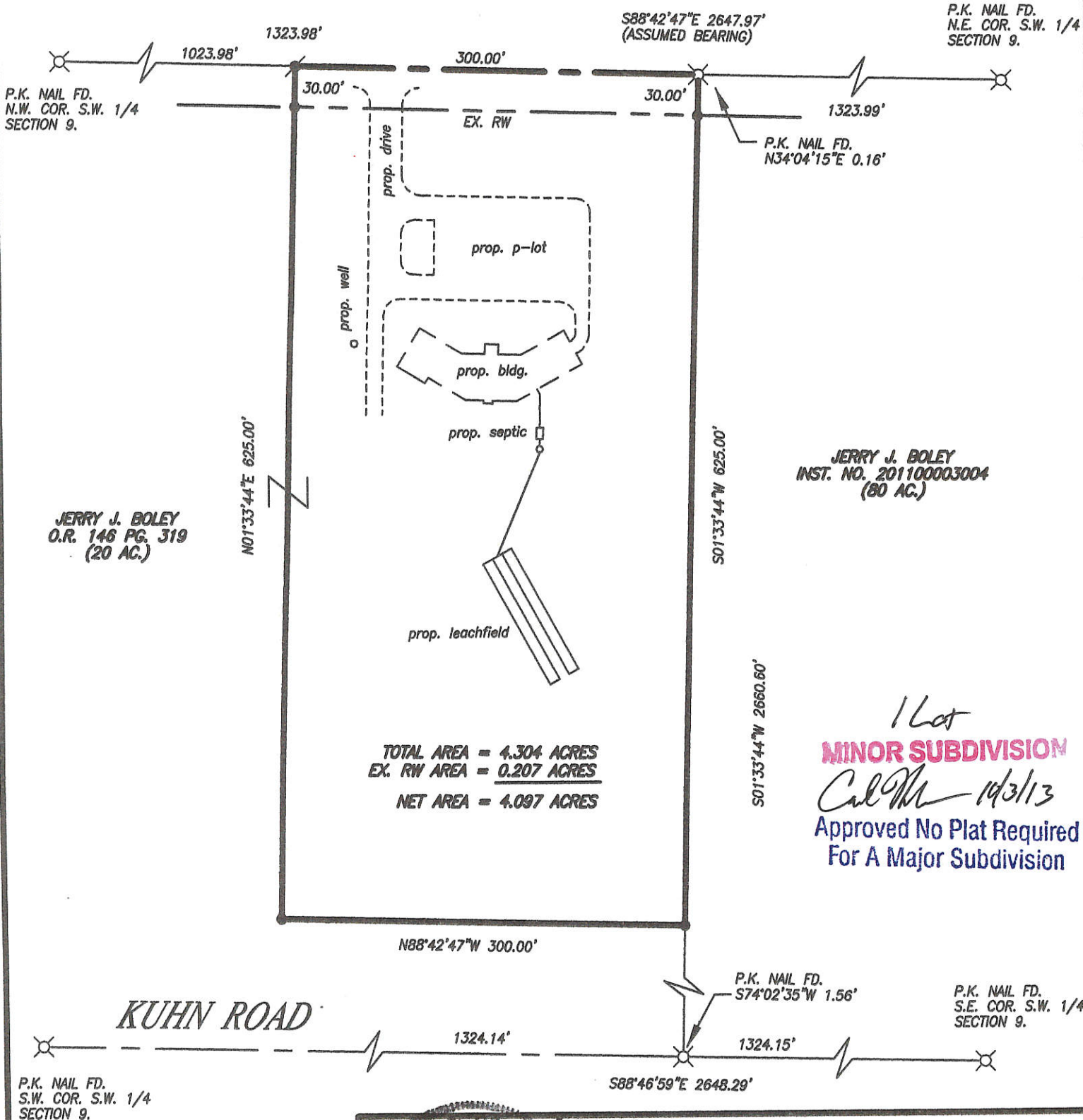

P.K. NAIL FD. S.W. COR. S.W. 1/4 SECTION 9.

SURVEYED BY

Louis J. Bergman
LOUIS J. BERGMAN
REG. SURVEYOR #7177

DATE: 9-9-13

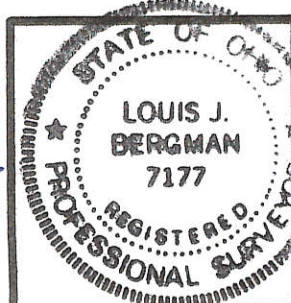

PERMANENT PARCEL NO.			
PART OF:	S.W. 1/4	SEC. 9	T 6-S R 2-E JEFFERSON TOWNSHIP
GRANTOR:	AREA RETAINED: _____ ACRES		
GRANTEE:	AREA TRANSFERRED: _____ ACRES		
DEED REFERENCES:	O.R. 146 PG. 319		
APPROVALS:	<i>Chris</i>	N/A	<i>Van Eiden</i>
AGENCY:	Board of Health	Co. Sanitary Engineer	County Engineer
DATE:	10-2-13		9-27-13

A: 0809300003
B: 0809300004

LOCATION SKETCH

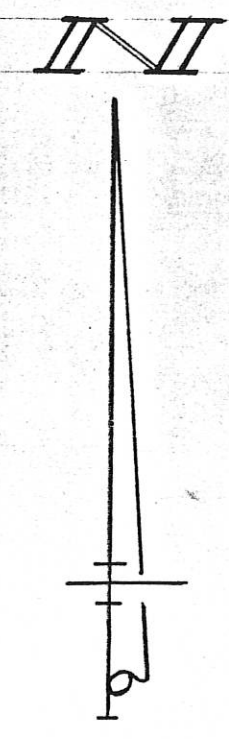
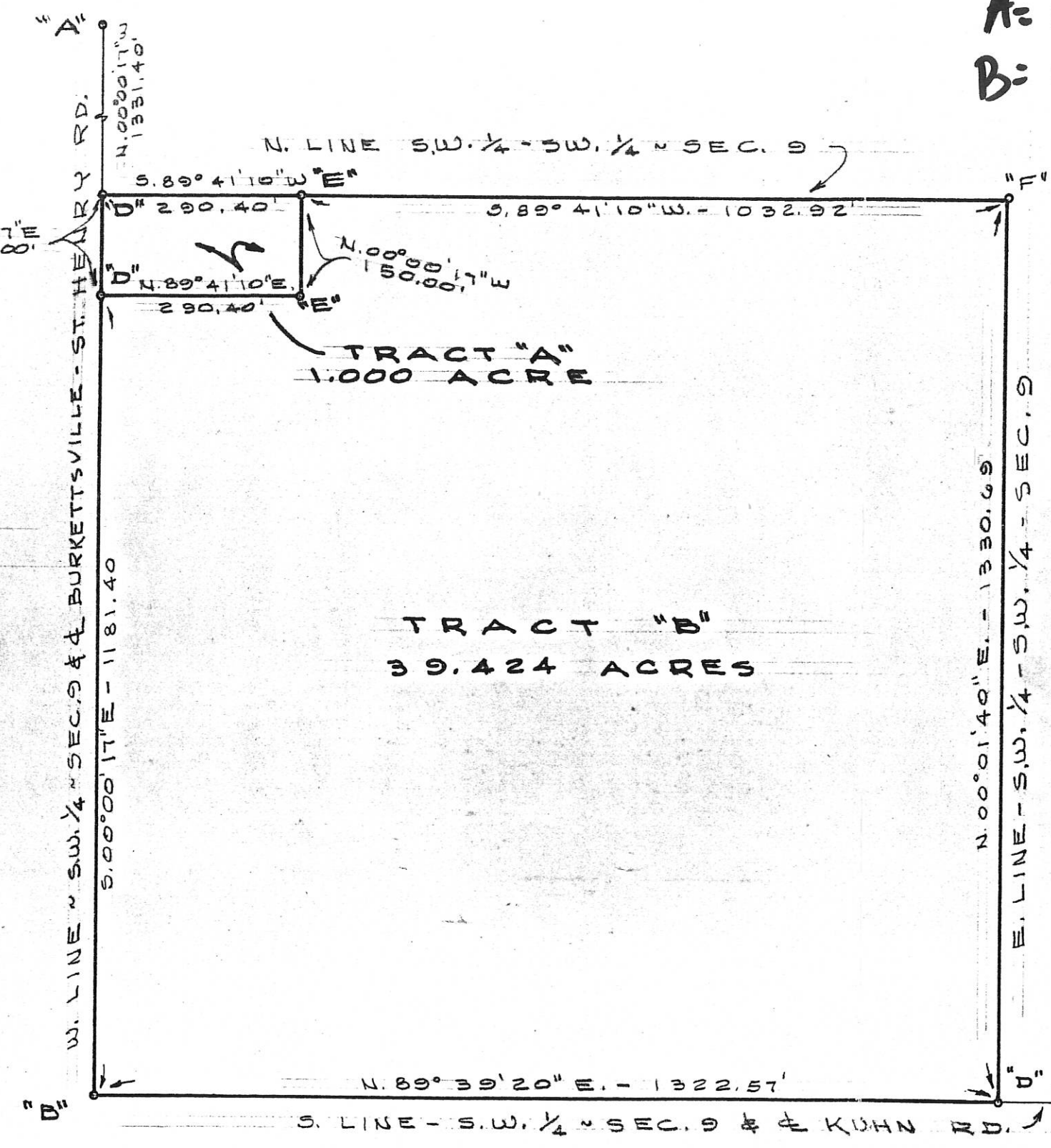
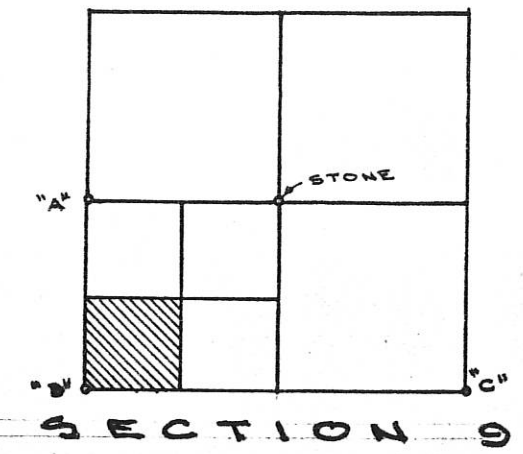

LEGEND

- "A" = STONE FD. @ N.W. COR. - S.W. 1/4 - SEC. 9.
- "B" = STONE FD. @ S.W. COR. - SEC. 9.
- "C" = STONE @ S.E. COR. - SEC. 9.
- "D" = BOAT SPIKE SET.
- "E" = 5/8" IRON BAR SET.
- "F" = WOOD CORNER POST.

NOTE

REFERENCE IS MADE TO A SURVEY OF SECTION 9 BY MARCUS SCHUYLER DATED JAN. 26, 1871, FOUND IN SURVEY BOOK 2, PAGE 53

SURVEYED BY Gordon L. Geeslin
GORDON L. GEESLIN
REGISTERED SURVEYOR
No 5372
CELINA, OHIO

ANDREW SURVEY OF THE S.W. 1/4 OF THE S.W. 1/4 OF SECTION 9, TOWN 6 SOUTH, RANGE 2 EAST (JEFFERSON TWP.), MERCER COUNTY, OHIO.
FEBRUARY 9, 1985 SCALE 1" = 200'

SURVEY OF A 1.125 AC. TRACT FOR KEVIN A. PEASE
LOCATED IN THE S.W. 1/4 OF SEC. 09, T-6-S, R-2-E,
JEFFERSON TWP., MERCER COUNTY, STATE OF OHIO

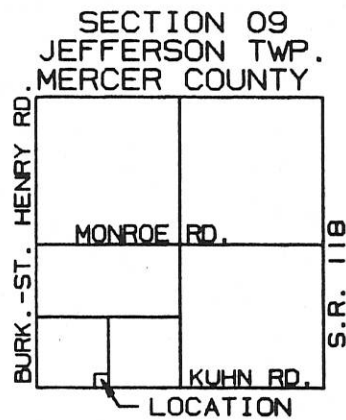

KEVIN A. PEASE

Vol. 295, Pg. 827

L. BAUCHERG
VOL. 210, PG. 35

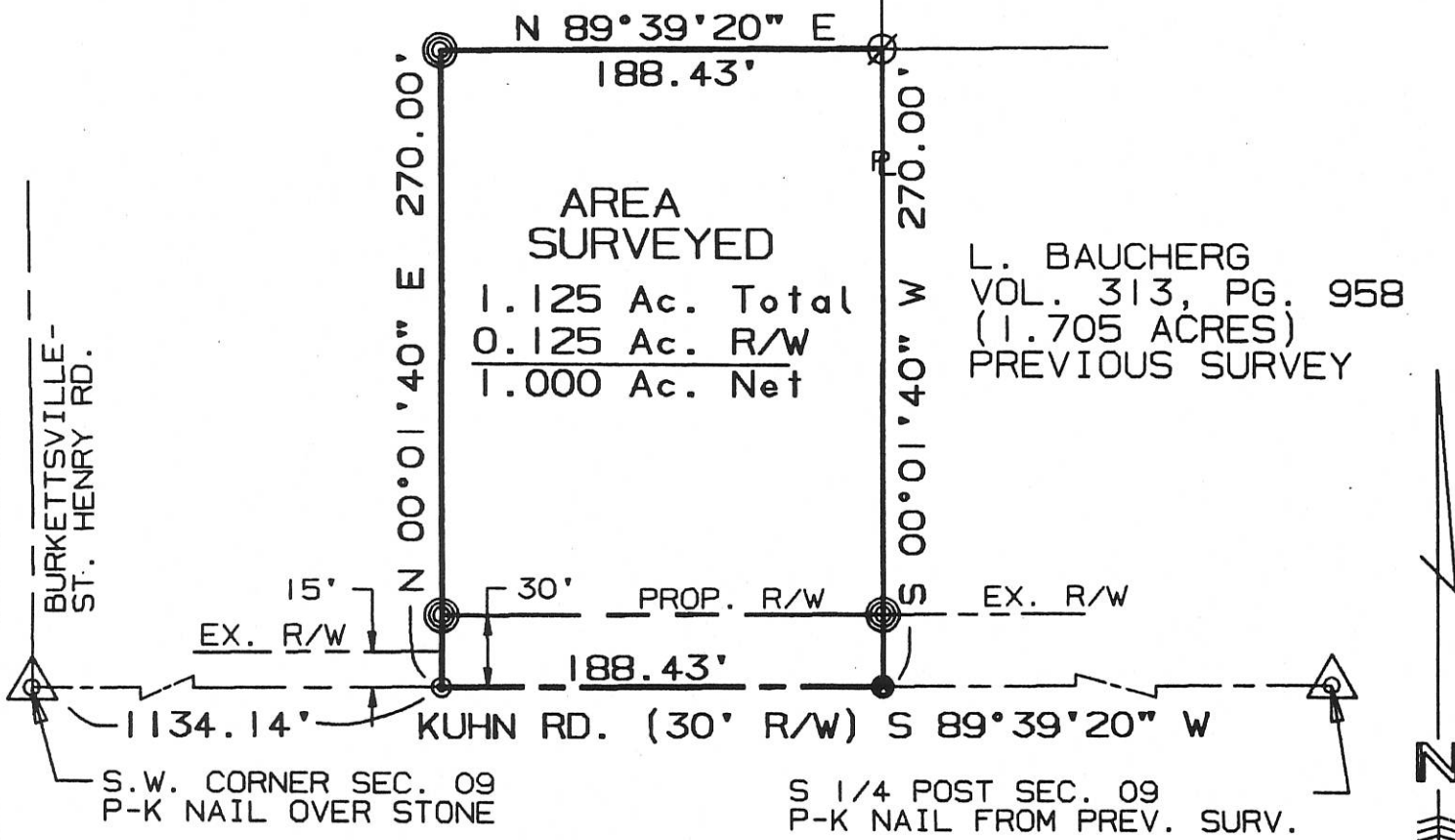

L. BAUCHERG
VOL. 313, PG. 958
(1.705 ACRES)
PREVIOUS SURVEY



SURVEYED BY: Eric C. Thomas
ERIC C THOMAS REG. SURVEYOR #7236
DATE: 08-29-97

- ⊗ = SPIKE FOUND
- ∅ = I. PIN FOUND
- ⊙ = I. PIN SET
- ⊙ = P.K. NAIL SET

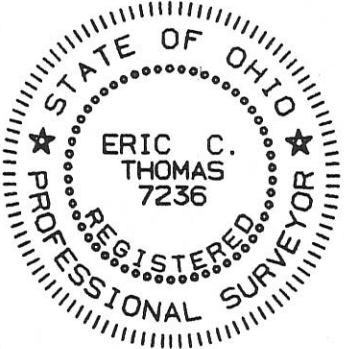

References: PREVIOUS SURVEY OF THIS TRACT (39.424 ACRES) BY GORDON L. GEESLIN REG SURV. #5372 DATED 02-09-85

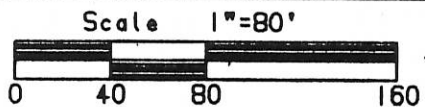

Part of S.W. 1/4 Sec. 09 T6-S R2-E Jefferson Twp., MERCER Co., OHIO
GRANTOR: K. PEASE DEEDS: Vol. 295 Pg. 827 AREA RETAINED ____ Ac.
GRANTEE: _____ AREA: 1.125 Ac.

APPROVALS:	_____	_____	_____	_____
AGENCY:	BD. OF HEALTH	Co. San. Eng.	Co. Engineer	PERMANENT PARCEL No.
DATE				

0809300007

08-B

LEGEND

- △ = CORNERSTONE (REFER TO MERCER COUNTY STONE RECORDS).
- = 5/8 INCH IRON BAR FOUND.
- ⊙ = MAG NAIL SET.
- ⊙ = 5/8 INCH IRON BAR SET.

BAUCHER SURVEY

PART OF THE S.W. 1/4 - SEC. 9, TOWN 6 SOUTH, RANGE 2 EAST,
(JEFFERSON TOWNSHIP), MERCER COUNTY, OHIO.

JULY 16, 2007

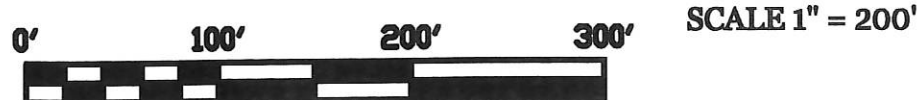

LOCATION SKETCH

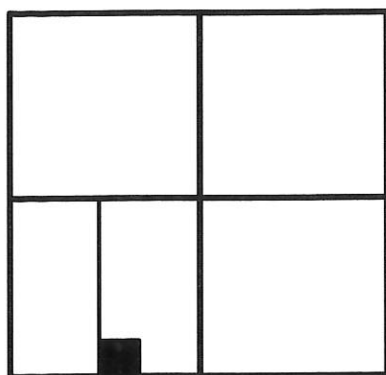

SECTION 9

KERRY & LORI PEASE
1.125 ACRES
O.R. 37 PG. 455

W. LINE - E. 1/2 - S.W. 1/4 SEC. 9

S 89°22'01" W 475.83'

POND

SURVEY REFERENCE: BAUCHER SURVEY BY G.
GEESLIN, P.S. 5372, DATED JULY 7, 1989.

LESTER & FLORENCE BAUCHER
80.00 ACRES BY DEED
O.R. 152 PG. 2553

S 00°01'40" W 590.73' (T)

6.432 TOTAL ACRES
(0.216 AC. IN R/W)

EXISTING
SEPTIC
TANK

6.216 AC. NET

WELL

N 00°30'13" E 593.18' (T)



10.00'

20' R/W LINE

470.88'

10.00'

1322.57'

N 89°39'20" E 5285.00'

3491.55'

S.W. COR. -
SEC. 9

S. LINE - SEC. 9 & $\frac{1}{2}$ KUHN RD. (40' R/W)

S.E. COR. -
SEC. 9

SURVEYED BY

James W. Geeslin
JAMES W. GEESLIN
 P.S. No. 7764

PERMANENT
PARCEL No.

Part of: Sec. T R Township
Grantor: Area Retained: Acres

Grantee: Area Transferred: Acres

Deed References:

APPROVALS:
AGENCY:
DATE:

Board of Health

Township Zoning Officer

County Engineer



GEESLIN
LAND SURVEYING

107 N. CEDAR ST.
COLDWATER, OHIO 45828
PHONE (419) 586-6155
FAX (419) 678-9332

LEGEND

- "A" = STONE NO 1115 AT S.W. COR. OF SECTION 9.
- "B" = STONE AT S.E. COR. ~ SEC. 9.
- "C" = BOAT SPIKE FD. AT SW. COR. ~ E. 1/2 ~ S.W. 1/4 ~ SEC. 9.
- "D" = MINE SPIKE SET.
- "E" = 5/8" X 30" IRON BAR SET.

LOCATION SKETCH

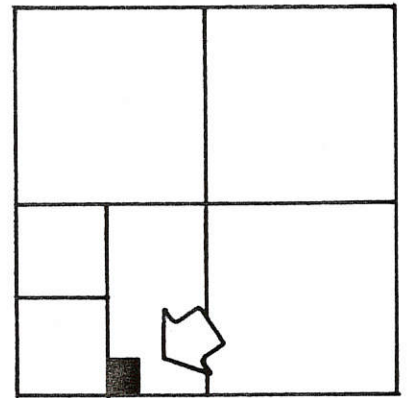

SECTION 9

PRIOR OWNERSHIP RECORDED IN DEED VOL. 210, PG. 35

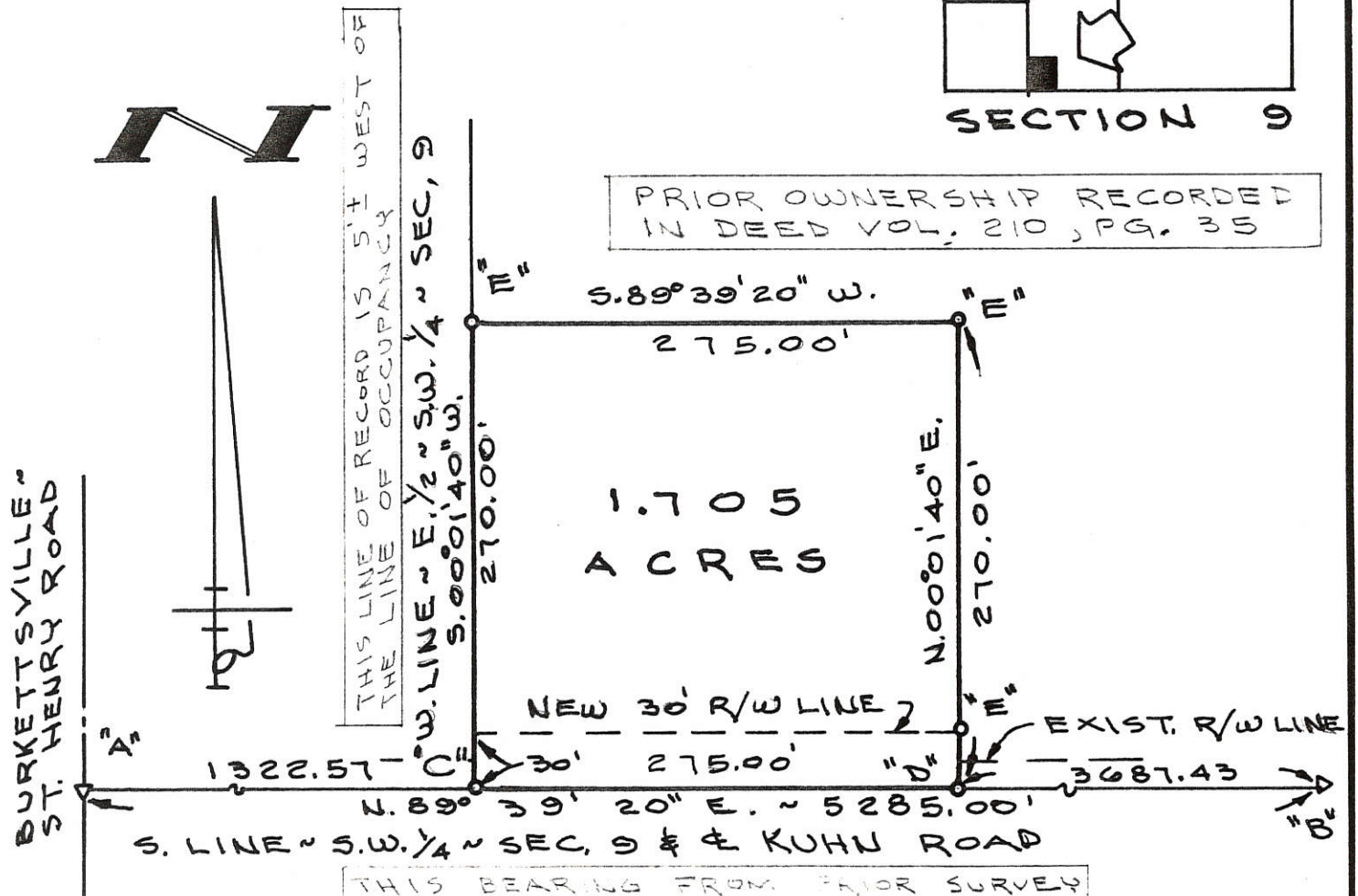

SURVEYED BY Gordon L. Geeslin
 GORDON L. GEESLIN
 REGISTERED SURVEYOR
 NO 5372

FILED IN SURVEY BOOK

BAUCHER SURVEY
 PART OF THE E. 1/2 OF THE S.W. 1/4 OF SEC. 9, TOWN 6 SOUTH, RANGE 2 EAST (JEFFERSON TWP.), MERCER COUNTY, OHIO.
 JULY 7, 1989 SCALE 1"=100'

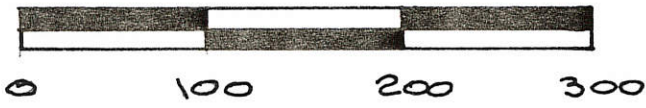

GORDON L. GEESLIN
 LAND SURVEYOR
 810 EAST MARKET STREET
 CELINA, OHIO
 PHONE (419) 586-6155



PERMANENT PARCEL No. _____

Part of: _____ Sec. _____ T _____ R _____ Township

Grantor: _____ Area Retained: _____ Acres

Grantee: _____ Area Transferred: _____ Acres

Deed References: _____

APPROVALS:
 AGENCY: _____ DATE: _____

Board of Health _____ County Sanitary Engineer _____ County Engineer _____

LOCATION SKETCH

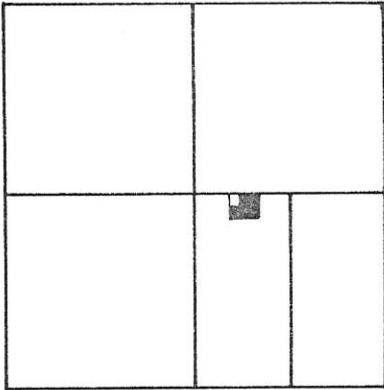

LEGEND

- "A" = P.K. NAIL OVER COR. STONE @ THE CENTER ~ SEC. 9.
- "B" = 5/8" IRON BAR OVER COR. STONE @ THE E. 1/4 POST ~ SEC. 9
- = P.K. NAIL SET.
- = 5/8" IRON BAR SET.

SECTION 9

N. LINE ~ S.E. 1/4 ~ SEC. 9 & MONROE RD.

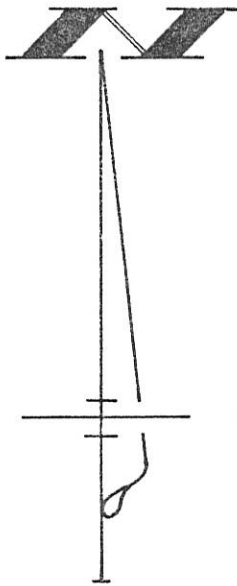
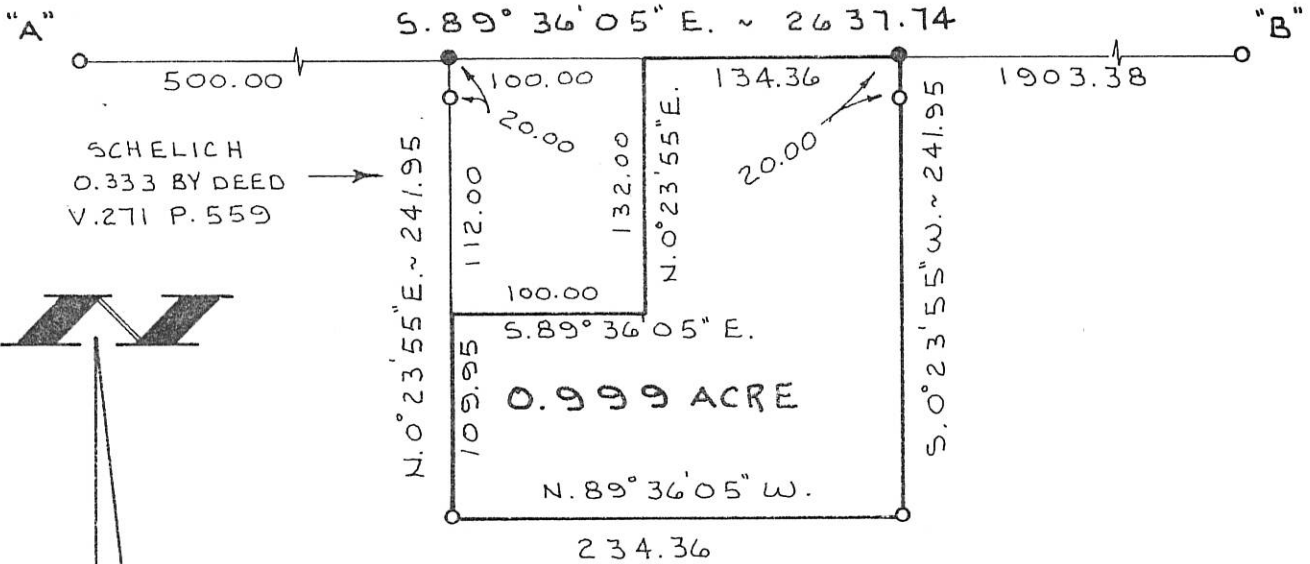

SURVEYED BY James W. Geeslin
JAMES W. GEESLIN
P.S. 7764

SCHELICH SURVEY

PART ~ W. 1/2 ~ S.E. 1/4 ~ SECTION 9,
(JEFFERSON TWP.), T. 6 S., R. 2 E., MERCER
COUNTY, OHIO.

JANUARY 15, 1998

SCALE 1" = 100'

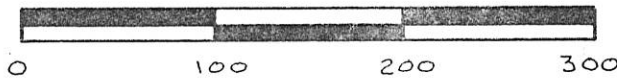

GEESLIN
LAND SURVEYING

810 EAST MARKET STREET
CELINA, OHIO
PHONE (419) 586-6155

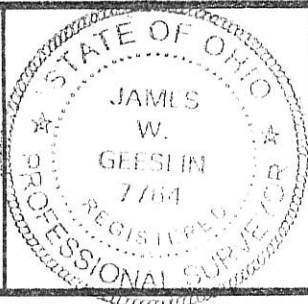

PERMANENT PARCEL No. _____

Part of: _____ Sec. _____ T. _____ R. _____ Township

Grantor: _____ Area Retained: _____ Acres

Grantee: _____ Area Transferred: _____ Acres

Deed References: _____

APPROVALS

AGENCY	Board of Health	County Sanitary Engineer	County Engineer
DATE			

08-B ✓

SURVEY OF A 4.055 ACRE PARCEL FOR LAVERN HEUING
LOCATED IN THE S.E. 1/4 OF SEC. 9, T-6-S,
R-2-E, JEFFERSON TWP., MERCER CO., OHIO

0809400012

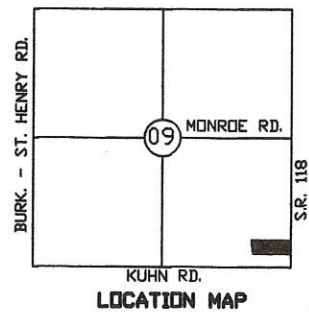
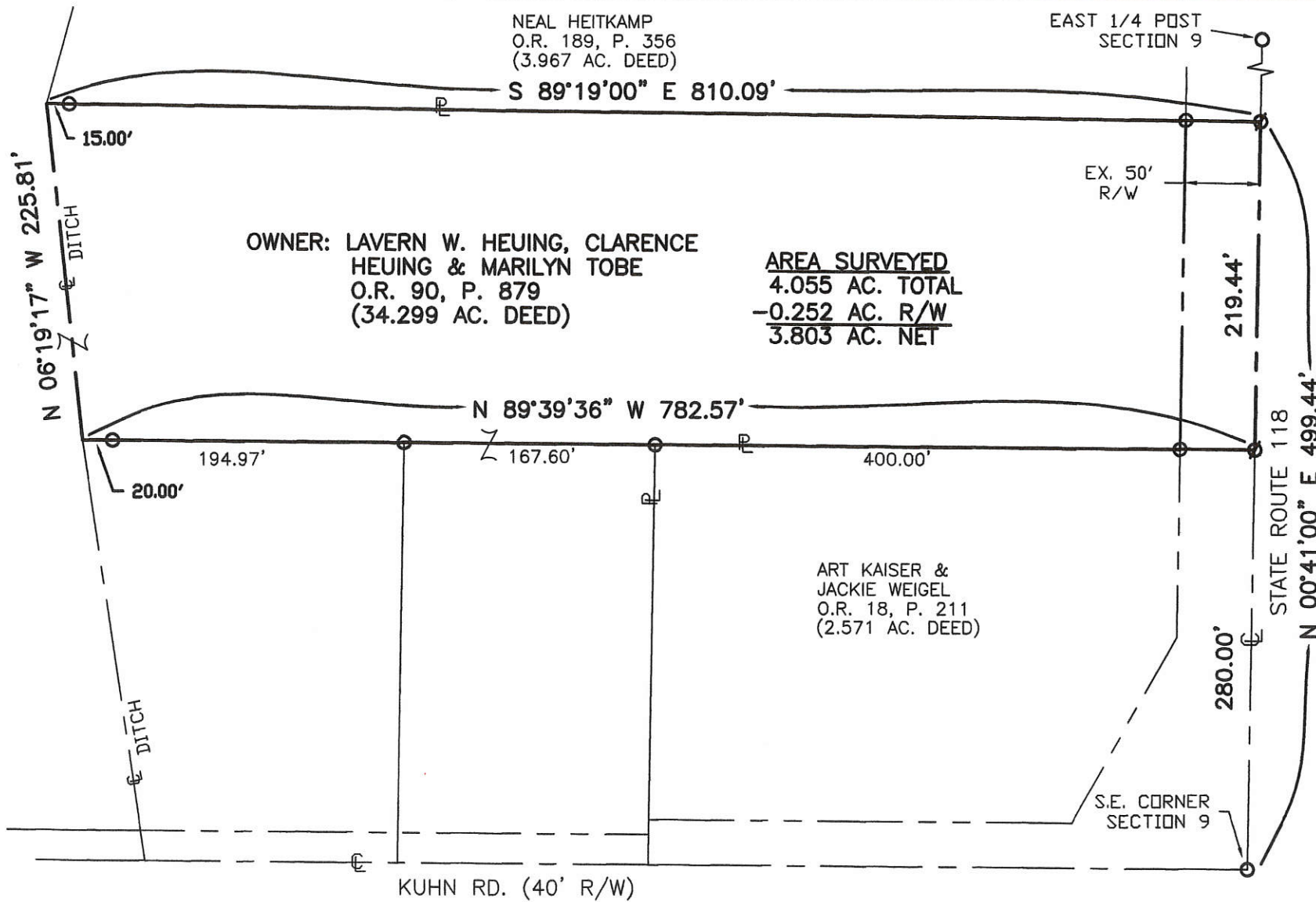

LEGEND

- Iron Pin Found
- Iron Pin Set
- ⊙ P.K. Nail Found
- ⊗ P.K. Nail Set

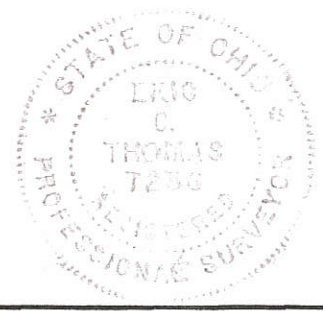

Surveyed By: Eric C. Thomas
Eric C. Thomas Reg. Surveyor No. 7236
Date: 11-21-05

References: PREVIOUS SURVEY OF THE AREA BY THIS SURVEYOR		Scale: 1"= 100'	
Part of S.E. 1/4 Sec. 9 T. 6-S R. 2-E JEFFERSON Twp., Mercer Co., OH			
Grantor: _____		Deeds: _____ Area Retained _____ Ac.	
Grantee: _____		Area _____ Ac.	
Approvals: _____	Agency: Bd. of Health	Co. San. Eng	Co. Engineer
Date: _____			Permanent Parcel No. _____

SURVEY FOR DENNIS & MARY DUES

BEING A PARCEL OF LAND LOCATED IN THE NORTHEAST QUARTER OF THE SOUTHEAST QUARTER OF SECTION 9, W. JEFFERSON TOWNSHIP, TOWN 6 SOUTH, RANGE 2 EAST, MERCER COUNTY, OHIO

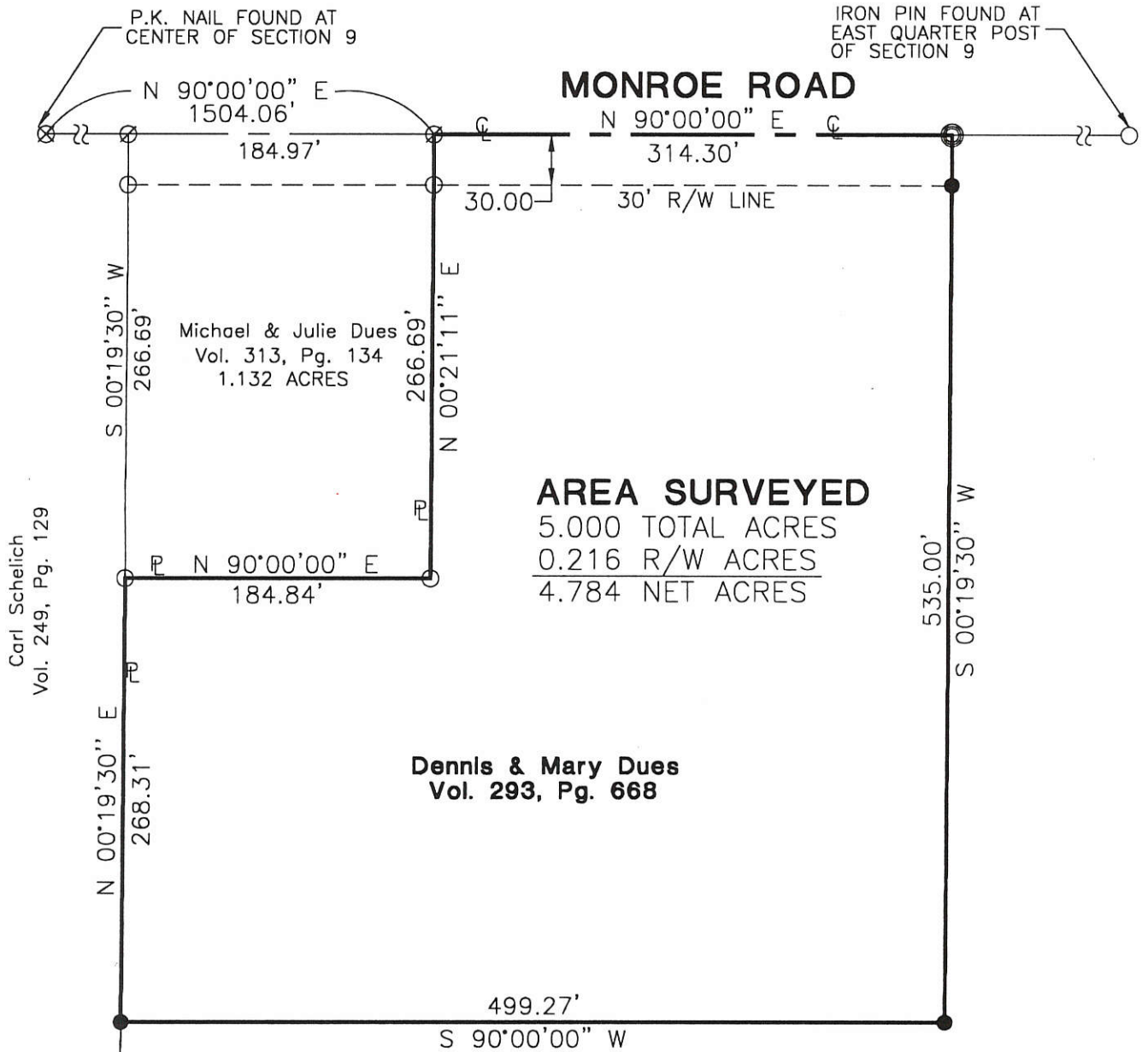

Carl Schelich
Vol. 249, Pg. 129

Dennis & Mary Dues
Vol. 293, Pg. 668

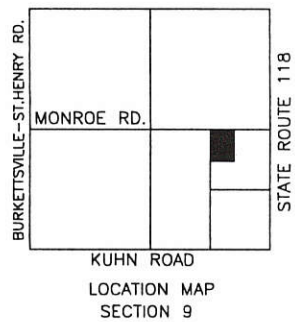

- Iron Pin Found
- Iron Pin Set
- ⊙ P.K. Nail Set
- ⊗ P.K. Nail Found
- ∅ RR Spike Found

Surveyed By: *Eric C. Thomas*
Eric C. Thomas Reg. Surveyor No. 7236
Date: 11-9-99

References: Bearings from the Previous Survey by Roy F. Thompson, Jr. Reg. Surveyor No. 5379	Scale: 1" = 100'
--	----------------------

Part of S.E. 1/4 Sec. 9 T 6-S R 2-E JEFFERSON Twp., Mercer Co., OH
 Grantor: _____ Deeds: _____ Area Retained _____ Ac.
 Grantee: _____ Area _____ Ac.

Approvals: _____ Agency: Bd. of Health Date: _____	Co. San. Eng _____	Co. Engineer _____	Permanent Parcel No. _____
--	--------------------	--------------------	----------------------------

DUES SURVEY
PART SE 1/4, SEC 9, T 6 S, R 2 E, W. JEFFERSON TWP.
MERCER CO, OHIO

08-B
08-09-400-003

LOCATION PLAT

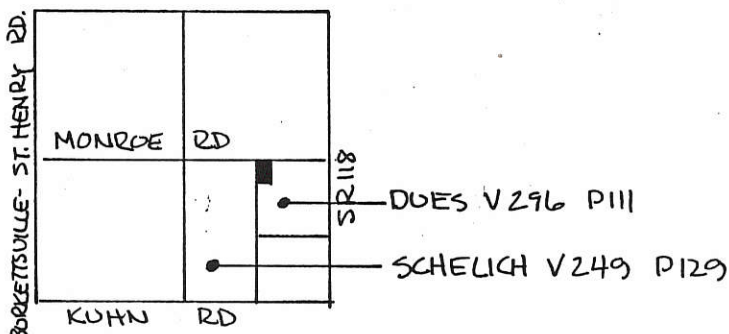

SEC. 9, W. JEFFERSON TWP.

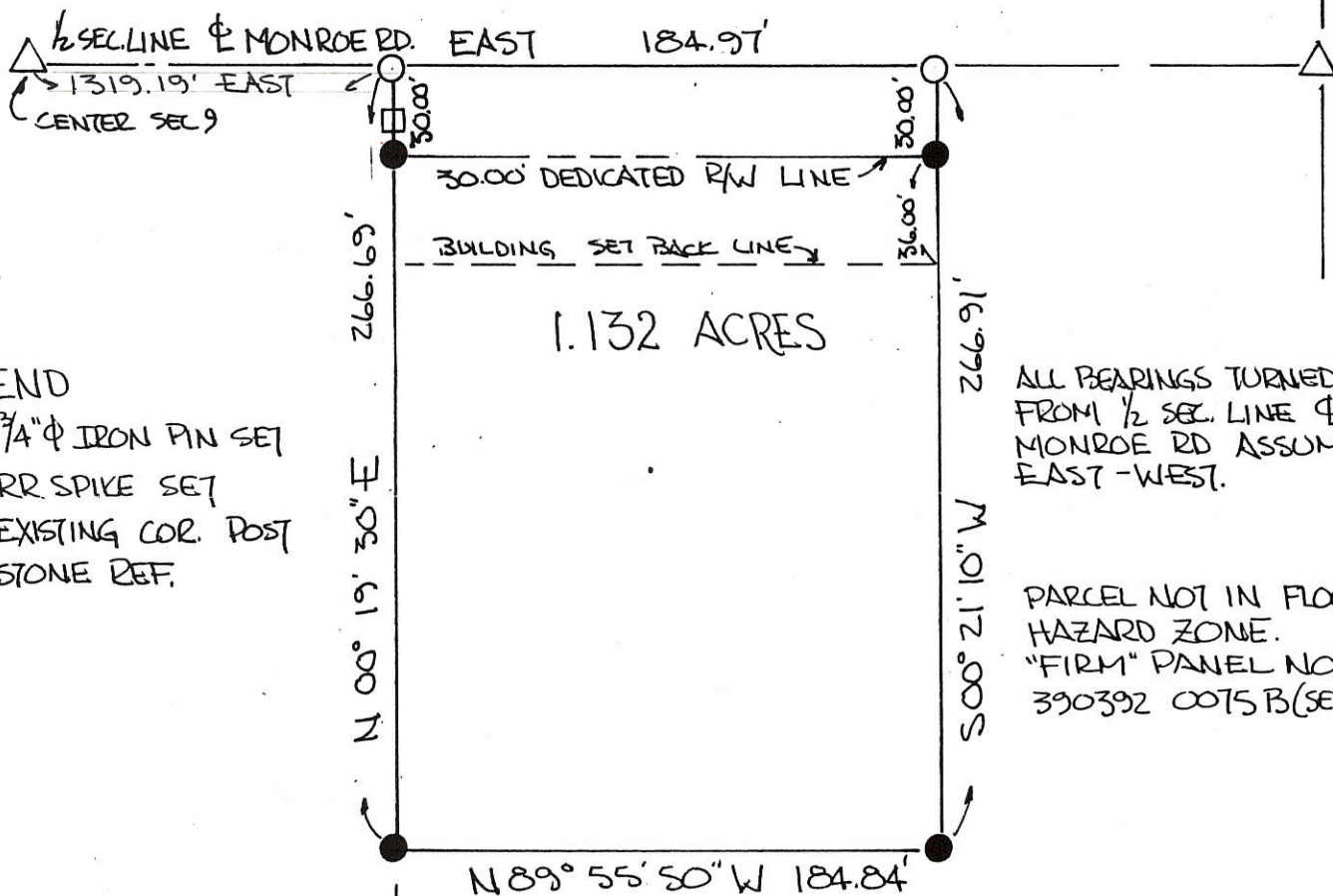

LEGEND

- 3/4" φ IRON PIN SET
- ORR SPIKE SET
- EXISTING COR. POST
- △ STONE REF.

ALL BEARINGS TURNED FROM 1/2 SEC. LINE φ MONROE RD ASSUMED EAST-WEST.

PARCEL NOT IN FLOOD HAZARD ZONE.
"FIRM" PANEL NO 390392 0075 B (SEPT '89)

THE GRANTORS DEDICATE ADDITIONAL LAND SOUTH OF & ADJACENT TO THE EXISTING RIGHT OF WAY OF THE MONROE ROAD TO CREATE A THIRTY (30.00) FOOT RIGHT OF WAY ALONG THIS PARCEL.

Dennis A. Dues 3/21/90
DENNIS A. DUES, GRANTOR DATE
Mary L. Dues 3/21/90
MARY L. DUES GRANTOR DATE

□ 30. LINE SEC 9

PLAT BY SURVEY MARCH 1990

Roy F. Thompson Jr.
ROY F THOMPSON JR
REG. SUR. # 5379



PERMANENT PARCEL No.			
Part of:	SE 1/4	Sec. 9	T 6 S R 2 E WEST JEFFERSON Township
Grantor:	DUES	Area Retained:	37.368 Acres
Grantee:	DUES	Area Transferred:	1.132 Acres
Deed References:	V 296 P 111		
APPROVALS:	<u>Alan W. Gaden</u>	Co. Sanitary Engineer	<u>John P. Gaden</u> County Engineer
AGENCY:	Board of Health		
DATE:	19 MAR 1990		3-19-90

Original Signatures

FILED IN SURVEY BOOK
0809400005

088

SURVEYED BY Barton & Myers
 GORDON L. GEESLIN
 REGISTERED SURVEYOR
 NO. 5372
 CELINA, OHIO



LOCATION SKETCH

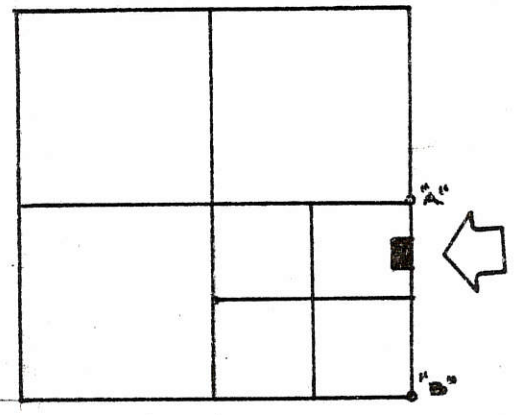

SECTION 9

LEGEND

- "A" = STONE @ N.E. COR. & S.E. 1/4 SECTION 9.
- "B" = STONE @ S.E. COR. & SEC. 9
- "C" = RAILROAD SPIKE SET.
- "D" = 5/8" X 30" IRON BAR SET.

II II

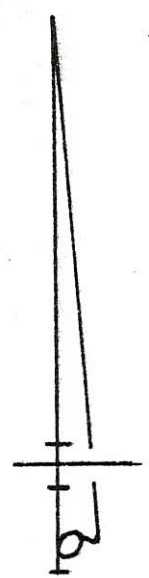

CO. 200R

KREMER SURVEY
 PART OF THE N.E. 1/4 OF THE S.E. 1/4 OF SECTION 9, TOWNSHIP 6 SOUTH, RANGE 2 EAST (JEFFERSON TWP.), MERCER COUNTY, OHIO.

APRIL 22, 1985

SCALE 1" = 100'

**SURVEY OF A 17.371 ACRE PARCEL OF LAND FOR
LAVERN HEUING, CLARENCE HEUING, & MARILYN TOBE**
LOCATED IN THE S.E. 1/4 OF SEC. 9, T-6-S,
R-2-E, JEFFERSON TWP., MERCER CO., OHIO

0809400007

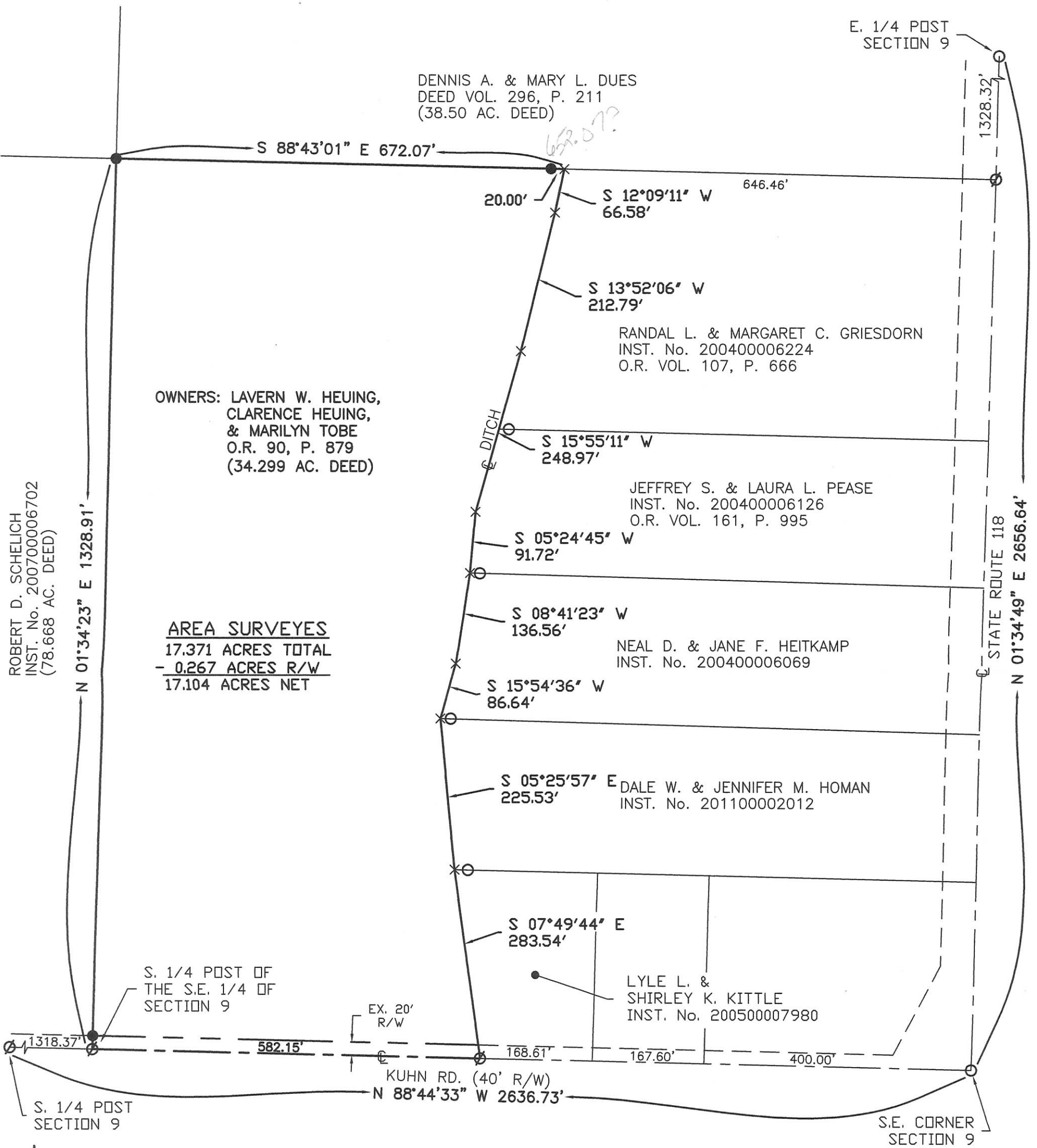

LEGEND

- Iron Pin Found
- Iron Pin Set
- ∅ P.K. Nail Found

Surveyed By: *Eric C. Thomas*
Eric C. Thomas Reg. Surveyor No. 7236
Date: 8-6-11

References: PREVIOUS SURVEYS OF THE AREA BY ERIC C. THOMAS, REG. SUR. No. 7236 & CRAIG W. MESCHER, REG. SUR. No. 8237		Scale: 1" = 150' 	
Part of S.E. 1/4 Sec. 9 T. 6-S R. 2-E JEFFERSON Twp., Mercer Co., OH			
Grantor: _____		Deeds: _____ Area Retained _____ Ac.	
Grantee: _____		Area _____ Ac.	
Approvals: Agency: Bd. of Health	Twp. Zoning Officer	Co. Engineer	Permanent Parcel No.
Date: _____			

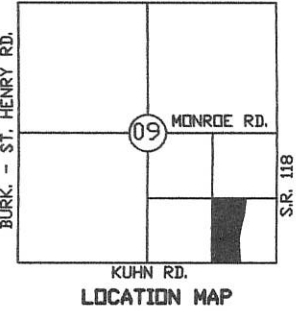

SURVEY FOR LAVERN W. HEUING ETAL

BEING A PARCEL OF LAND LOCATED IN THE SOUTHEAST QUARTER OF THE SOUTHEAST QUARTER OF SECTION 9, JEFFERSON TOWNSHIP, TOWN 6 SOUTH, RANGE 2 EAST, MERCER COUNTY, OHIO

MICHAEL D & JULIE R DUES EAST 1/4 POST OF SEC. 9
O.R. 99, PG. 242

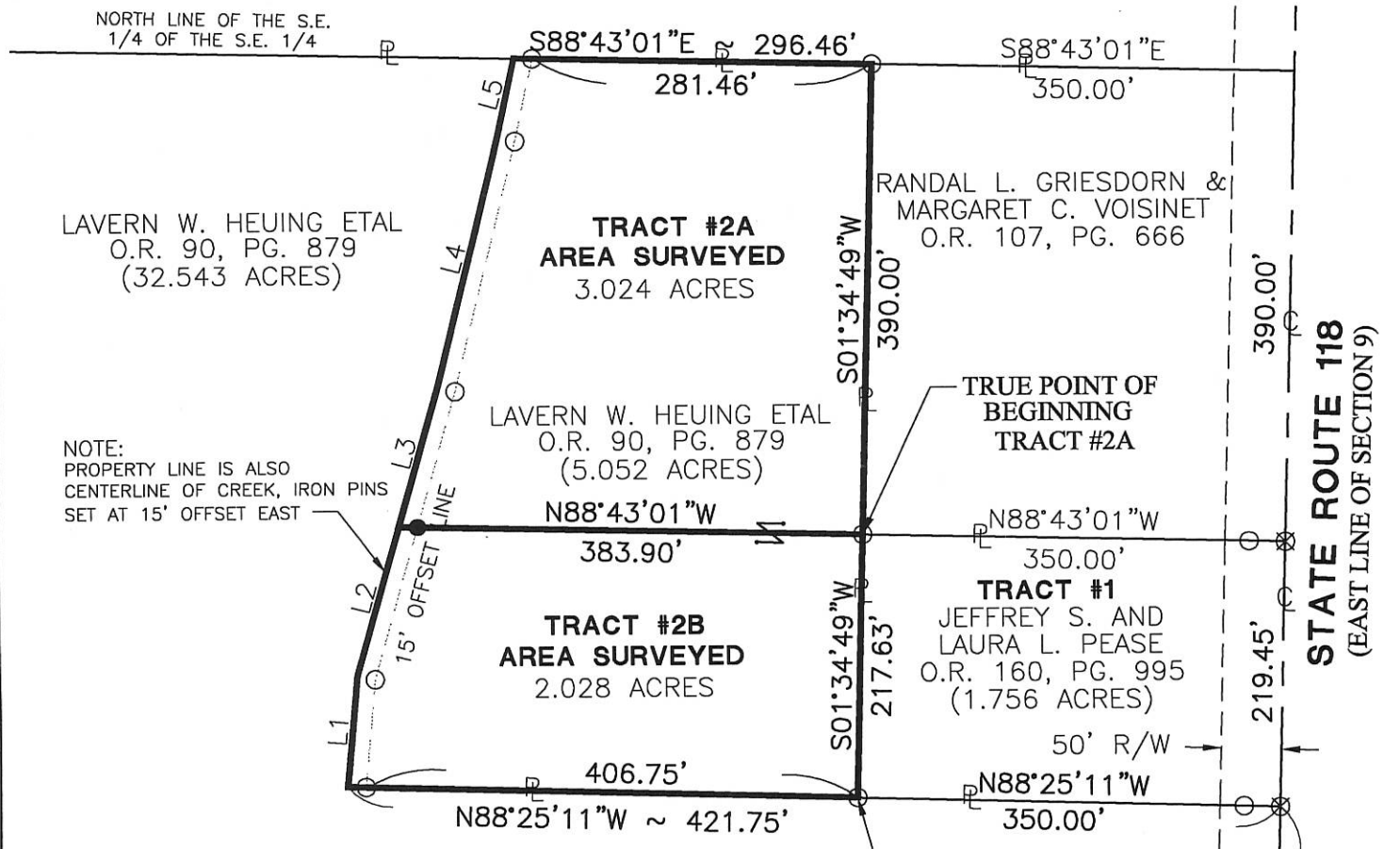

NOTES:
TRACT #2A IS TO BECOME PART OF RANDAL L. GRIESDORN AND MARGARET C. VOISINET AS RECORDED IN O.R. 107, PAGE 666
TRACT #2B IS TO BECOME PART OF JEFFREY S. AND LAURA L. PEASE AS RECORDED IN O.R. 160, PAGE 995

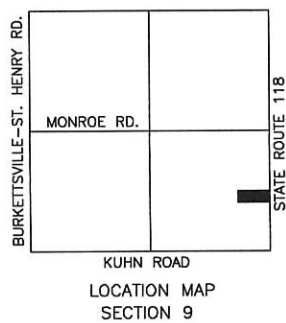

#	BEARING	DIST.
L1	N05°24'45"E	91.72'
L2	N15°55'11"E	128.12'
L3	N15°55'11"E	120.85'
L4	N13°52'06"E	212.79'
L5	N12°09'11"E	66.58'

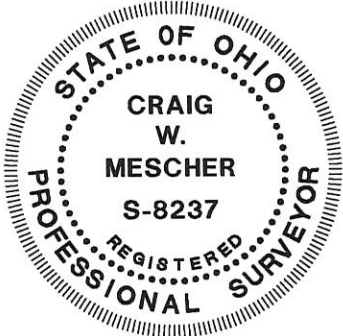

#1 = 0809400009
#2A = 0809400006
#2B = 0809400015

Fanning/Howey
Civil Engineering Division
Engineers Surveyors Consultants
1200 IRMSCHER BOULEVARD, CELINA, OHIO 45822
PH: (419) 586-2292 FAX: (419) 586-3393
www.fhai.com/civilengineering

Surveyed By: *Craig W. Mescher*
Craig W. Mescher Reg. Surveyor No. 8237
Date: 04-23-04

- LEGEND**
- Iron Pin Found
 - Iron Pin Set
 - ⊙ P.K. Nail Set
 - ⊗ P.K. Nail Found

References: Basis of Bearings from Mercer County G.P.S. System
Lavern W. Heuing survey by Eric C. Thomas in December of 2002.

Scale: 1" = 150'

Part of S.E. 1/4 Sec. 9 T6-S R2-E JEFFERSON Twp., Mercer Co., OH
Grantor: _____ Deeds: _____ Area Retained _____ Ac.
Grantee: _____ Area _____ Ac.

Approvals: _____	Co. San. Eng	Co. Engineer	Permanent Parcel No.
Agency: Bd. of Health			
Date: _____			

080940008

08-B

SURVEY OF A 2.571 AC. TRACT FOR VIRGINIA CORDIER LOCATED IN THE S.E. 1/4 OF SECTION 09, T-6-S, R-2-E, JEFFERSON TOWNSHIP, MERCER COUNTY, STATE OF OHIO

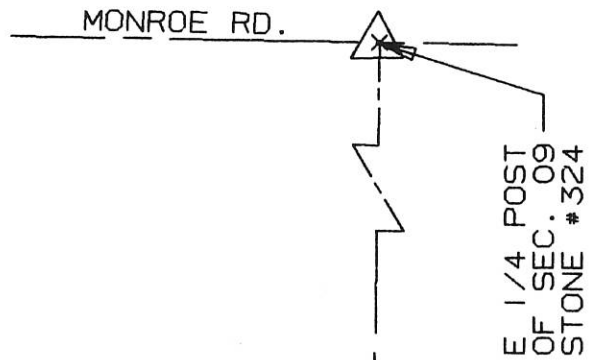
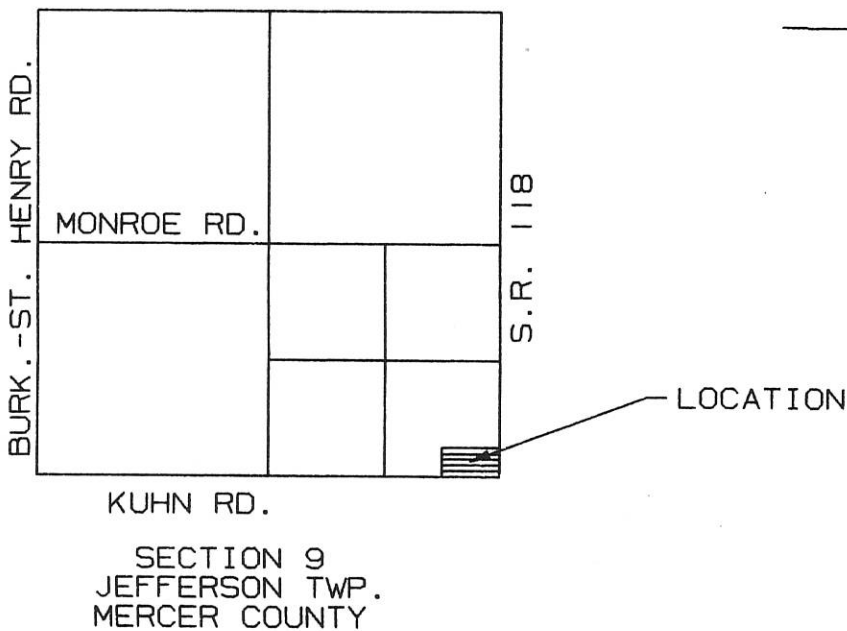

VIRGINIA CORDIER
O.R. 3 PG. 1008

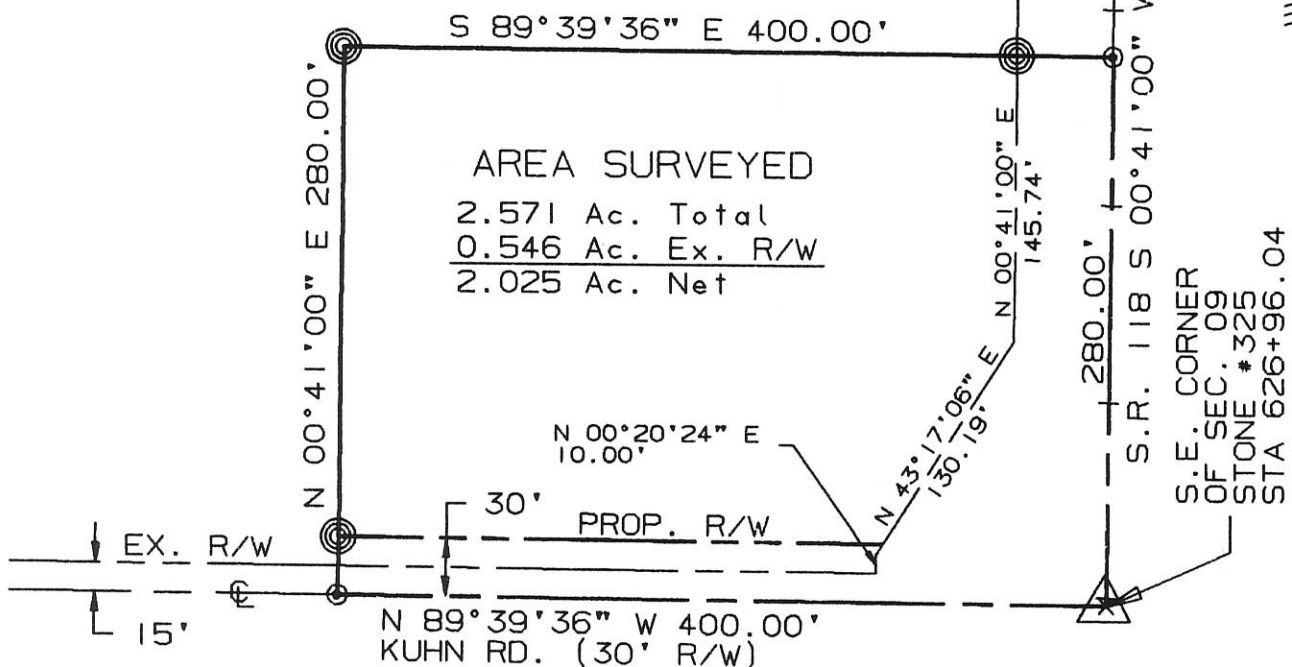

I hereby dedicate the permanent easement (thirty feet total) for roadway purposes as shown on this plat.

Virginia Cordier
Virginia Cordier

SURVEYED BY: *Eric C. Thomas*
ERIC C THOMAS REG. SURVEYOR #7236
DATE: 09-10-96

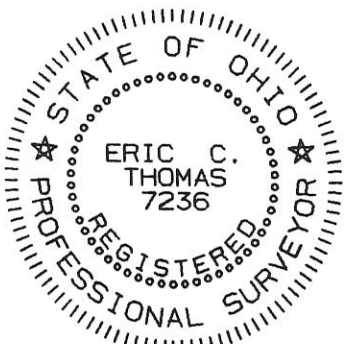

References: R/W PLANS OF S.R. 118 ON FILE IN THE MERCER CO. ENG.'S OFFICE		Scale 1"=100' 0 50 100 200	
Part of S.E. 1/4 Sec. 09 T-6-S R-2-E JEFFERSON Twp., MERCER Co., OHIO			
GRANTOR: V. CORDIER DEEDS: O.R. 3 Pg. 1008 AREA RETAINED _____ Ac.			
GRANTEE: _____ AREA: _____ Ac.			
APPROVALS:	BD. OF HEALTH	Co. San. Eng.	Co. Engineer
AGENCY:			
DATE:			PERMANENT PARCEL No.

SURVEY OF A 2.571 AC. TRACT FOR VIRGINIA CORDIER
 LOCATED IN THE S.E. 1/4 OF SECTION 09, T-6-S, R-2-E,
 JEFFERSON TOWNSHIP, MERCER COUNTY, STATE OF OHIO

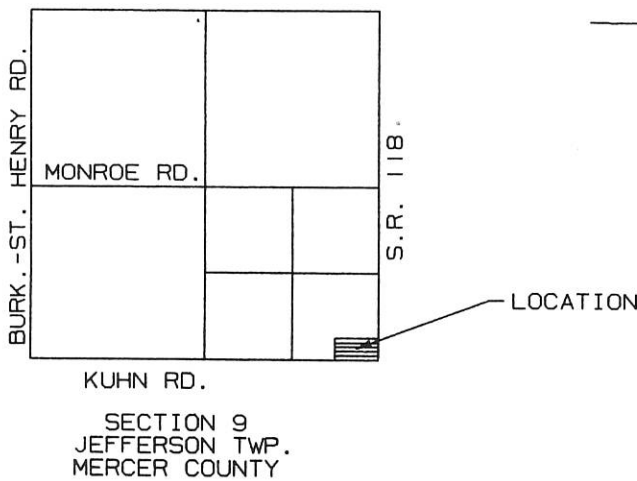

VIRGINIA CORDIER
 O.R. 3 PG. 1008

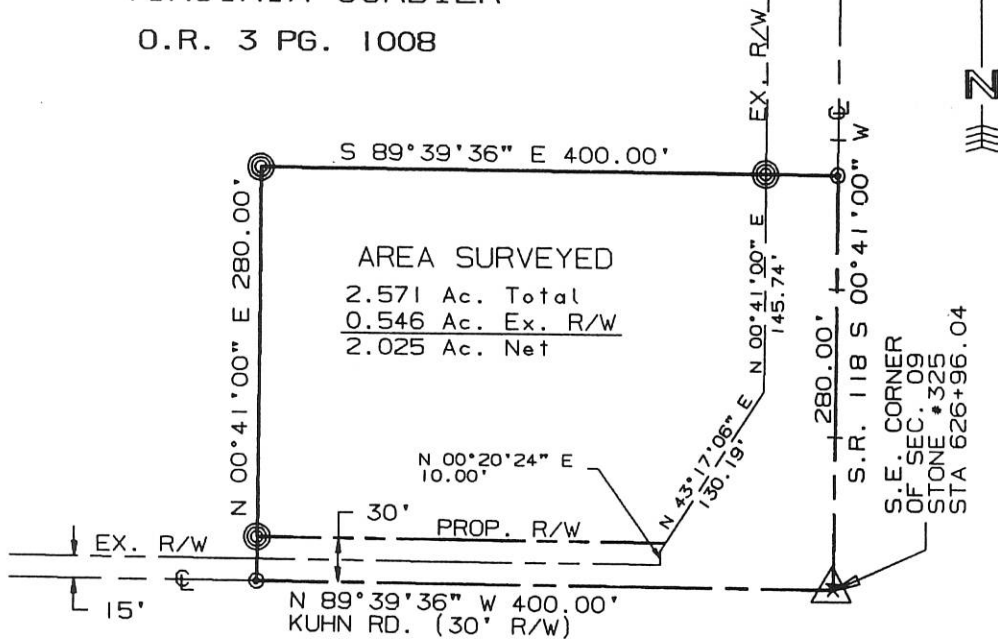

089400008

I hereby dedicate the permanent easement (thirty feet total) for roadway purposes as shown on this plat.

Virginia Cordier
 Virginia Cordier

SURVEYED BY: *Eric C. Thomas*
 ERIC C THOMAS REG. SURVEYOR #7236
 DATE: 09-10-96

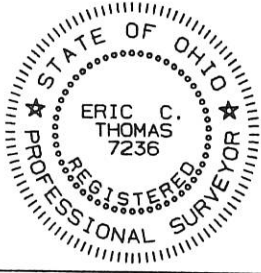

References: R/W PLANS OF S.R. 118 ON FILE IN THE MERCER CO. ENG.'S OFFICE		Scale 1"=100' 0 50 100 200	
Part of S.E. 1/4 Sec. 09 T6-S R2-E JEFFERSON Twp., MERCER Co., OHIO			
GRANTOR: V. CORDIER DEEDS: O.R. 3 Pg. 1008 AREA RETAINED ____ Ac.			
GRANTEE: _____ AREA: _____ Ac.			
APPROVALS:	BD. OF HEALTH	Co. San. Eng.	Co. Engineer
AGENCY:			PERMANENT PARCEL No.
DATE			

SURVEY FOR LAVERN W. HEUING ETAL

BEING A PARCEL OF LAND LOCATED IN THE SOUTHEAST QUARTER OF THE SOUTHEAST QUARTER OF SECTION 9, JEFFERSON TOWNSHIP, TOWN 6 SOUTH, RANGE 2 EAST, MERCER COUNTY, OHIO

NOTE:
PROPERTY LINE IS ALSO
CENTERLINE OF CREEK, IRON PINS
SET AT 15' OFFSET EAST

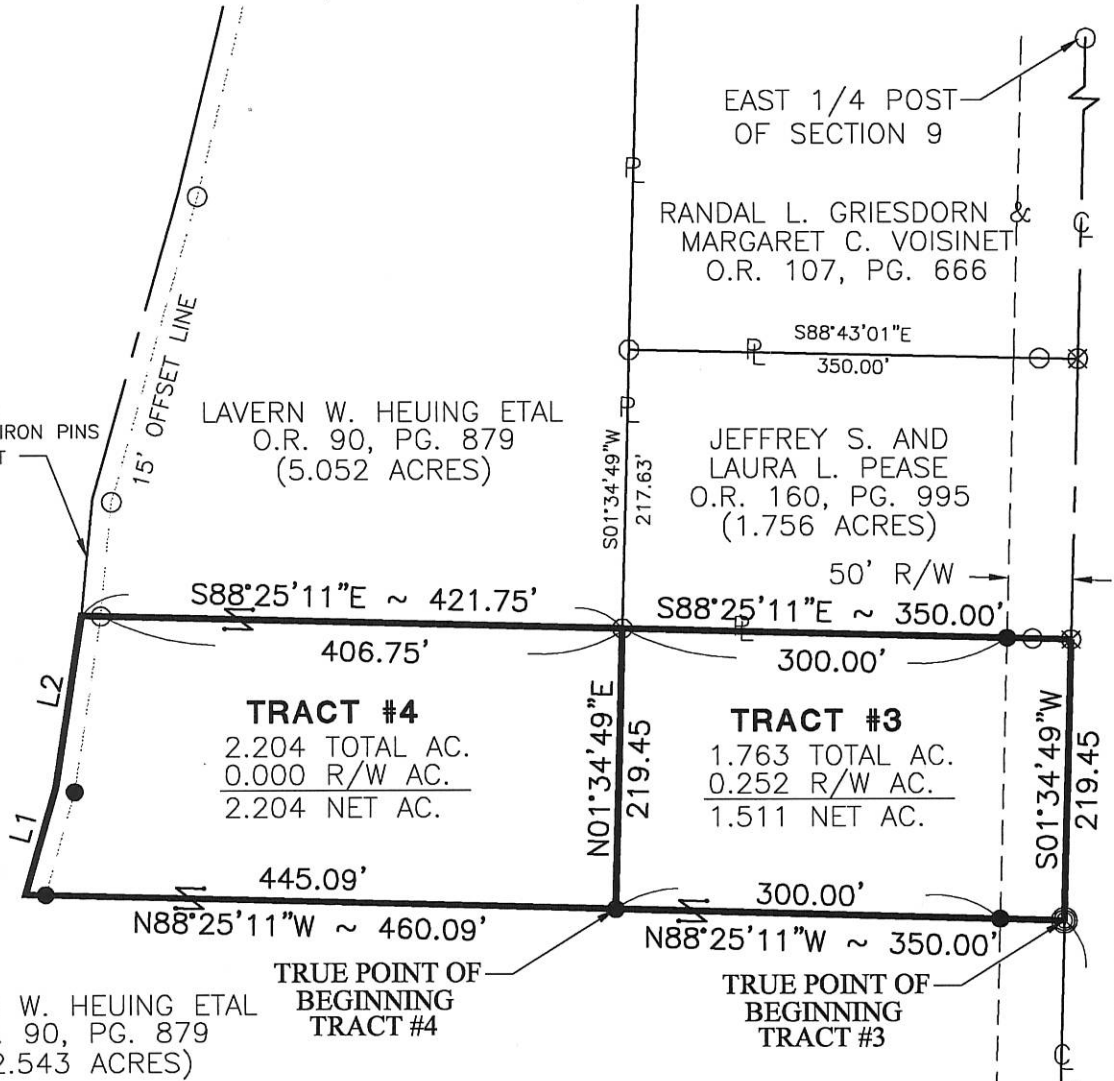

LAVERN W. HEUING ETAL
O.R. 90, PG. 879
(32.543 ACRES)

TRUE POINT OF
BEGINNING
TRACT #4

TRUE POINT OF
BEGINNING
TRACT #3

NOTES:
TRACT #4 WILL BE SOLD WITH AND IS PART OF
TRACT #3 HAVING 3.967 ACRES TOTAL

#	BEARING	DIST.
L1	N15°54'36"E	86.64'
L2	N08°41'23"E	136.56'

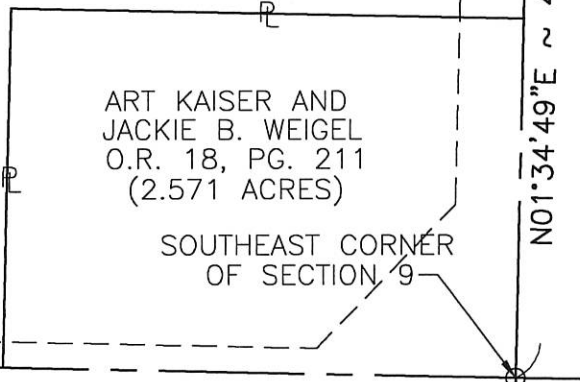

Fanning/Howey
Civil Engineering Division

Engineers Surveyors Consultants
1200 IRMSCHER BOULEVARD, CELINA, OHIO 45822
PH: (419) 586-2292 FAX: (419) 586-3393
www.fhai.com/civilengineering

Surveyed By: *Craig W. Mescher*
Craig W. Mescher Reg. Surveyor No. 8237
Date: 04-19-04

LEGEND

- Iron Pin Found
- Iron Pin Set
- ⊙ P.K. Nail Set
- ⊗ P.K. Nail Found

References: Basis of Bearings from Mercer County G.P.S. System
Lavern W. Heuing survey by Eric C. Thomas in December of 2002.

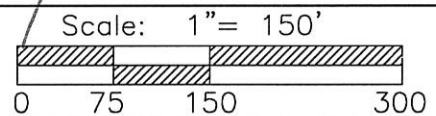

Part of S.E. 1/4 Sec. 9 T6-S R2-E JEFFERSON Twp., Mercer Co., OH
Grantor: _____ Deeds: _____ Area Retained _____ Ac.
Grantee: _____ Area _____ Ac.

Approvals: _____
Agency: Bd. of Health Co. San. Eng Co. Engineer Permanent Parcel No.
Date: _____

08-B

SURVEY FOR LAVERN W. HEUING ETAL

BEING A PARCEL OF LAND LOCATED IN THE SOUTHEAST QUARTER OF THE SOUTHEAST QUARTER OF SECTION 9, JEFFERSON TOWNSHIP, TOWN 6 SOUTH, RANGE 2 EAST, MERCER COUNTY, OHIO

#	BEARING	DIST.
L1	N05°24'45"E	91.72'
L2	N15°55'11"E	248.97'
L3	N13°52'06"E	212.79'
L4	N12°09'11"E	66.58'

EAST 1/4 POST OF SEC. 9

MICHAEL D & JULIE R DUES
O.R. 99, PG. 242

NORTH LINE OF THE S.E.
1/4 OF THE S.E. 1/4

S88°43'01"E
296.46'

350.00'

NOTE:
PROPERTY LINE ALSO CENTERLINE
OF CREEK, IRON PINS ARE
SET 15' OFFSETS

TRACT #2
5.052 TOTAL AC.
0.000 R/W AC.
5.052 NET AC.

RANDAL L. GRIESDORN &
MARGARET C. VOISINET
O.R. 107, PG. 666

TRUE POINT OF
BEGINNING
TRACT #2

TRACT #1
1.756 TOTAL AC.
0.151 R/W AC.
1.605 NET AC.

TRUE POINT OF
BEGINNING
TRACT #1

LAVERN W. HEUING ETAL
O.R. 90, PG. 879

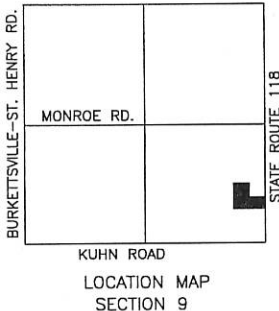
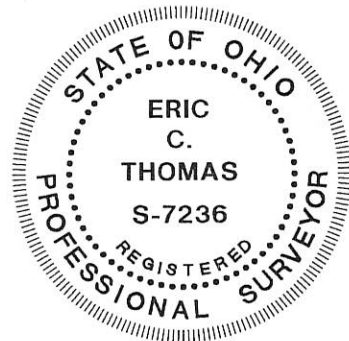

S.E. COR.
OF SEC. 9

0809400009
0809400015
0809400006

Surveyed By: Eric C. Thomas
Eric C. Thomas Reg. Surveyor No. 7236
Date: 12-09-02

- Iron Pin Found
- Iron Pin Set
- ⊙ P.K. Nail Set
- ⊗ P.K. Nail Found

References: Basic of Bearings from Mercer
County G.P.S. System

Scale: 1" = 150'

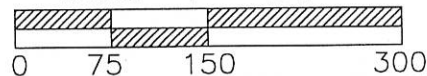

Part of S.E. 1/4 Sec. 9 T6-S R2-E JEFFERSON Twp., Mercer Co., OH
Grantor: _____ Deeds: _____ Area Retained _____ Ac.
Grantee: _____ Area _____ Ac.

ERIC C. THOMAS
208 S. CEDAR
COLDWATER OH 45828

DRAWN BY:
ROBB BECKSTEDT

Approvals: _____
Agency: Bd. of Health
Date: _____

Co. San. Eng

Co. Engineer

Permanent Parcel No.

SURVEY FOR LAVERN W. HEUING ETAL

BEING A PARCEL OF LAND LOCATED IN THE SOUTHEAST QUARTER OF THE SOUTHEAST QUARTER OF SECTION 9, JEFFERSON TOWNSHIP, TOWN 6 SOUTH, RANGE 2 EAST, MERCER COUNTY, OHIO

NOTE:
PROPERTY LINE IS ALSO
CENTERLINE OF CREEK, IRON PINS
SET AT 15' OFFSET EAST

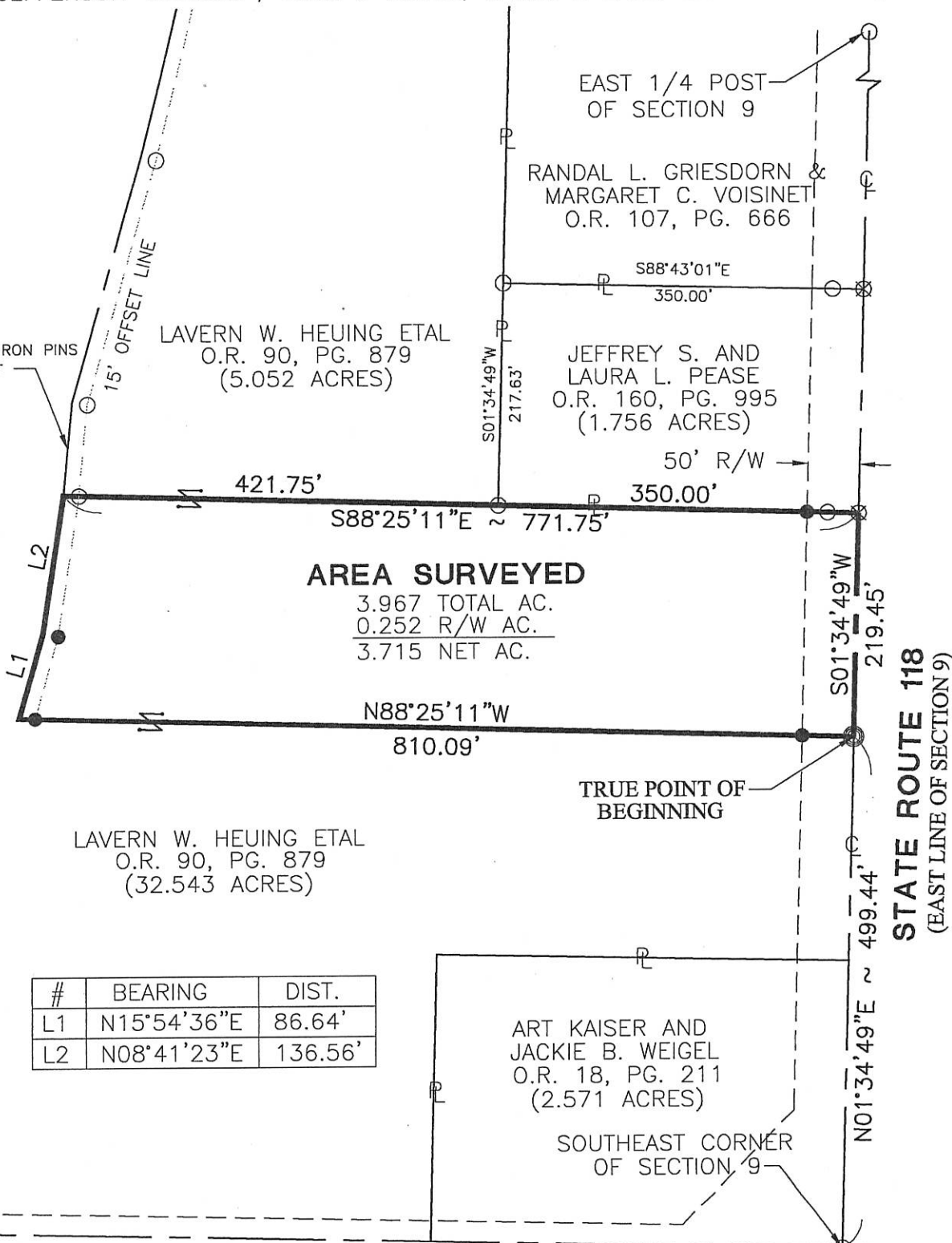

KUHN ROAD

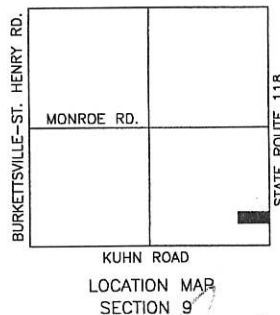
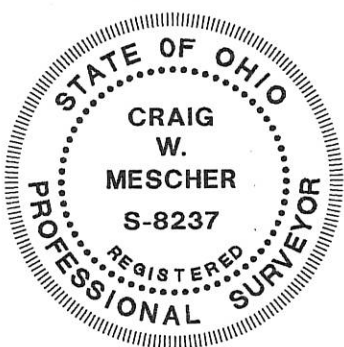

Fanning/Howey
Civil Engineering Division
Engineers Surveyors Consultants
1200 IRMSCHER BOULEVARD, CELINA, OHIO 45822
PH: (419) 586-2292 FAX: (419) 586-3393
www.fhai.com/civilengineering

Surveyed By: *Craig W. Mescher*
Craig W. Mescher Reg. Surveyor No. 8237
Date: 04-19-04

LEGEND

- Iron Pin Found
- Iron Pin Set
- ⊙ P.K. Nail Set
- ⊗ P.K. Nail Found

References: Basis of Bearings from Mercer County G.P.S. System
Lavern W. Heuing survey by Eric C. Thomas in December of 2002.

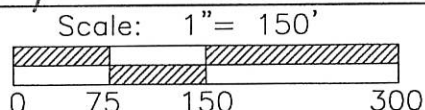

Part of S.E.1/4 Sec. 9 T6-S R2-E JEFFESON Twp., Mercer Co., OH
Grantor: _____ Deeds: _____ Area Retained _____ Ac.
Grantee: _____ Area _____ Ac.

Approvals: _____
Agency: Bd. of Health _____ Co. San. Eng _____ Co. Engineer _____ Permanent Parcel No. _____
Date: _____

**SURVEY OF A 1.077 ACRE PARCEL & A
1.233 ACRE PARCEL FOR LAVERN HEUING**

LOCATED IN THE S.E. 1/4 OF SEC. 9, T-6-S,
R-2-E, JEFFERSON TWP., MERCER CO., OHIO

**A=0809400011
B=0809400013**

OWNER: LAVERN W. HEUING, CLARENCE
HEUING & MARILYN TOBE
O.R. 90, P. 879
(34.299 AC. DEED)

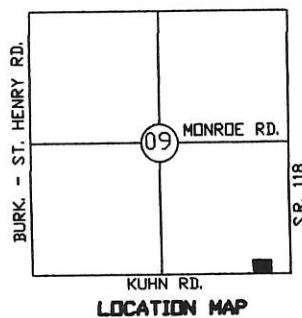
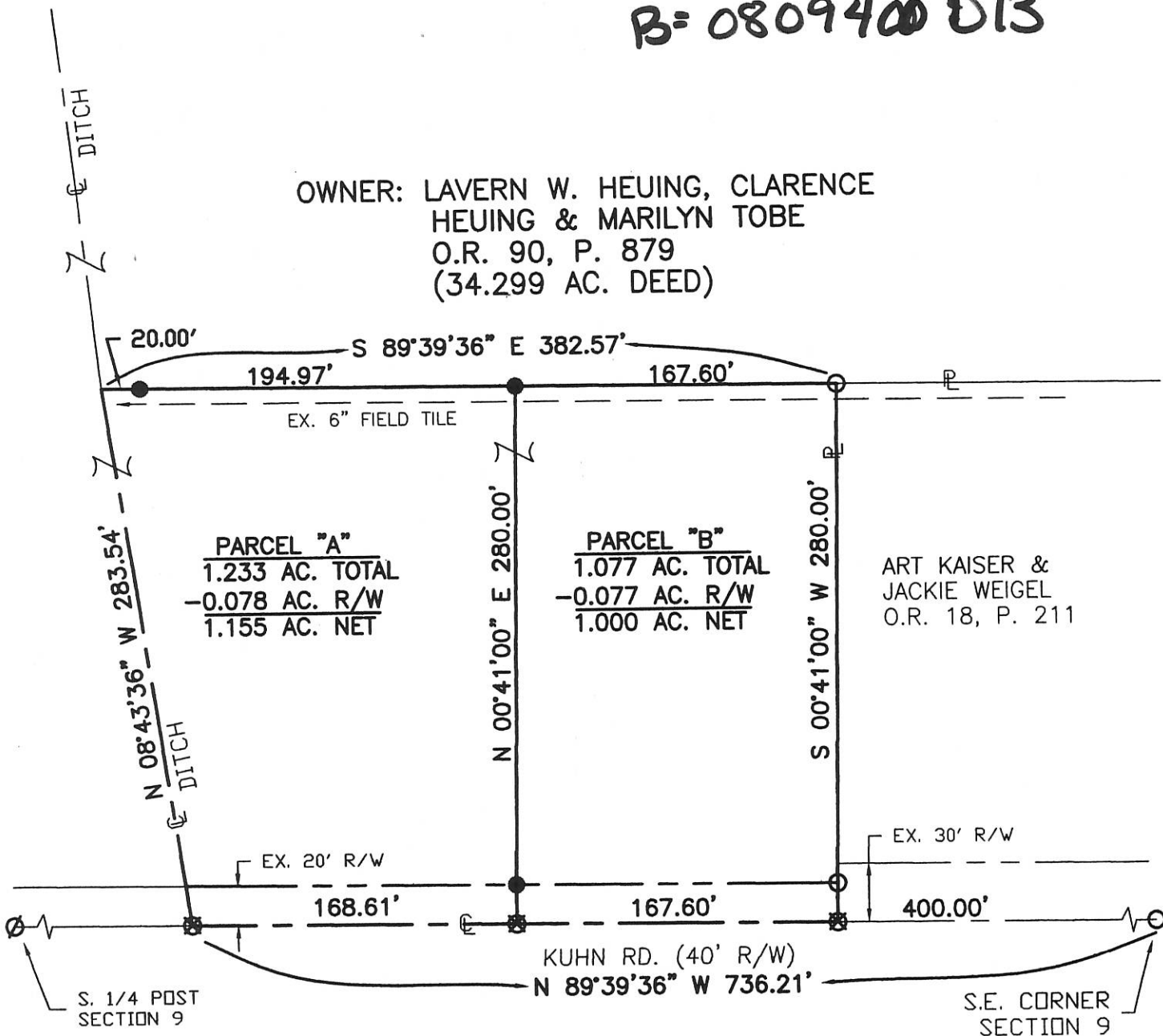

LEGEND

- Iron Pin Found
- Iron Pin Set
- ∅ P.K. Nail Found
- ⊗ P.K. Nail Set



Surveyed By: *Eric C. Thomas*
Eric C. Thomas Reg. Surveyor No. 7236
Date: 11-21-05

References:
PREVIOUS SURVEY OF THE AREA BY THIS SURVEYOR

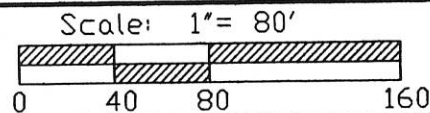

Part of S.E. 1/4 Sec. 9 T. 6-S R. 2-E JEFFERSON Twp., Mercer Co., OH
Grantor: _____ Deeds: _____ Area Retained _____ Ac.
Grantee: _____ Area _____ Ac.

Approvals: _____	_____	_____	_____
Agency: Bd. of Health	Co. San. Eng	Co. Engineer	Permanent Parcel No.
Date: _____			

08-B ✓

0809400014

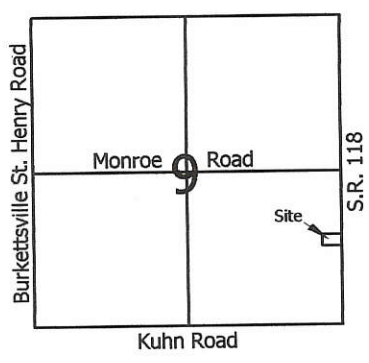

Scale: 1" = 100'

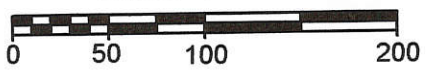

Legend:

- ▲ Cornerstone @ the E1/4 post of Section 9
- △ Cornerstone @ the SE corner of Section 9
- 5/8" X 30" Iron pin w/cap set
- Mag nail set

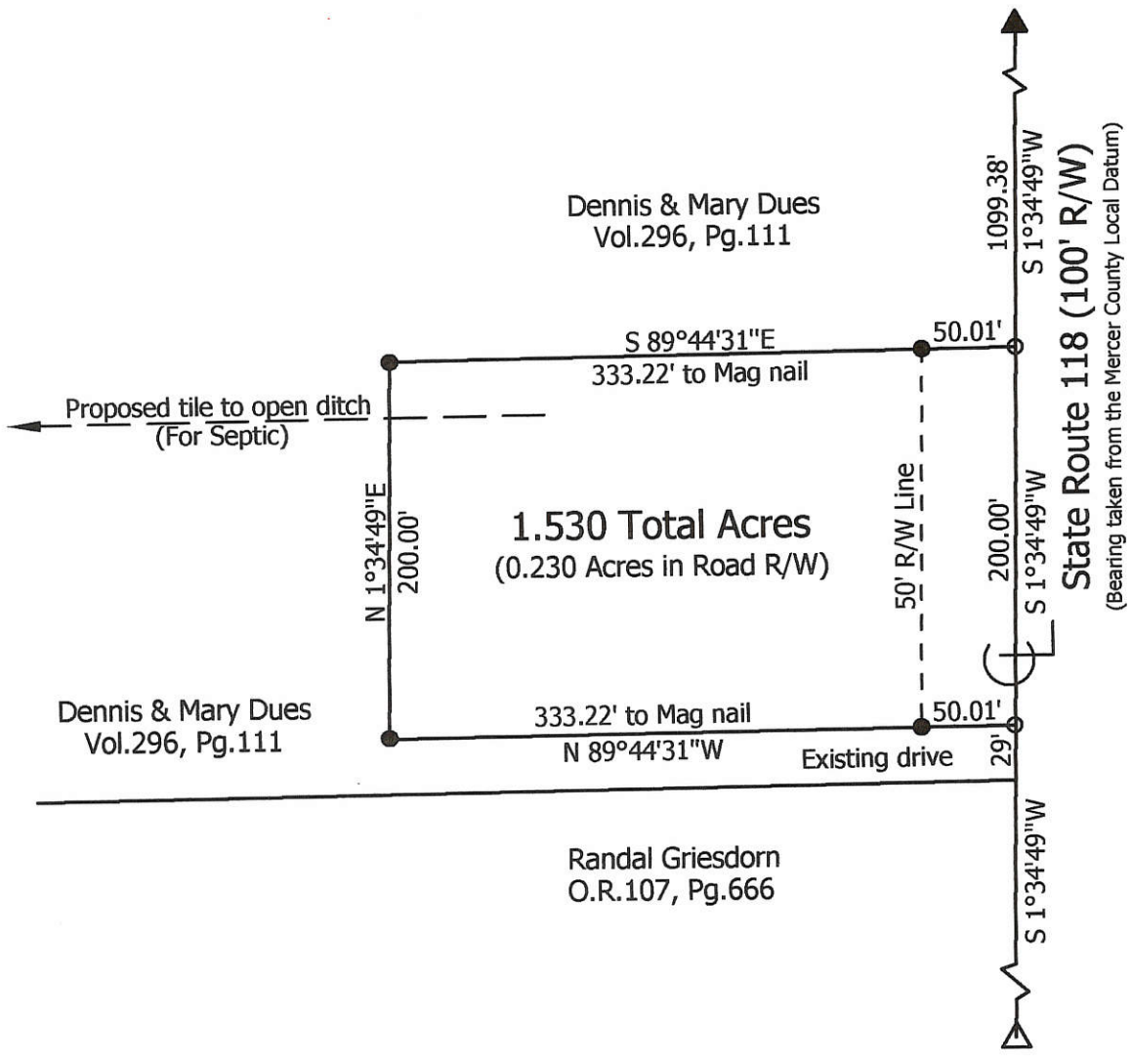

**Marbaugh
Land Surveying**

1210 Yorkshire Court
Celina, Ohio 45822
(419) 586-4293



Dennis & Mary Dues Survey

State of: Ohio County: Mercer
 Township: Jefferson Sec: 9 Town: 6S Range: 2E
 City/Village: _____ Subdivision: _____ Lot: _____
 Deed Ref: Vol.296, Pg.111 Date Surveyed: 2-3-06

Approvals: _____
 Agency: Board of Health Township Zoning Inspector County Engineer
 Date: _____

Kent Marbaugh
 Kent B. Marbaugh P.S.7421

08-B ✓