

- Legend:**
- ▲ Cornerstone @ the W1/4 post of Section 17
 - ▲ Cornerstone @ the NW corner of Section 17
 - Mag nail set
 - 5/8" X 30" Iron pin w/cap set
 - 5/8" X 30" Iron pin w/cap set on line and 20.00' from corner
 - Corner post @ the center of Section 17

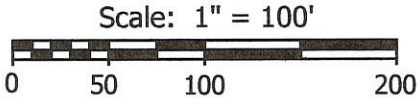

Note: Reference is made to the Pierstorff Survey by Gordon Geeslin

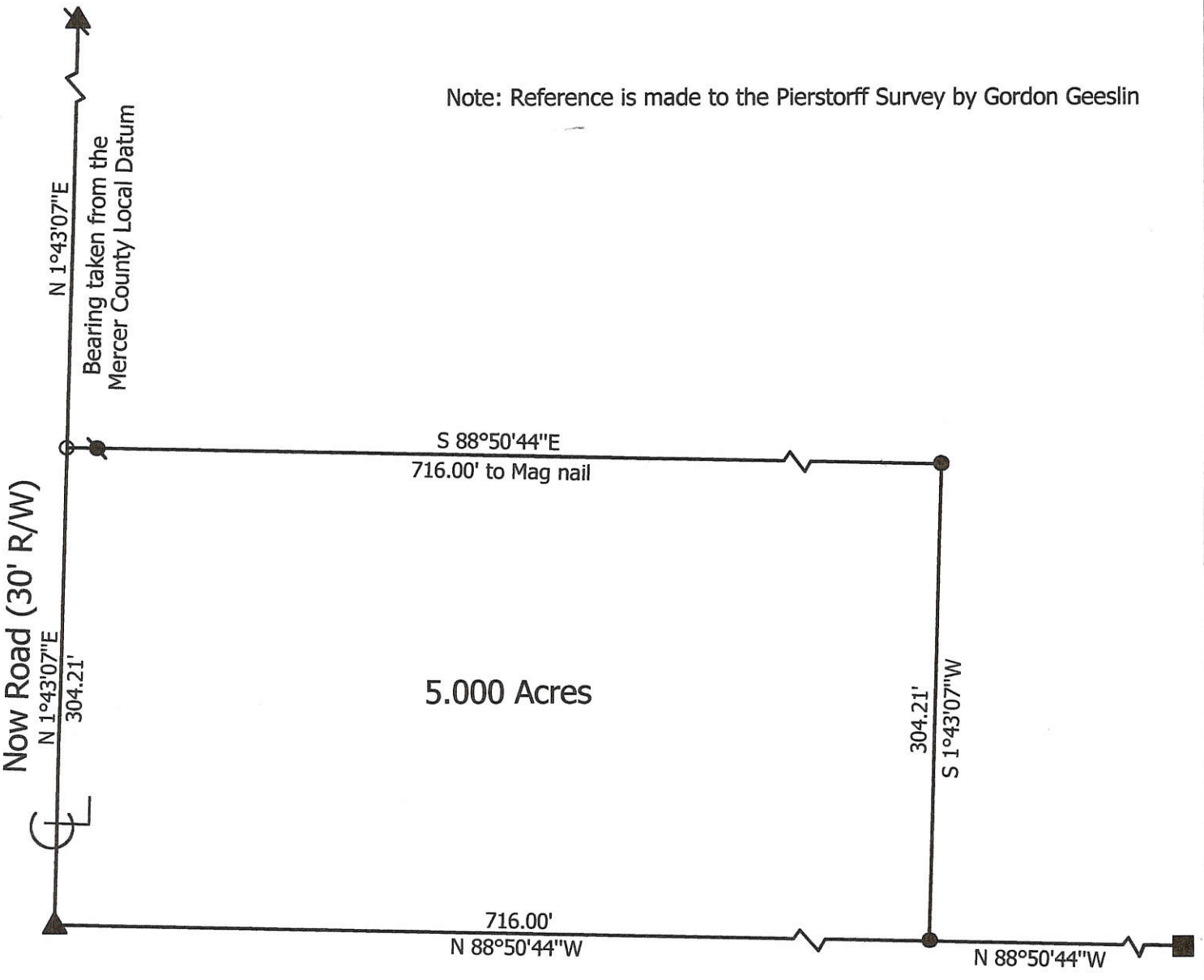

**Marbaugh
Land Surveying**

1210 Yorkshire Court
Celina, Ohio 45822
(419) 586-4293

Kent Marbaugh
Kent B. Marbaugh P.S. 7421



Schaadt Survey

State of: Ohio County: Mercer
 Township: Hopewell Sec: 17 Town: 5S Range: 2E
 City/Village: _____ Subdivision: _____ Lot: _____
 Deed Ref: Vol.303 Pg.737 Date Surveyed: 4-22-02

Approvals: _____	_____	_____
Agency: Board of Health	Township Zoning Inspector	County Engineer
Date: _____		

05-17-100-005/05-D

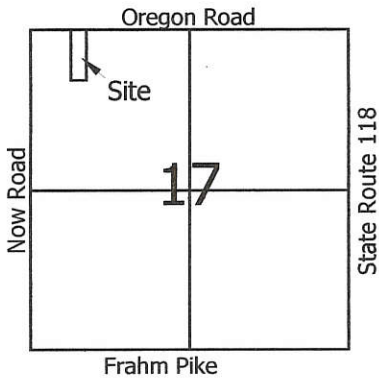

Legend:

- ▲ Cornerstone @ the N1/4 post of Section 17
- ▲ Cornerstone @ the NW corner of Section 17
- Mag nail set
- 5/8" X 30" Iron pin w/cap set
- ⊙ 5/8" X 30" Iron pin w/cap set on line and 20.00' from corner

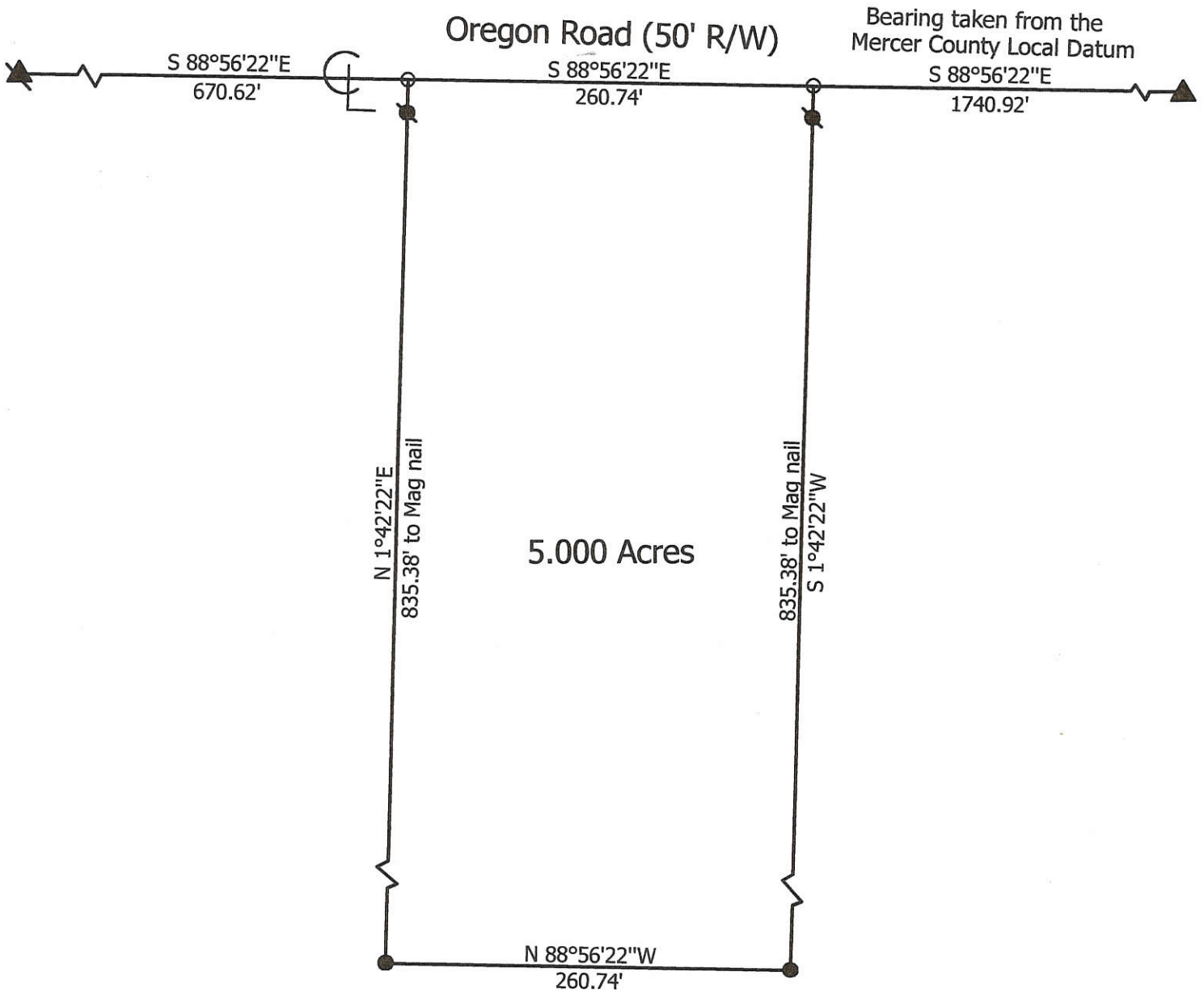
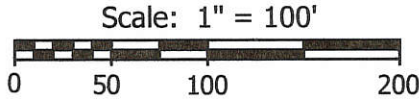

**Marbaugh
Land Surveying**

1210 Yorkshire Court
Celina, Ohio 45822
(419) 586-4293

Kent Marbaugh
Kent B. Marbaugh P.S.7421



Schaadt Survey

State of: Ohio County: Mercer
 Township: Hopewell Sec: 17 Town: 5S Range: 2E
 City/Village: _____ Subdivision: _____ Lot: _____
 Deed Ref: Vol.303 Pg.737 Date Surveyed: 4-20-02

Approvals: _____	_____	_____
Agency: Board of Health	Township Zoning Inspector	County Engineer
Date: _____		

PIERSTORFF SURVEY

PART OF THE S.W. 1/4 OF SECTION 17, TOWNSHIP 5 SOUTH, RANGE 2 EAST, (HOPEWELL TOWNSHIP), MERCER COUNTY, OHIO.

APRIL 14, 2011

SCALE 1" = 200'

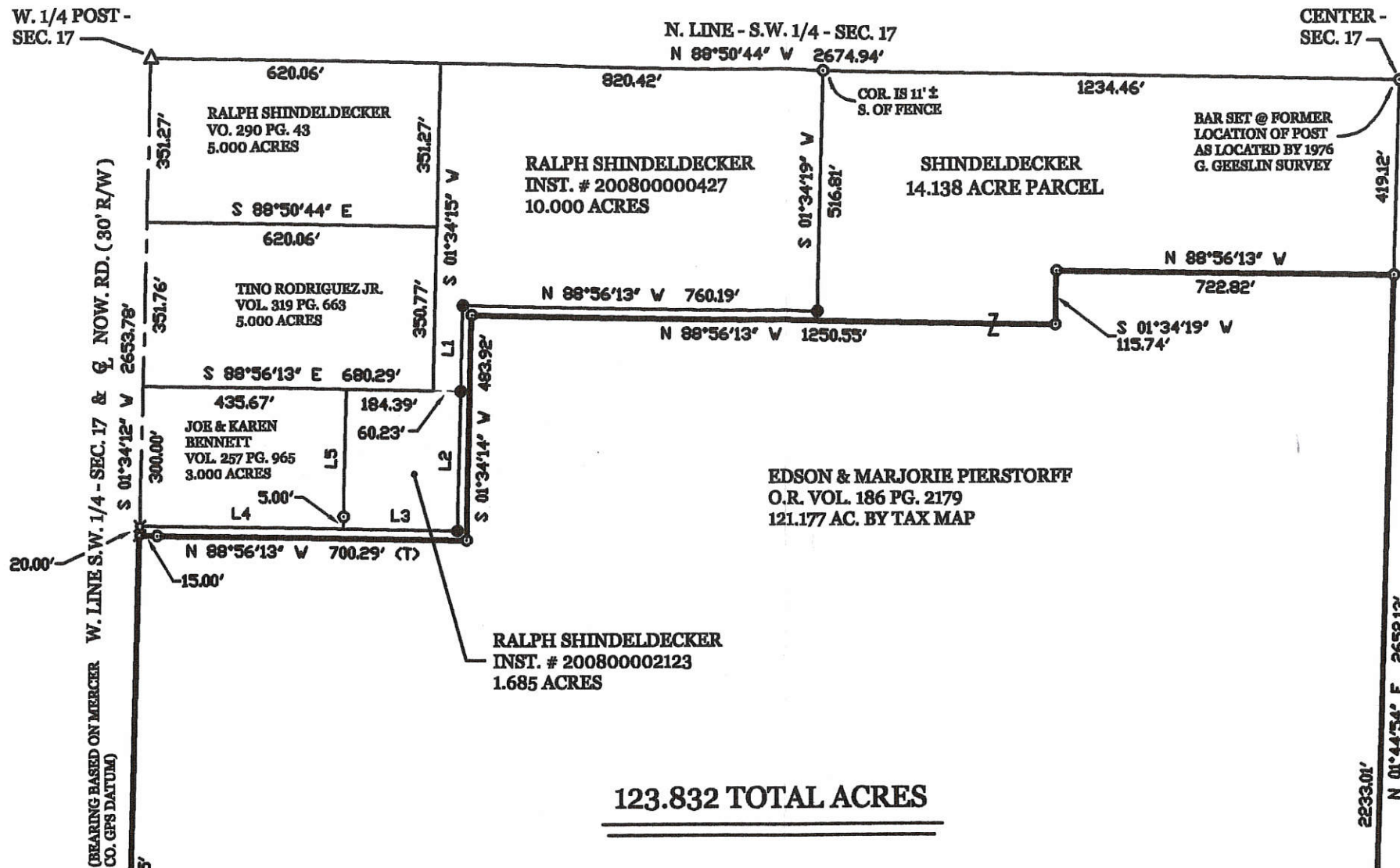

123.832 TOTAL ACRES

LEGEND

- △ = CORNERSTONE.
- ✕ = RAILROAD SPIKE FOUND.
- = MAG NAIL FOUND.
- = 5/8 INCH IRON BAR FOUND.
- ✕ = HARROW TOOTH SPIKE FOUND.
- = 5/8 INCH IRON BAR SET.
- = MAG NAIL SET.

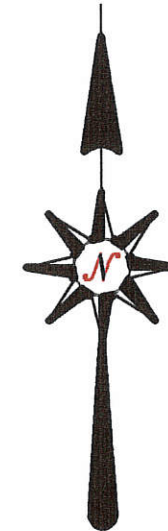

LOCATION SKETCH

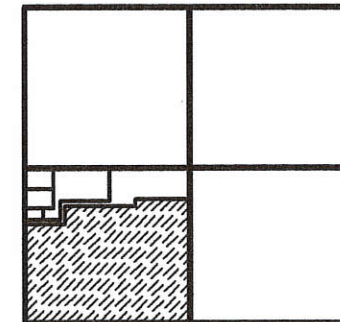

SECTION 17

05-D(17)

0517300001
-002
-003

GEESLIN SURVEYING

525 S. SECOND ST.
COLDWATER, OHIO 45828
PHONE (419) 678-7232

LINE TABLE

LINE	BEARING	DISTANCE
L1	S 01°34'14" W	183.92'
L2	S 01°34'14" W	300.00'
L3	N 88°56'13" W	244.62'
L4	N 88°56'13" W	435.67'
L5	S 01°34'12" W	300.00'

SURVEY REFERENCES :

- 1) PIERSTORFF SURVEY BY G. GEESLIN, P.S. 5372, DEC. 1976.
- 2) WILSON SURVEY BY G. GEESLIN, P.S. 5372, MAY 1978.
- 3) SCHAADT SURVEY BY K. MARBAUGH, APRIL 22, 2002.
- 4) PIERSTORFF SURVEY BY K. MARBAUGH, P.S. 7421, DEC. 27, 2007.
- 5) PIERSTORFF SURVEY BY K. MARBAUGH, P.S. 7421, FEB. 18, 2008.
- 5) PIERSTORFF SURVEY BY J. GEESLIN, P.S. 7764, 2-26-10.

SURVEYED BY

James W. Geeslin
JAMES W. GEESLIN, P.S. 7764

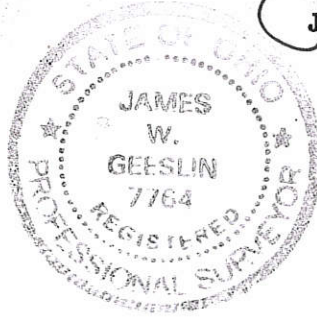

S.W. COR. - SEC. 17

S 88°52'58" E 2666.71'
S. LINE S.E. 1/4 - SEC. 17 & Q. FRAHM PIKE

POINT DETERMINED BY WILSON SURVEY BY G. GEESLIN, 5/78

S. 1/4 POST - SEC. 17

S.E. COR. - SEC. 17

S 88°52'58" E 2679.21'
S. LINE S.E. 1/4 - SEC. 17 & Q. FRAHM PIKE

0517300001
-002
-003

SURVEY REFERENCES :

- 1) PIERSTORFF SURVEY BY G. GEESLIN, P.S. 5372, DEC. 1976.
- 2) WILSON SURVEY BY G. GEESLIN, P.S. 5372, MAY 1978.
- 3) SCHAADT SURVEY BY K. MARAUGH, APRIL 22, 2002.
- 4) PIERSTORFF SURVEY BY K. MARAUGH, P.S. 7421, DEC. 27, 2007.
- 5) PIERSTORFF SURVEY BY K. MARAUGH, P.S. 7421, FEB. 18, 2008.

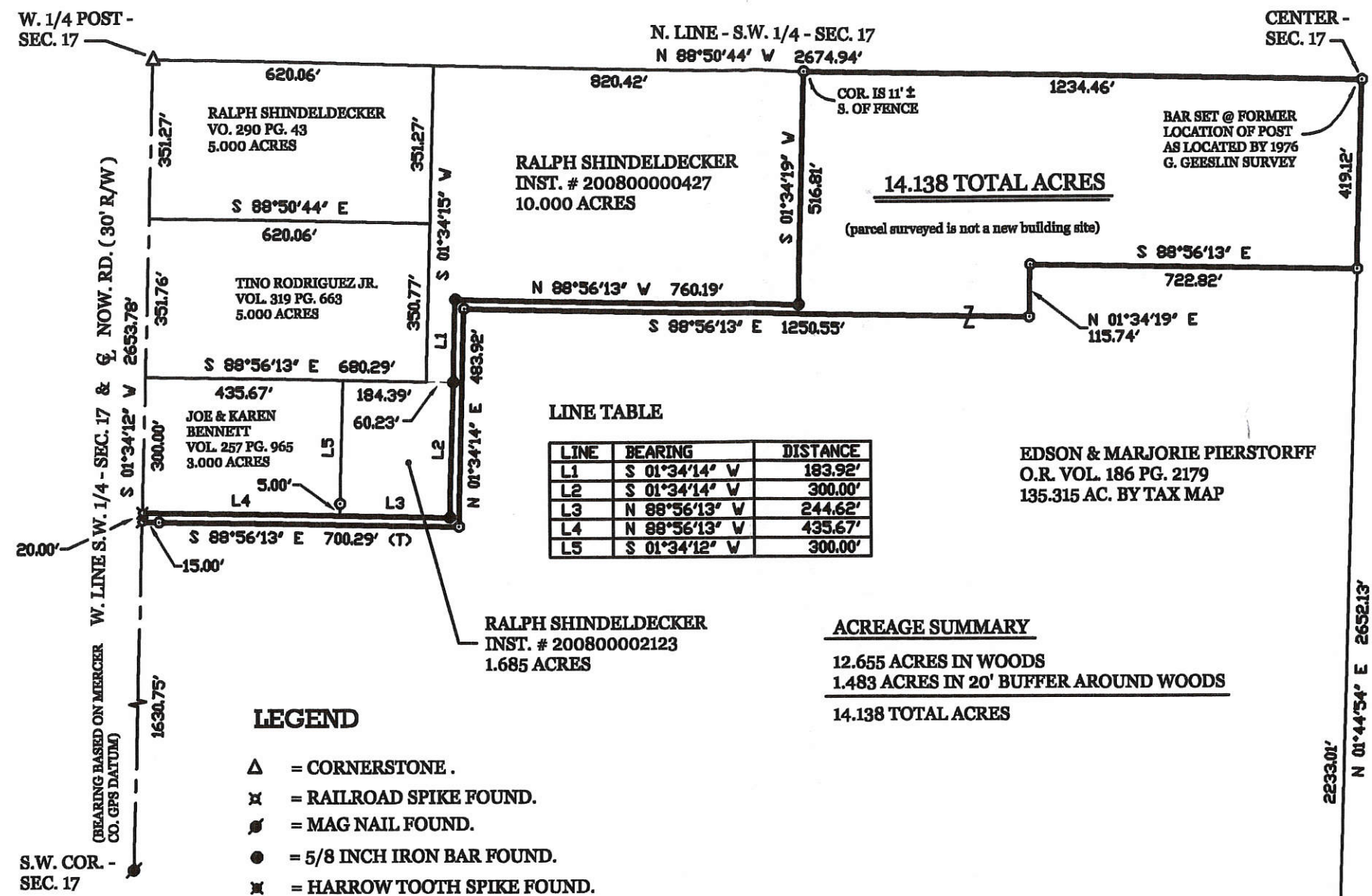

LINE TABLE

LINE	BEARING	DISTANCE
L1	S 01°34'14" V	183.92'
L2	S 01°34'14" V	300.00'
L3	N 88°56'13" V	244.62'
L4	N 88°56'13" V	435.67'
L5	S 01°34'12" V	300.00'

ACREAGE SUMMARY

12.655 ACRES IN WOODS
1.483 ACRES IN 20' BUFFER AROUND WOODS
14.138 TOTAL ACRES

LEGEND

- △ = CORNERSTONE.
- ✕ = RAILROAD SPIKE FOUND.
- = MAG NAIL FOUND.
- = 5/8 INCH IRON BAR FOUND.
- ✕ = HARROW TOOTH SPIKE FOUND.
- = 5/8 INCH IRON BAR SET.
- ⊙ = MAG NAIL SET.

SHINDELDECKER SURVEY

PART OF THE S.W. 1/4 OF SECTION 17, TOWNSHIP 5 SOUTH, RANGE 2 EAST, (HOPEWELL TOWNSHIP), MERCER COUNTY, OHIO.

FEBRUARY 26, 2010

SCALE 1" = 200'



LOCATION SKETCH

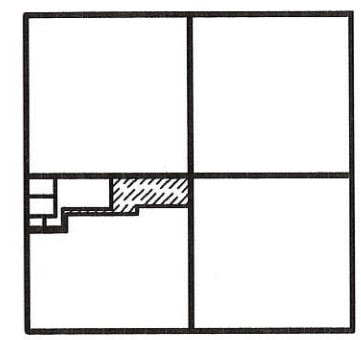

SECTION 17

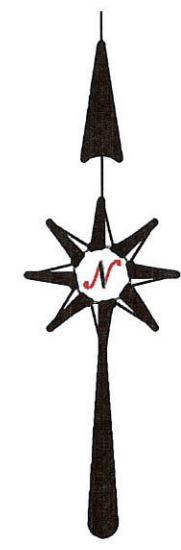

POINT DETERMINED BY WILSON SURVEY BY G. GEESLIN, 5/78

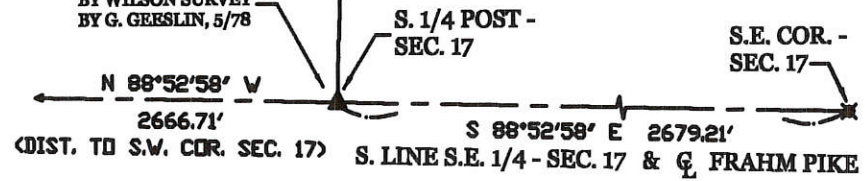

05-0(17)

GEESLIN LAND SURVEYING
525 S. SECOND ST.
COLDWATER, OHIO 45828
PHONE (419) 678-7232



SURVEYED BY

James W. Geeslin
JAMES W. GEESLIN, P.S. 7764

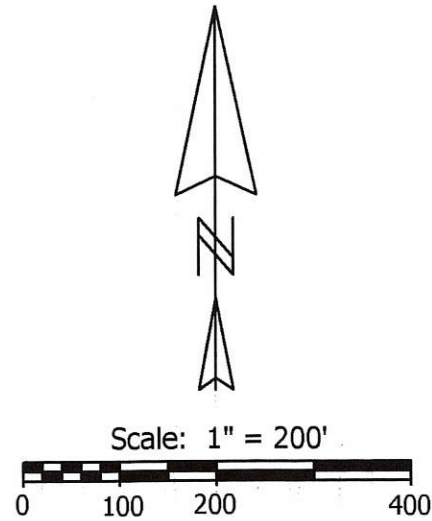
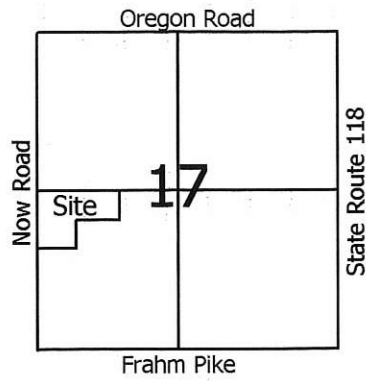

- Legend:**
- ▲ Cornerstone @ the W1/4 post of Section 17
 - ▲ Mag nail @ the SW corner of Section 17
 - Railroad spike found
 - ⊗ Iron pin found (Geeslin)
 - 5/8" X 30" Iron pin w/cap set
 - ⊗ Iron pipe found
 - Cornerpost @ the center of Section 17

0517300001
0517300002
0517300003

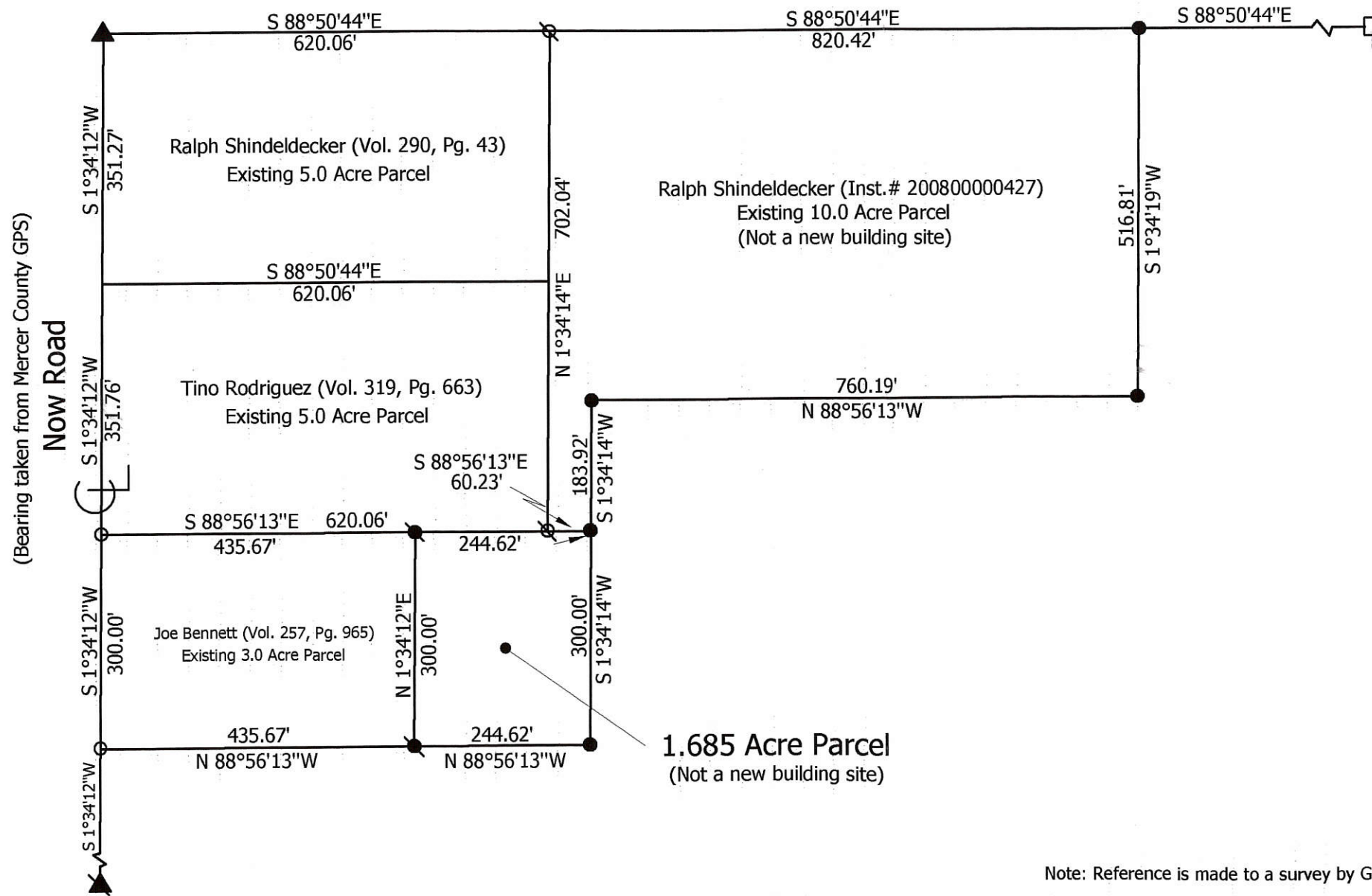

Note: Reference is made to a survey by Gordon Geeslin in december 1976

Pierstorff Survey

State of: Ohio County: Mercer

Township: Hopewell Sec: 17 Town: 5S Range: 2E

City/Village: _____ Subdivision: _____ Lot: _____

Deed References: O.R. 186, Pg. 2179 Date Surveyed: 2-18-08

Approvals: _____
Agency: Board of Health County Engineer _____
Date: _____

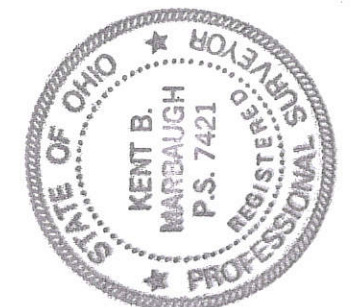

**Marbaugh
Land Surveying**

1901 Carolina Court
Celina, Ohio 45822
(419) 586-4293

Kent B. Marbaugh
Kent B. Marbaugh P.S. 7421

05-D

0517300001

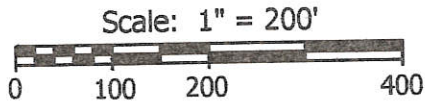
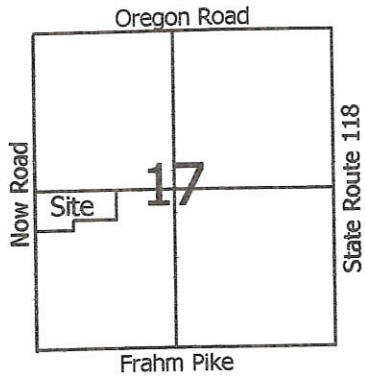

Legend:

- ▲ Cornerstone @ the W1/4 post of Section 17
- ⚡ Mag nail @ the SW corner of Section 17
- Railroad spike found
- ⊗ Iron pin found (Geeslin)
- 5/8" X 30" Iron pin w/cap set
- Cornerpost @ the center of Section 17

(Bearing taken from Mercer County GPS)

Now Road

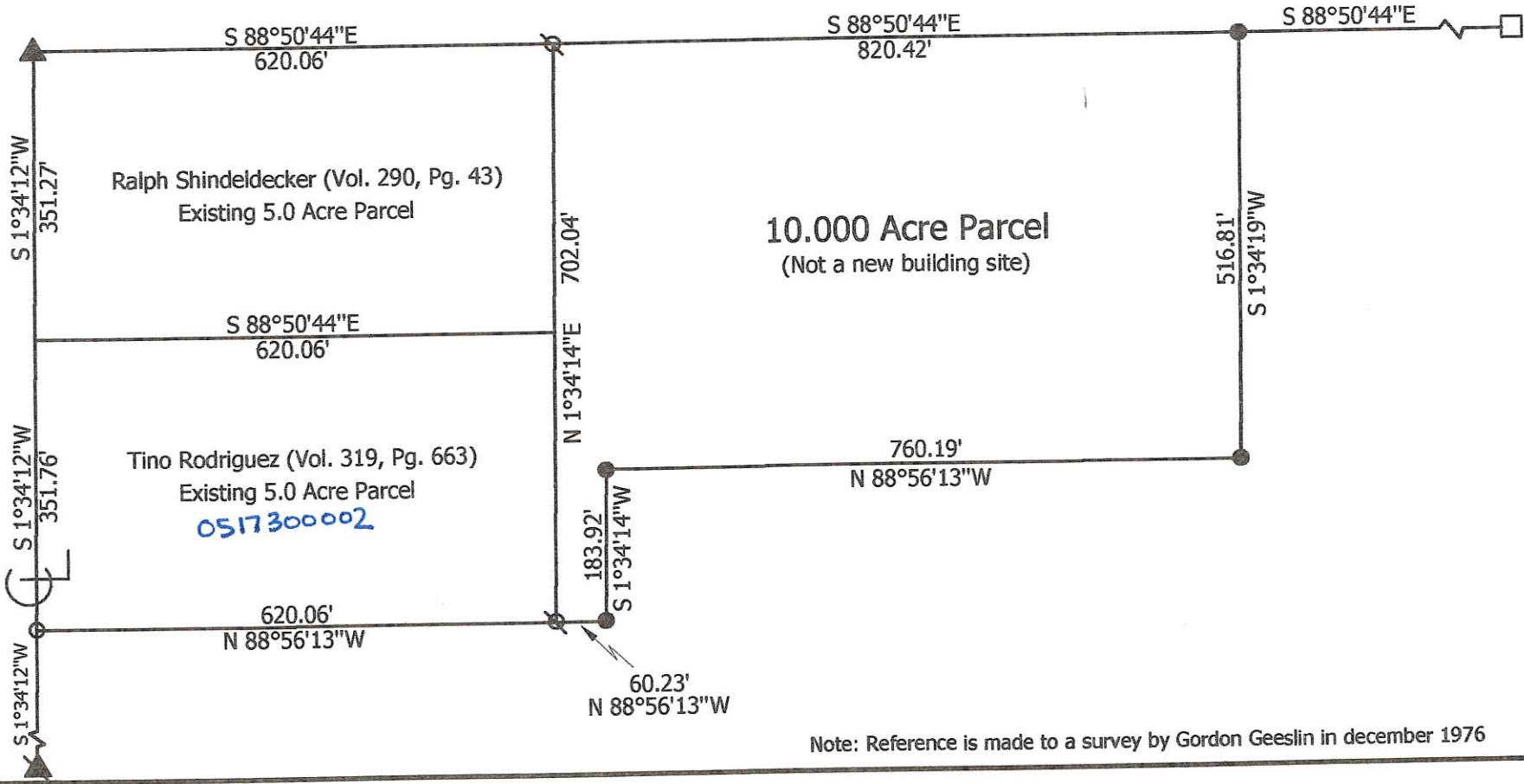

10.000 Acre Parcel
(Not a new building site)

Ralph Shindeldecker (Vol. 290, Pg. 43)
Existing 5.0 Acre Parcel

Tino Rodriguez (Vol. 319, Pg. 663)
Existing 5.0 Acre Parcel

0517300002

Note: Reference is made to a survey by Gordon Geeslin in december 1976

Pierstorff Survey

State of: Ohio County: Mercer
 Township: Hopewell Sec: 17 Town: 5S Range: 2E
 City/Village: _____ Subdivision: _____ Lot: _____
 Deed Ref: O.R.186 Pg.2179 Date Surveyed: 12-27-07
 Approvals: _____ Board of Health _____ County Engineer _____
 Agency: _____ Township Zoning Inspector _____
 Date: _____

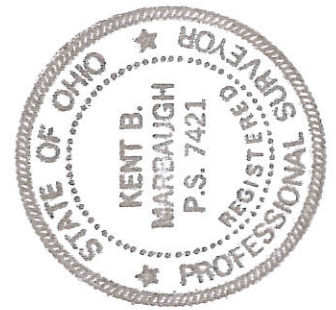

Marbaugh Land Surveying
 1901 Carolina Court
 Celina, Ohio 45822
 (419) 586-4293

Kent B. Marbaugh
 Kent B. Marbaugh P.S. 7421

0517400004 ; 0517460005/05-D

SURVEYED BY Gordon L. Geeslin
GORDON L. GEESLIN
REGISTERED SURVEYOR
No 5372

LEGEND

- "A" = HOLLOW TOOTH SPIKE FD.
- "B" = 1" IRON PIPE FD.
- "C" = CORNER POST.
- "D" = 5/8" IRON BAR SET.

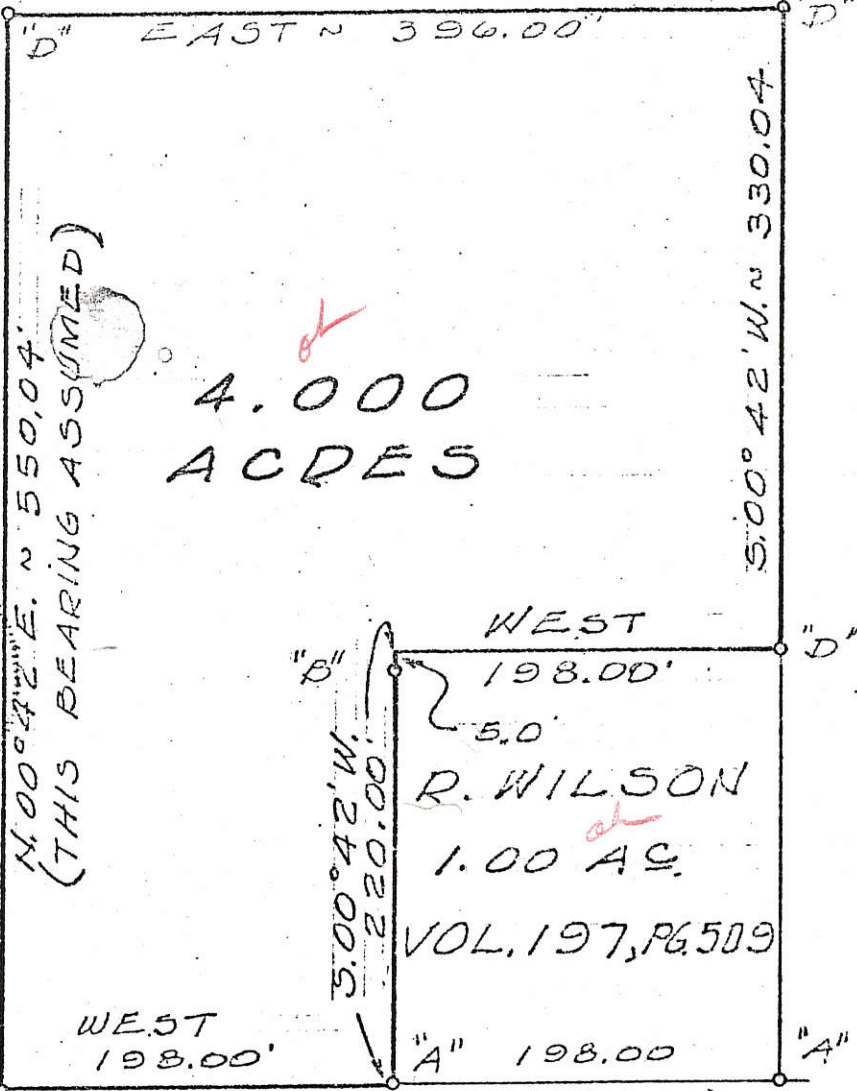
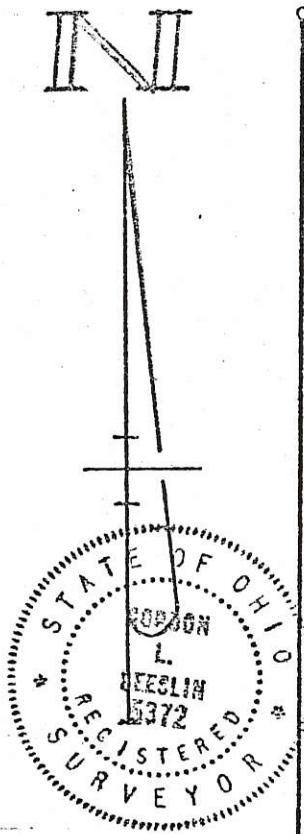

4.000
ACRES

R.R. SPK @ S.W.
COR. OF SEC. 17
S. 1/4 POST
OF SEC. 17 } 773.45
BY DEED }
3440.76 MEAS. } "E"

S. LINE ~ S.E. 1/4 ~ SEC. 17 & E FRAHM PK

WILSON SURVEY ~ PT OF THE S.E. 1/4
OF SECTION 17, TOWN 5 SOUTH, RANGE
2 EAST (HOPEWELL TWP.), MERCER
COUNTY, OHIO

31 MAY 4, 1978

SCALE 1" = 100'

0517400007

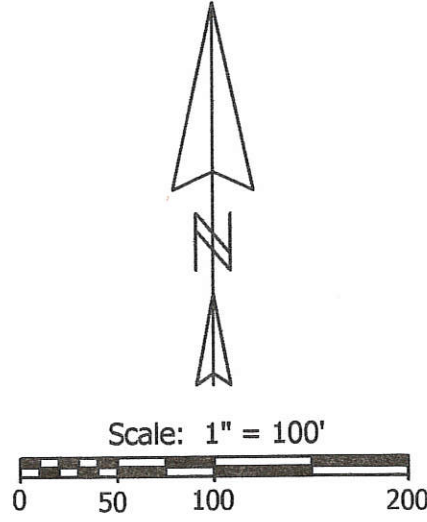
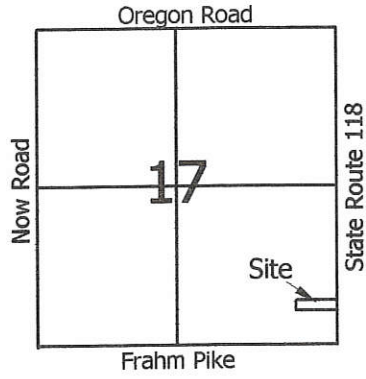

Legend:

- ▲ Cornerstone @ the E1/4 post of Section 17
- ▲ Cornerstone @ the SE corner of Section 17
- Mag nail set
- ⊗ Iron pin found (Thompson)
- 5/8" X 30" Iron pin w/cap set
- ⊗ 5/8" X 30" Iron pin w/cap set on line and 30.0' from corner

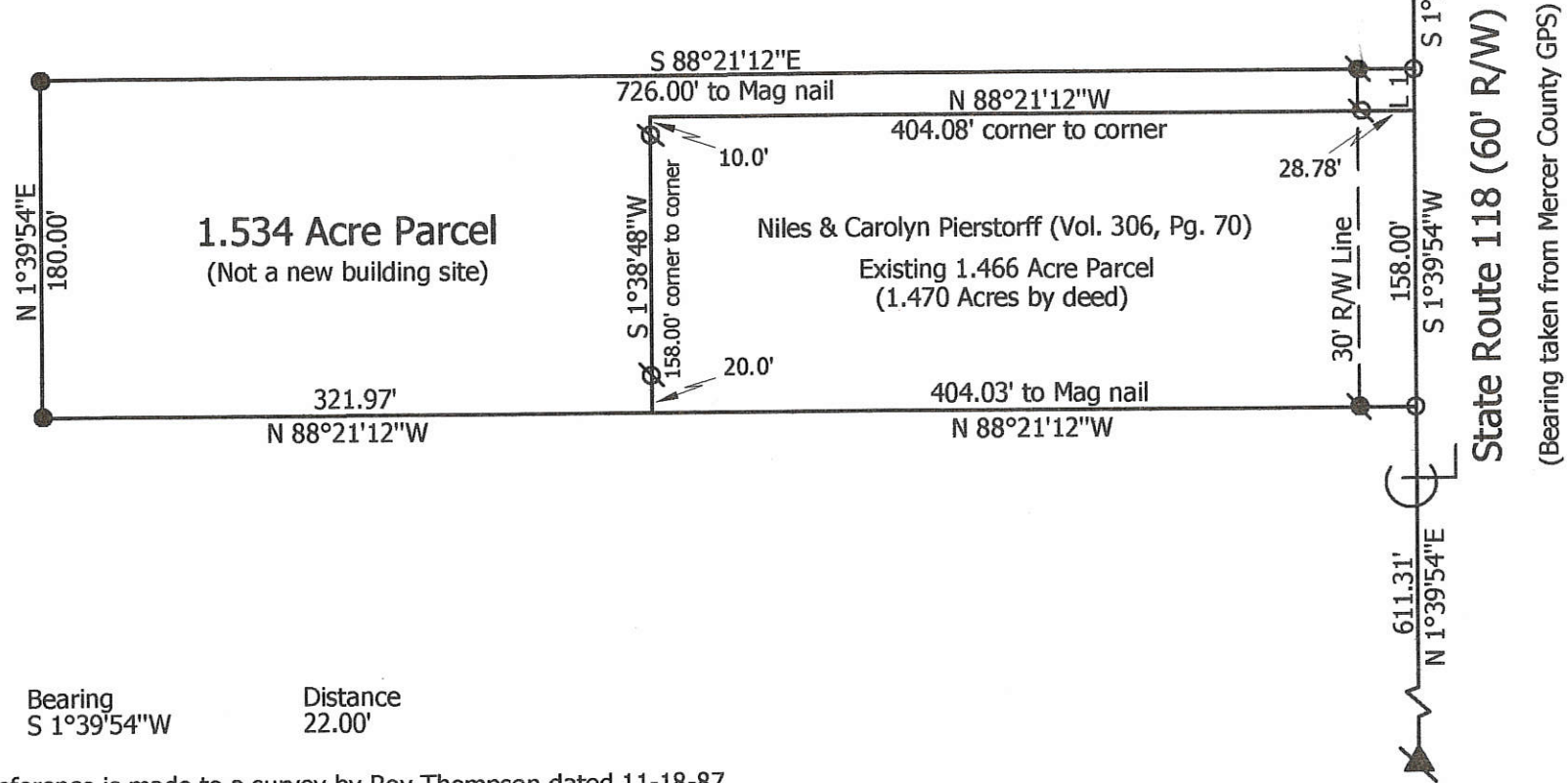

(Bearing taken from Mercer County GPS)

Line	Bearing	Distance
1	N 1°39'54"W	22.00'

Note: Reference is made to a survey by Roy Thompson dated 11-18-87

Pierstorff Survey

8571 State Route 118

State of: Ohio County: Mercer
 Township: Hopewell Sec: 17 Town: 55 Range: 2E
 City/Village: _____ Subdivision: _____ Lot: _____
 Deed Ref: O.R.186 Pg.2179 Date Surveyed: 2-28-07
 Approvals: _____ Date: _____
 Agency: _____ Township Zoning Inspector: _____ County Engineer: _____



Marbaugh Land Surveying

1901 Carolina Court
 Celina, Ohio 45822
 (419) 586-4293

Kent Marbaugh
 Kent B. Marbaugh P/S.7421

05-17-400-007

05-10 ✓

PIERSTORFF SURVEY

PART S.E. 1/4, SEC. 17, T55, R2E
HOPEWELL TWP., MERCER CO., O.

LOCATION PLAT.
SE 1/4, SEC 17, HOPEWELL TWP.

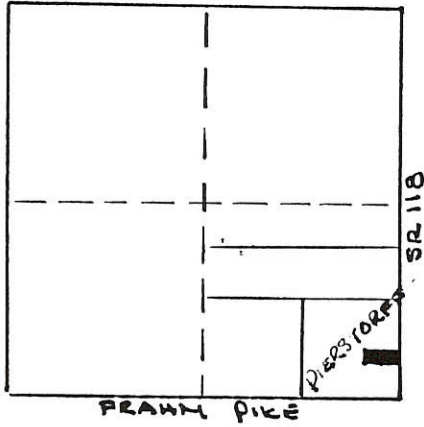

SCALE:
1" = 100'

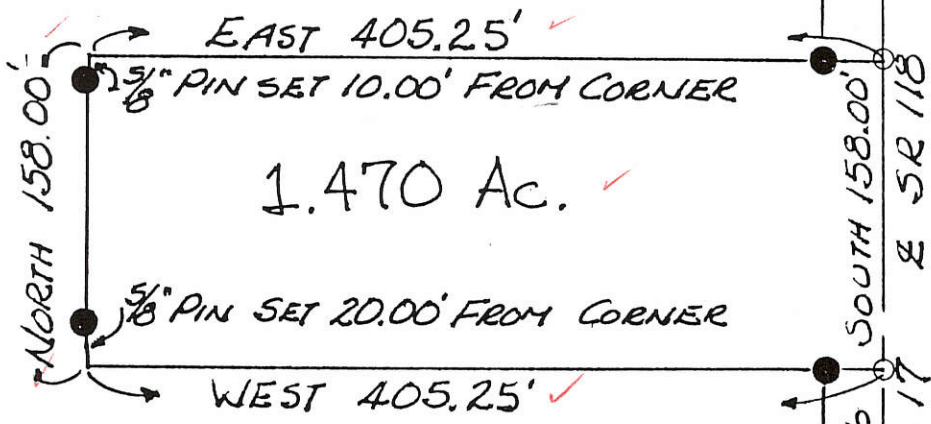

MERCER CO. ENGR.
Date 11/18/87 By JFW
REVIEWED

MERCER CO. ENGR.
Date 11/18/87 By JFW
RECEIVED

LEGEND:

- 5/8" ϕ IRON PIN SET
- MASONRY NAIL SET
- △ STONE CORNER

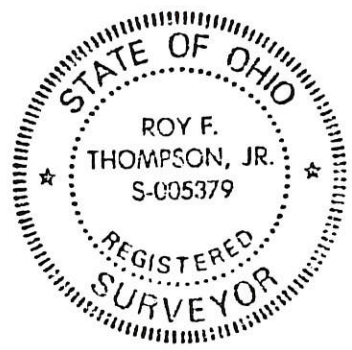

SOUTH LINE SEC. 17
& FRAHM PIKE

SR 118 (EAST LINE SEC. 17) USED AS
NORTH FOR ALL BEARINGS -

PLAT BY SURVEY 11-18-87

Roy F. Thompson, Jr.

ROY F. THOMPSON JR., REG. SUR. # 5379.

FILED IN SURVEY BOOK

S.E. COR. SEC. 17
STONE # 333

MERCER CO. ENGR.
Date 11/18/87 By JFW
REVIEWED

MERCER CO. ENGR.
Date 11/18/87 By JFW
RECEIVED

LINCOLN GRAPHIC CORP. 6405 10-11-15 500 8-44

LEGEND

- "A" = STONE @ W. 1/4 POST OF SEC. 17.
- "B" = CORNER POST @ CENTER OF SEC. 17 (DUG FOR STONE - FOUND NONE)
- "C" = RAILROAD SPIKE @ S.W. COR. OF SEC. 17.
- "D" = RAILROAD SPIKE FD. @ BENNETT'S N.W. COR.
- "E" = IRON PIPE FD. @ BENNETT'S N.E. COR.
- "F" = 3/8 INCH IRON BAR SET.
- "G" = RAILROAD SPIKE SET.

LOCATION SKETCH

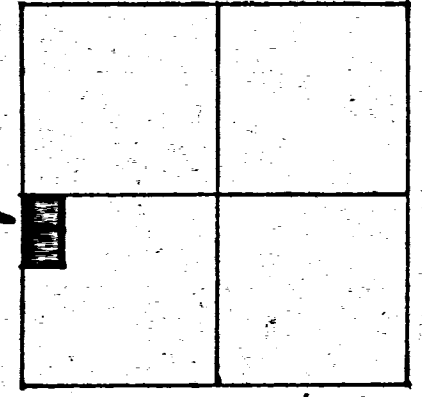

SECTION 17

NOTE:

THE N.E. CORNER OF TRACT "A" IS 6' ± SOUTH OF THE LINE OF OCCUPANCY. THERE IS, HOWEVER, A POSSIBILITY OF TITLE BY ADVERSE POSSESSION.

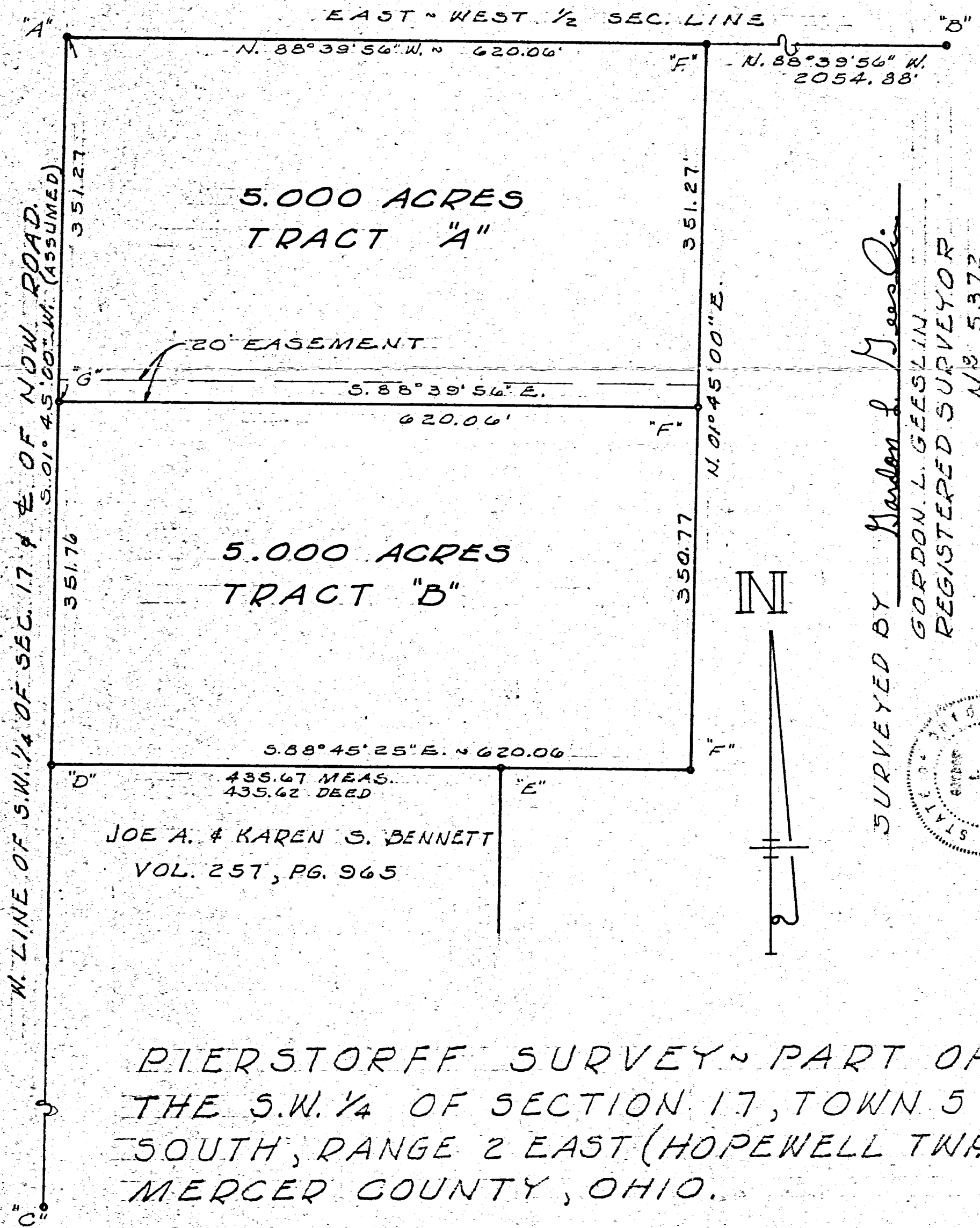

SURVEYED BY Gordon L. Geeslin
 GORDON L. GEESLIN
 REGISTERED SURVEYOR
 No. 5372

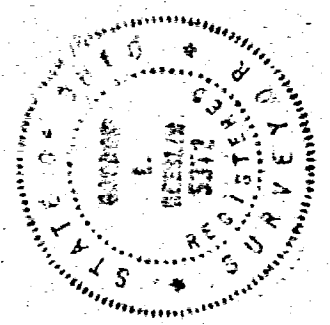

PIERSTORFF SURVEY - PART OF THE S.W. 1/4 OF SECTION 17, TOWN 5 SOUTH, RANGE 2 EAST (HOPEWELL TWP), MERCER COUNTY, OHIO.

DECEMBER, 1976

SCALE 1" = 100'

J. P. WILSON SURVEY
 SW 1/4 - SE 1/4 SECT. 17 - T. 5 S - R. 2 E
 HOPEWELL TWP. MERCER Co. OHIO.

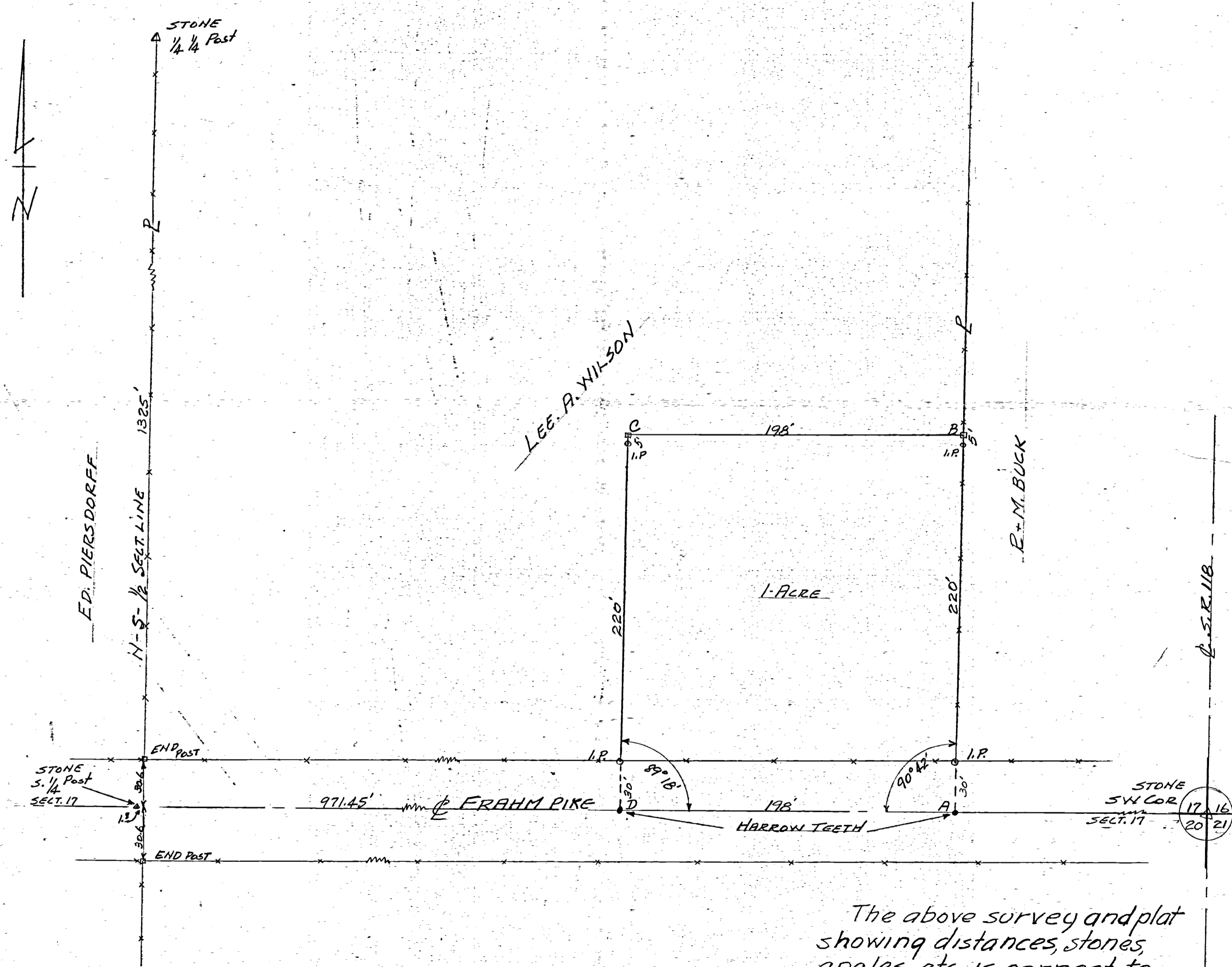

SCALE 1 INCH = 50 FT.

The above survey and plat showing distances, stones, angles etc. is correct to best of my knowledge.

April-1953

B.R. Gehhart
Regst. Sur. 3909

44

1870 Fred Frahm et al, Sec 17, T-5-S, R-2-E Hopewell Twp
Survey Bk 3, pg 44

MERCER COUNTY.

Plot Sec 17 T-5-S R-2-E Hopewell Sp.

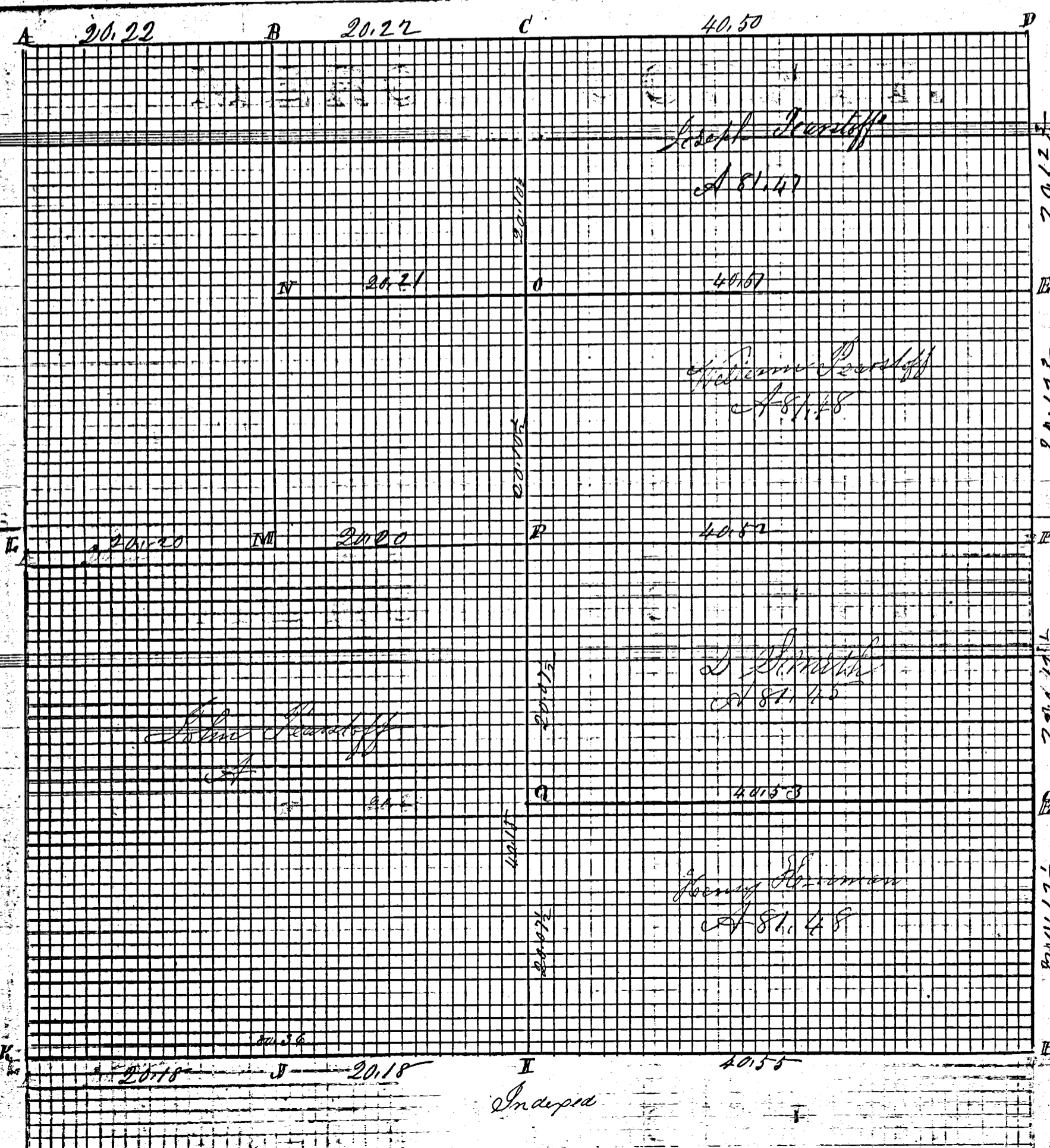

ROAD RECORD

Plot and notes of survey made by me in Section 11 Town 58 R28
 on the 6. 7. 8. 9th days of June 1870 at the instance of Frederick Frahm
 Charles Parstoff Lewis Smith William Parstoff Joseph Parstoff
 John Parstoff Henry Sumner and Frederick Sisk
 Chairmen Sworn John Parstoff and Charles Parstoff

- A Stone corner by me in former survey of Road
- B Stake to Stone 12. 9. 8 inches White Ash 4 x 2 9 8 36
- C W. P. I find stump of Hickory
 Stake to Stone 16. 12. 8 Road Oak 8 8 1 7 1/2 W 46
- D corner by me in former survey
- E Stone 12. 1. 2. 8 inches no trees
- F W. P. I find the stump of both Elm marked all correct with field notes
 Stake to Stone 16. 12. 6 not marked White Ash 3 x 4 3 8 4 4 6 (muddy) 72
- G Stake to Stone 18. 7. 6 inches no trees
- H Stone by me in former survey
- I I find White Ash corner tree standing green marked
- J Stake Road Oak 8 8 1 2 1/2 31
- K W. P. I find stump of Burr Oak 15 8 7 7 8 8 corner of 12 W Stake 12 6 4 4 6 lying down
 marked new Burr Oak 20 x 20 8 6 Burr Oak 20 8 14 8 36
- L W. P. I find W. Ash standing green stump of Elm
 Planted Stake to Stone 12. 9. 6 Elm 34 8 66 W 42 L
- M Stake to Stone 14. 8. 5 Burr Oak 18 8 5 6 1/2 8 5 1 Burr Oak 6 x 40 8 4 1/2
- N Stake to Stone 14. 8. 5 Beech 16 8 8 6 1/2 8 3 2 1/2
- O Stake and Stone 18. 8. 3 Beech 20 8 9 8 5 3 1/2 Beech 23 x 12 1/2 8 5 3
- P Stake and Stone 13. 9. 7 Beech 13 x 4 8 8 36 Sugar 20 8 9 4 8 3 9
- Q Stake and Stone 17. 12. 5 Black Ash 4 8 6 1 8 3 5 1/2 Elm 12 x 6 4 1/2 8 5 3

The above is correct to the best of my belief

May 9th 1870

M. Schuyler Co Sur

The above is copied by me from note Book no 15. Pages 76 and 77
 on this 9th day of May 1892 and is correct to the best of my belief

Marcus Schuyler Surveys

Compared

SURVEY No.

In Town 55 of Range 2E East. Plat and Notes of Survey made by me on the
 day of ~~21~~ D. 1836, in Sec. 16 ⁸⁻⁹ Town 55, of Range 2E; at the instance of
 the Mercer County Commissioners

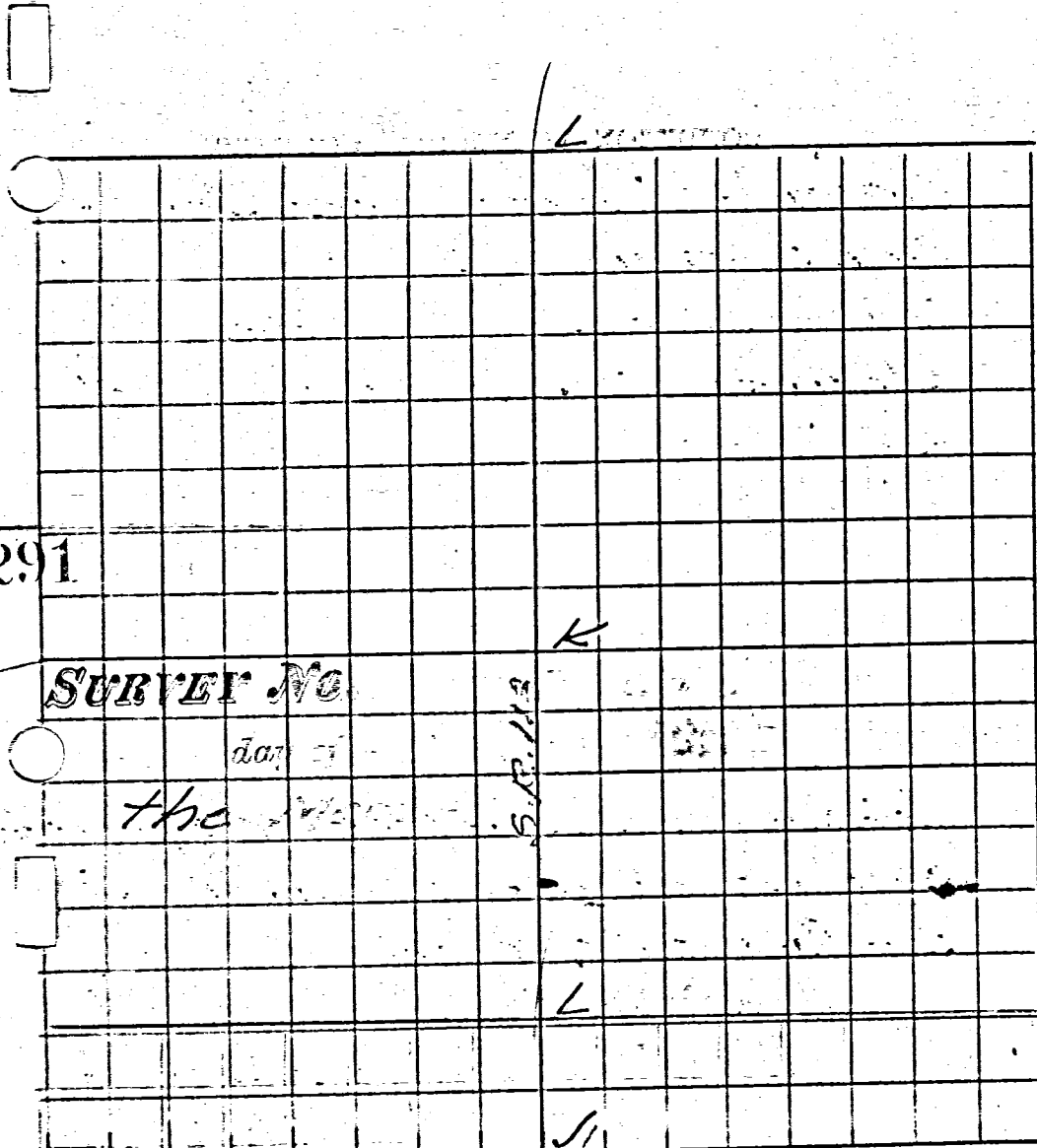

CONDITION OF ORIGINAL CORNERS.

Center Line - Rockford -
 Coldwater Rd.

Taken over by State Highway
 Dept. - 1936 - Right of Way - 60'

SURVEY No.

day of

the

S.P. 113

K
 L
 S

Note Bearings at (K) are ^{Survey inside of m. on the} wooden
 stakes (2" dia) with nail in stake.

All bearing stakes at (L) are 3/4" ϕ
 rods, 36" long, driven within 4"
 of surface of ground.

CONDITION OF ORIGINAL CORNERS.

Center Line - Rockford -

CORNERS DESCRIBED.	BEARING TREES.	D.	Course.	Dist.	BEARING TREES OR	Dist.
(J) Stone 6"x8"x12" found	SW 29'-4" SE 28'-14"	(J)	Described on Page 290	60	Driven along fences on N & S Ed.	
K Stone 6"x8"x14" found						
L Stone 6"x8"x14" found						
S (7' deep)						