

0423100004

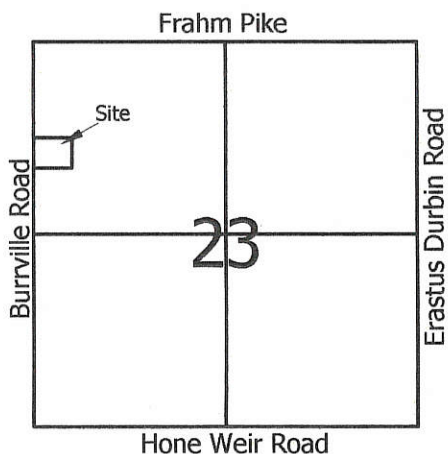

Legend:

- △ Cornerstone @ the W1/4 Post of Section 23
- ▲ Cornerstone @ the NW corner of Section 23
- 5/8" X 30" Iron Pin w/cap set
- Mag nail set

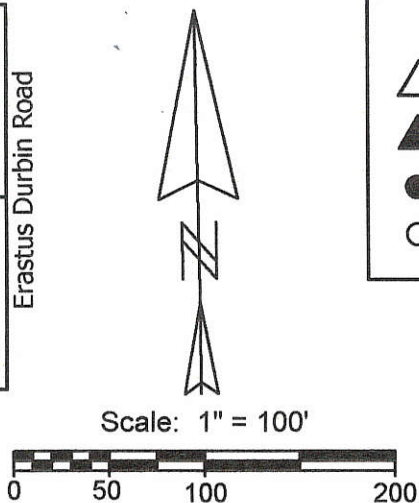

1 Lot
 Approved by the Mercer
 County Regional Planning
 Commission; no plat
 required under
 R.C. 711.133
Calder 4/25/13

Note: Cornerstones @ the East, North & South 1/4 posts of Section 23 were also used to determine the north line of this parcel.

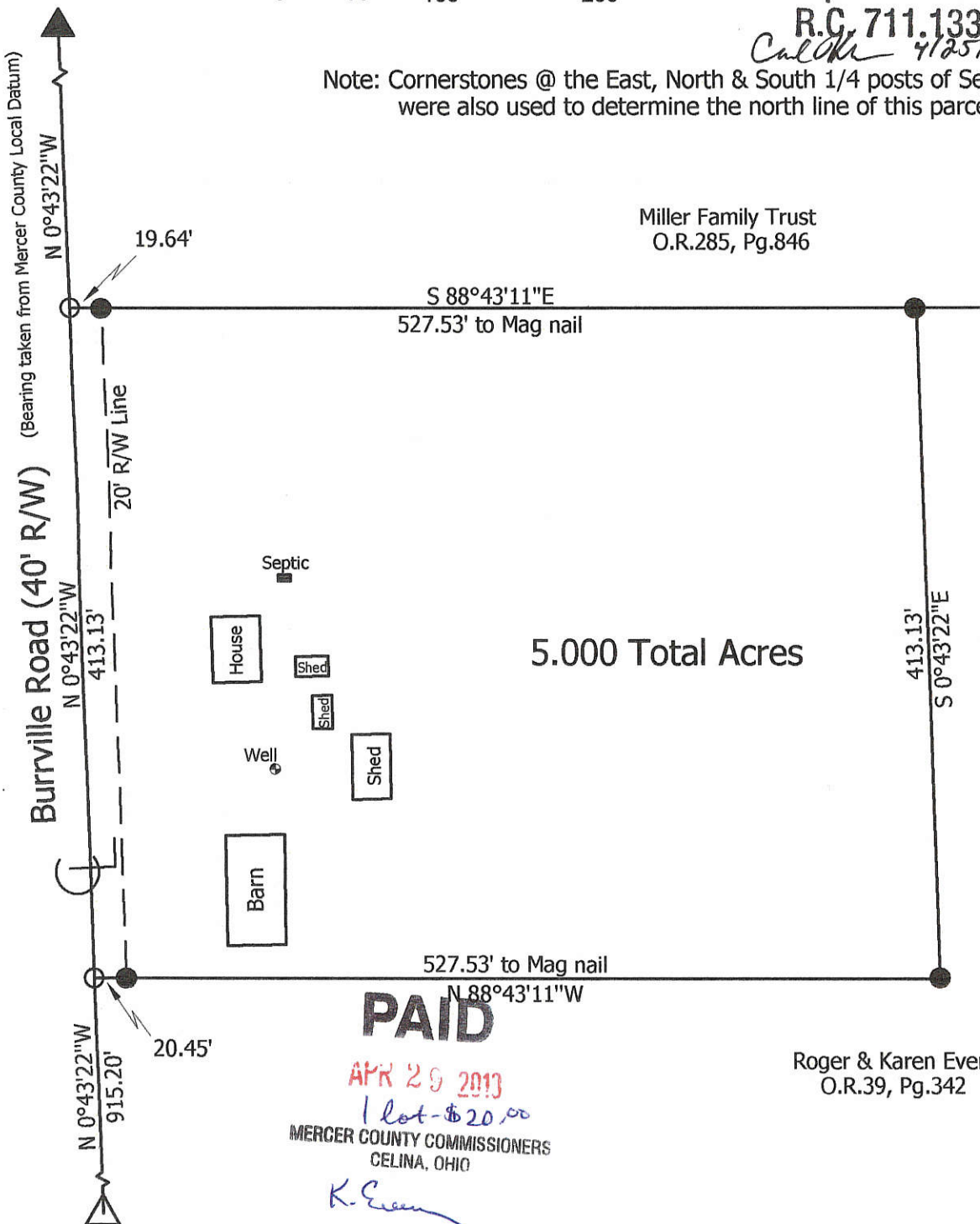

PAID
 APR 29 2013
1 lot - \$20.00
 MERCER COUNTY COMMISSIONERS
 CELINA, OHIO
K. Evers

**Marbaugh
 Land Surveying**

1901 Carolina Court
 Celina, Ohio 45822
 (419) 586-4293

Kent Marbaugh
 Kent B. Marbaugh P.S.7421



Roger & Karen Evers Survey
 8356 Burrville Road

State of: Ohio County: Mercer
 Township: Liberty Sec: 23 Town: 5S Range: 1E
 City/Village: _____ Subdivision: _____ Lot: _____
 Deed Ref: O.R.39, Pg.342 Date Surveyed: 4-5-13

Approvals: *[Signature]* *[Signature]* *[Signature]*
 Agency: Board of Health Township Zoning Inspector County Engineer
 Date: 4-25-13 4-24-13

04-F(23)

0423200001 04-F ✓

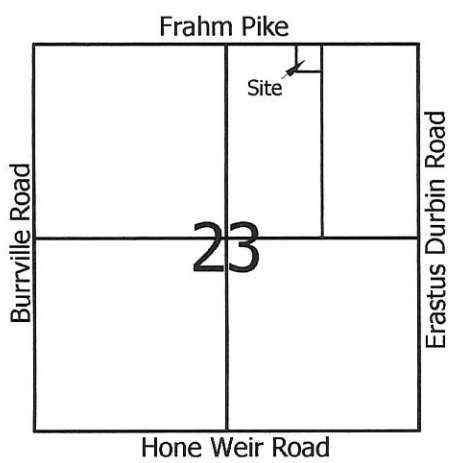

Legend:

- ▲ Cornerstone @ the N1/4 Post of Section 23
- ▲ Cornerstone @ the NE corner of Section 23
- 5/8" X 30" Iron Pin w/cap set on line and 25.00 feet from corner
- 5/8" X 30" Iron Pin w/cap set
- Mag nail set

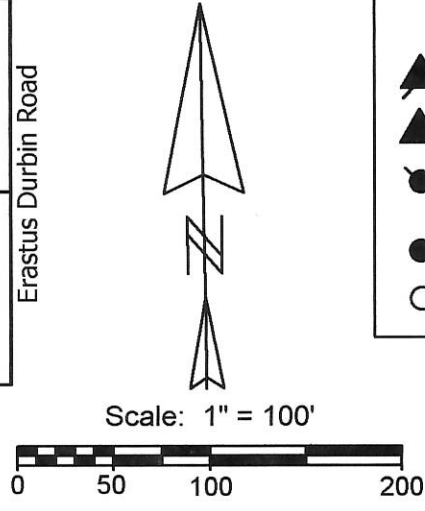

Note: Cornerstones @ the East, West & South 1/4 posts of Section 23 were also used to determine the east line of this parcel.

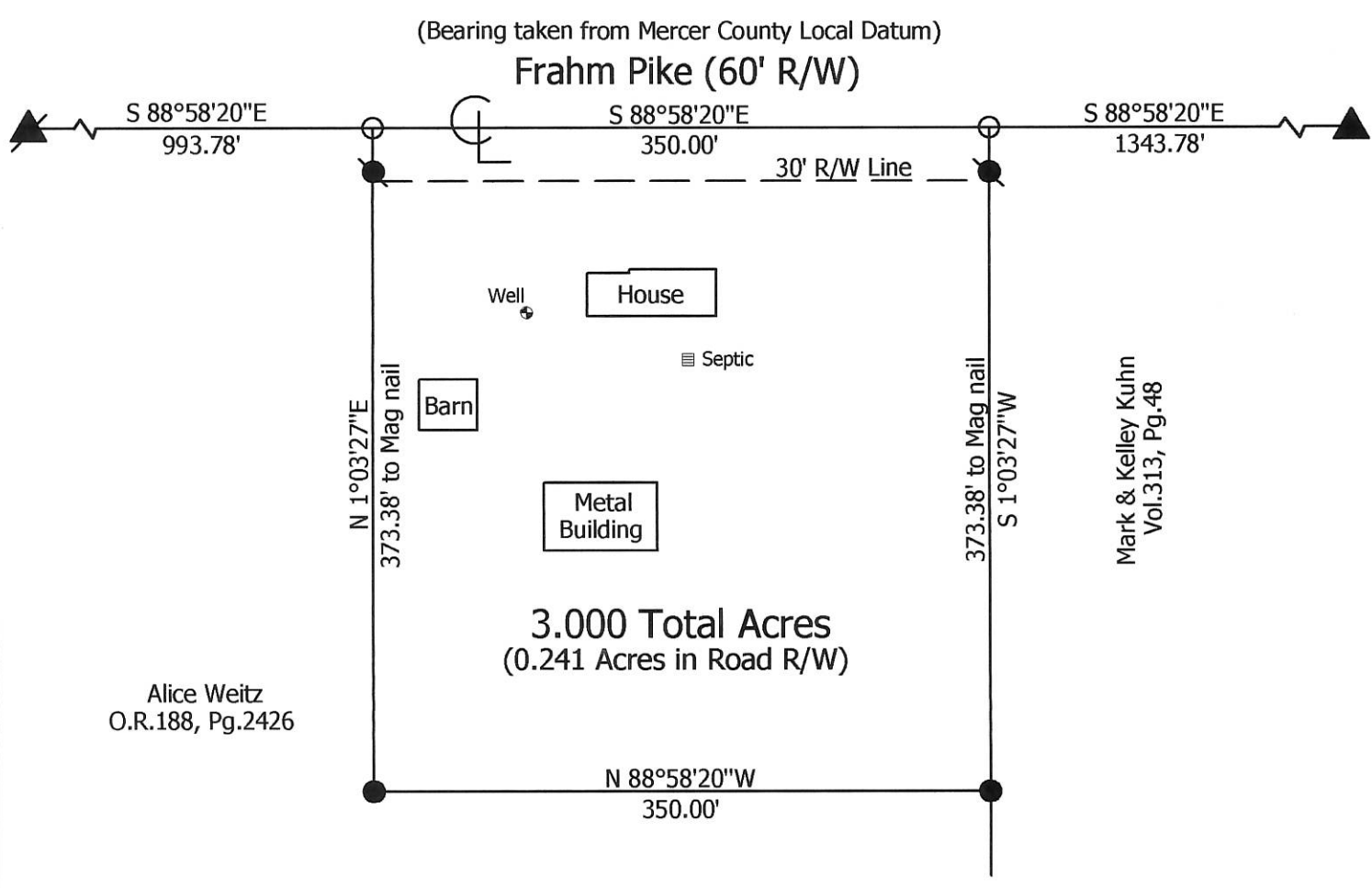

Marbaugh Land Surveying

1210 Yorkshire Court
 Celina, Ohio 45822
 (419) 586-4293

Kent Marbaugh
 Kent B. Marbaugh P.S.7421



Alice Weitz Survey
 2358 Frahm Pike

State of: Ohio County: Mercer
 Township: Liberty Sec: 23 Town: 5S Range: 1E
 City/Village: _____ Subdivision: _____ Lot: _____
 Deed Ref: O.R.188, Pg.2426 Date Surveyed: 11-26-04

Approvals: _____	_____	_____
Agency: Board of Health	Township Zoning Inspector	County Engineer
Date: _____		

KUHNS - SURVEY

PART NE 1/4, SEC 23, T55, R1E, LIBERTY TWP.
MERCER COUNTY, OHIO

LOCATION PLAT

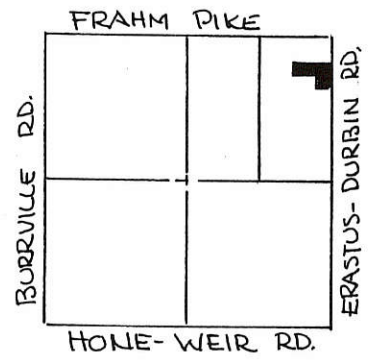

SEC 23-LIBERTY TWP.



SCALE:

1" = 50'

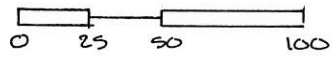

NORTH LINE SEC 23- FRAHM DK.

STONE # 209
NE COR SEC 23

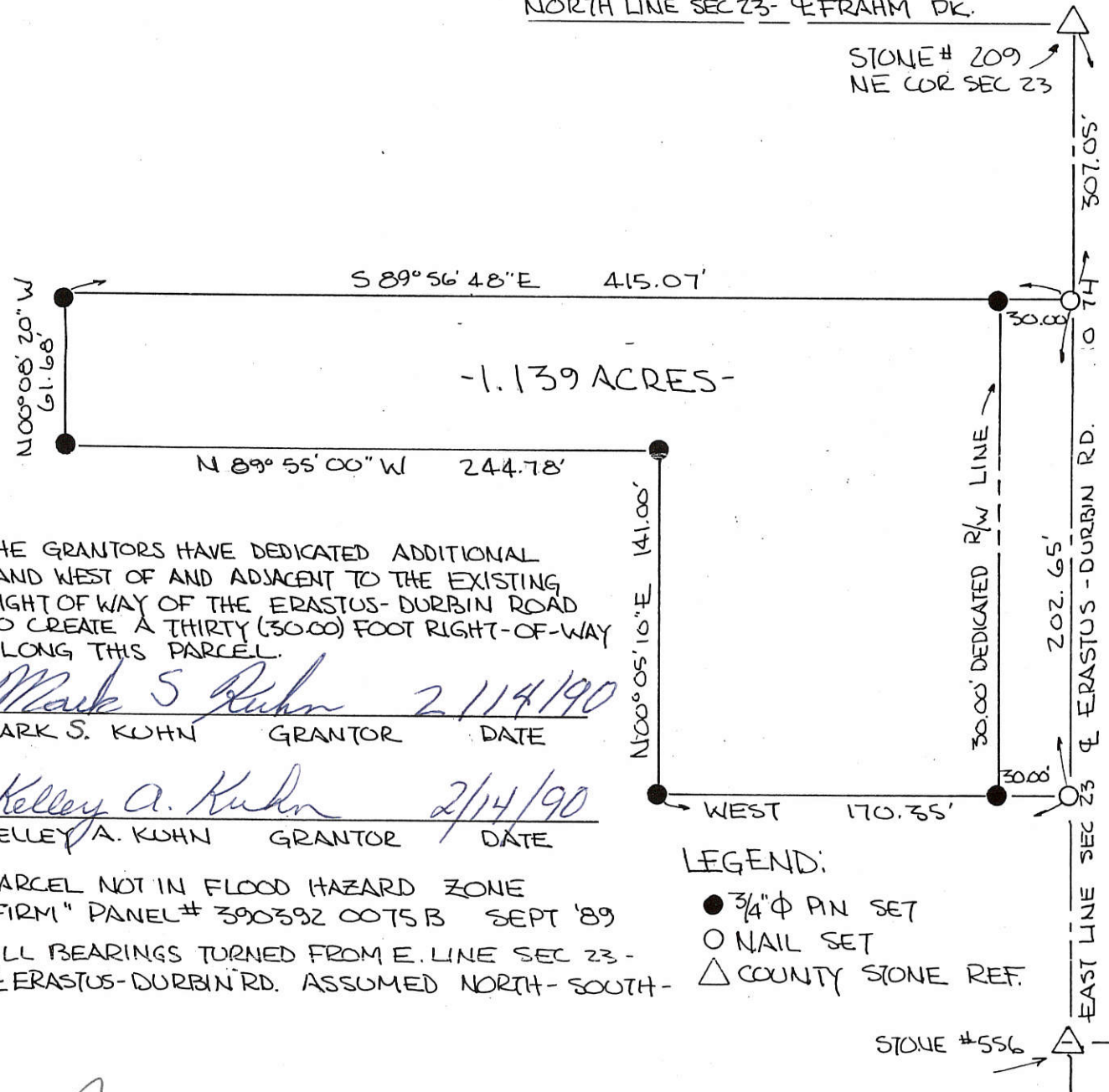

THE GRANTORS HAVE DEDICATED ADDITIONAL LAND WEST OF AND ADJACENT TO THE EXISTING RIGHT OF WAY OF THE ERASTUS-DURBIN ROAD TO CREATE A THIRTY (30.00) FOOT RIGHT-OF-WAY ALONG THIS PARCEL.

Mark S. Kuhn 2/14/90
MARK S. KUHN GRANTOR DATE

Kelley A. Kuhn 2/14/90
KELLEY A. KUHN GRANTOR DATE

PARCEL NOT IN FLOOD HAZARD ZONE
"FIRM" PANEL # 390392 0075 B SEPT '89
ALL BEARINGS TURNED FROM E. LINE SEC 23-
FRAHM RD. ASSUMED NORTH-SOUTH-

LEGEND:

- 3/4" φ PIN SET
- NAIL SET
- △ COUNTY STONE REF.

PLAT BY SURVEY JAN 1990
Roy F. Thompson Jr.
ROY F. THOMPSON JR. SUR.# 5379.

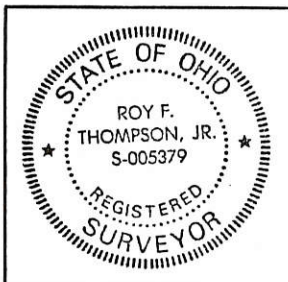

PERMANENT PARCEL No. _____	
Part of: <u>NE 1/4</u> Sec. <u>23</u> T <u>55</u> R <u>1E</u> LIBERTY Township	
Grantor: <u>KUHN</u>	Area Retained: <u>78.861</u> Acres
Grantee: _____	Area Transferred: <u>1.139</u> Acres
Deed References: _____	
APPROVALS: <u>Roy F. Thompson Jr.</u>	<u>John W. G... Co. Sanitary Engineer</u>
AGENCY: Board of Health	County Engineer
DATE: <u>9/23/1990</u>	<u>2-7-90</u>

"Original Signatures"

0423300001

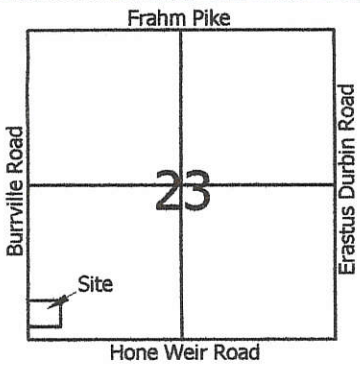

Legend:

- ▲ Cornerstone @ the SW corner of Section 23
- △ Cornerstone @ the W1/4 Post of Section 23
- 5/8" X 30" Iron pin w/cap set
- Mag nail set

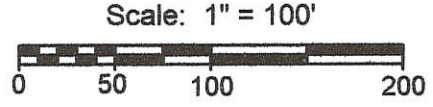

Carl [Signature]
 Approved by the Mercer
 County Regional Planning
 Commission; no plat
 required under
 R.C. 711.133

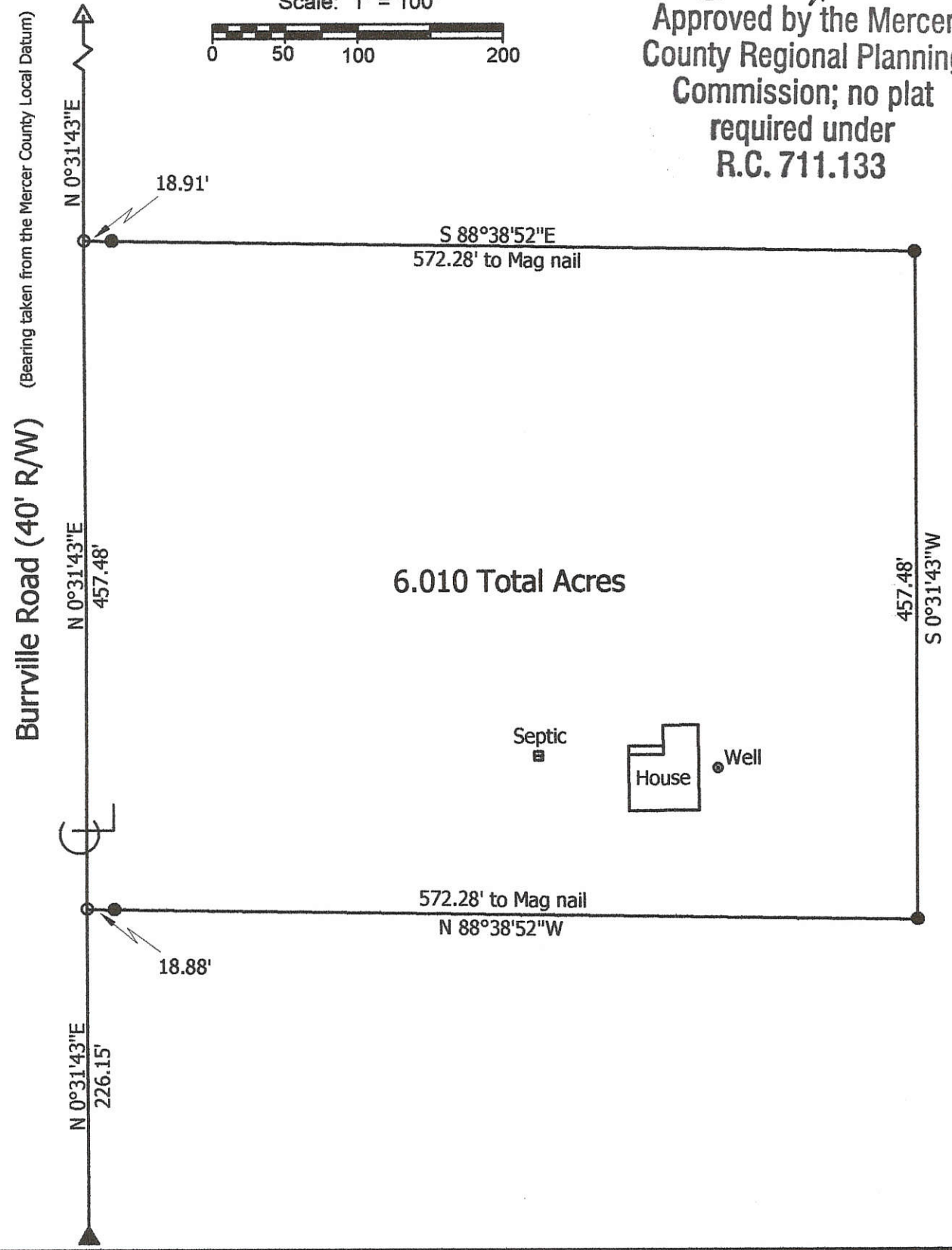

**Marbaugh
Land Surveying**

1901 Carolina Court
 Celina, Ohio 45822
 (419) 586-4293

Kent Marbaugh
 Kent B. Marbaugh P.S.7421



Stoner Survey
 8036 Burrville Road

State of: Ohio County: Mercer

Township: Liberty Sec: 23 Town: 5S Range: 1E

City/Village: _____ Subdivision: _____ Lot: _____

Deed Ref: Vol. 298, Pg. 334 Date Surveyed: 5-11-09

Approvals: *Chris [Signature]* *Howard County [Signature]* *Vernon Eickler [Signature]*
 Agency: Board of Health Township/Zoning Inspector County Engineer
 Date: 5-26-09 5-27-09

04-F(23)
 04-23-300001

0423200004

04-F ✓

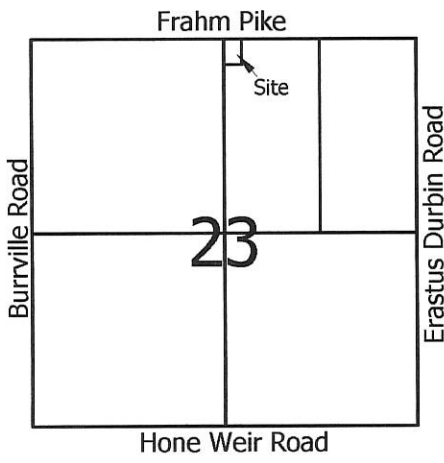

Legend:

- ▲ Cornerstone @ the N1/4 Post of Section 23
- ▲ Cornerstone @ the NE corner of Section 23
- 5/8" X 30" Iron Pin w/cap set on line and 25.00 feet from corner
- 5/8" X 30" Iron Pin w/cap set
- Mag nail set

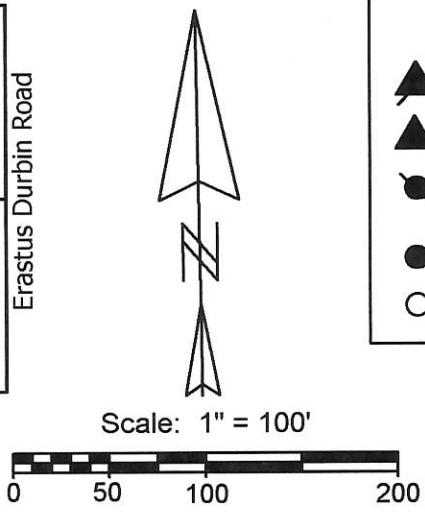

Note: Cornerstones @ the East, West & South 1/4 posts of Section 23 were also used to determine the west line of this parcel.

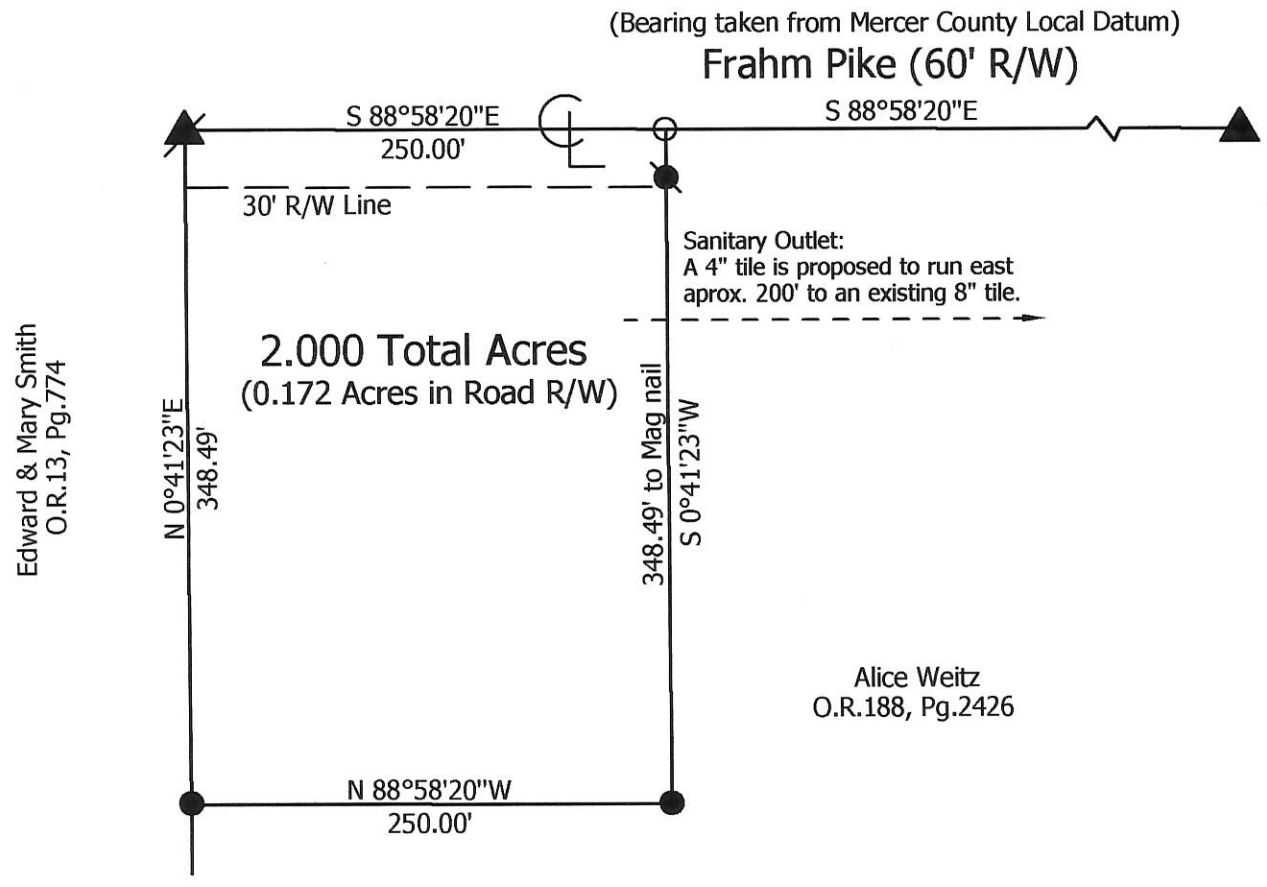

Marbaugh Land Surveying

1210 Yorkshire Court
Celina, Ohio 45822
(419) 586-4293

Kent Marbaugh
Kent B. Marbaugh P.S.7421



Alice Weitz Survey

State of: Ohio County: Mercer

Township: Liberty Sec: 23 Town: 5S Range: 1E

City/Village: _____ Subdivision: _____ Lot: _____

Deed Ref: O.R.188, Pg.2426 Date Surveyed: 11-24-04

Approvals: _____	_____	_____
Agency: <u>Board of Health</u>	<u>Township Zoning Inspector</u>	<u>County Engineer</u>
Date: _____	_____	_____

SURVEY OF A 2.510 ACRE PARCEL, A 4.092 ACRE PARCEL & A 7.404 ACRE PARCEL OF LAND FOR MARVIN AND MARY JO KOESTER

LOCATED IN THE S.E. 1/4 OF SEC. 23, T-5-S, R-1-E, LIBERTY TWP., MERCER CO., OHIO

04 23400004
04 23400 002

GEORGE & FRANCES STONER
DEED VOL. 239, P. 389
(66 AC. DEED)

OWNER: MARVIN & MARY JO KOESTER
DEED VOL. 293, P. 9

PARCEL "C"
7.404 ACRES TOTAL
-0.000 ACRES R/W
7.404 ACRES NET

PARCEL "C" IS NOT A BUILDING LOT. IT IS FOR RECREATIONAL PURPOSES ONLY

PARCEL "A"
2.510 ACRES TOTAL
-0.104 ACRES R/W
2.406 ACRES NET

PARCEL "B"
4.092 ACRES TOTAL
-0.110 ACRES R/W
3.982 ACRES NET

1 Lot
Approved by Mercer County Regional Planning Commission; No Approval or Plat Required under R.C. 711.133; FOR AGRICULTURAL AND PERSONAL RECREATIONAL USE ONLY.
Carl Thomas 7/26/11

2 Lot
MINOR SUBDIVISION
Approved No Plat Required For A Major Subdivision
7/26/11

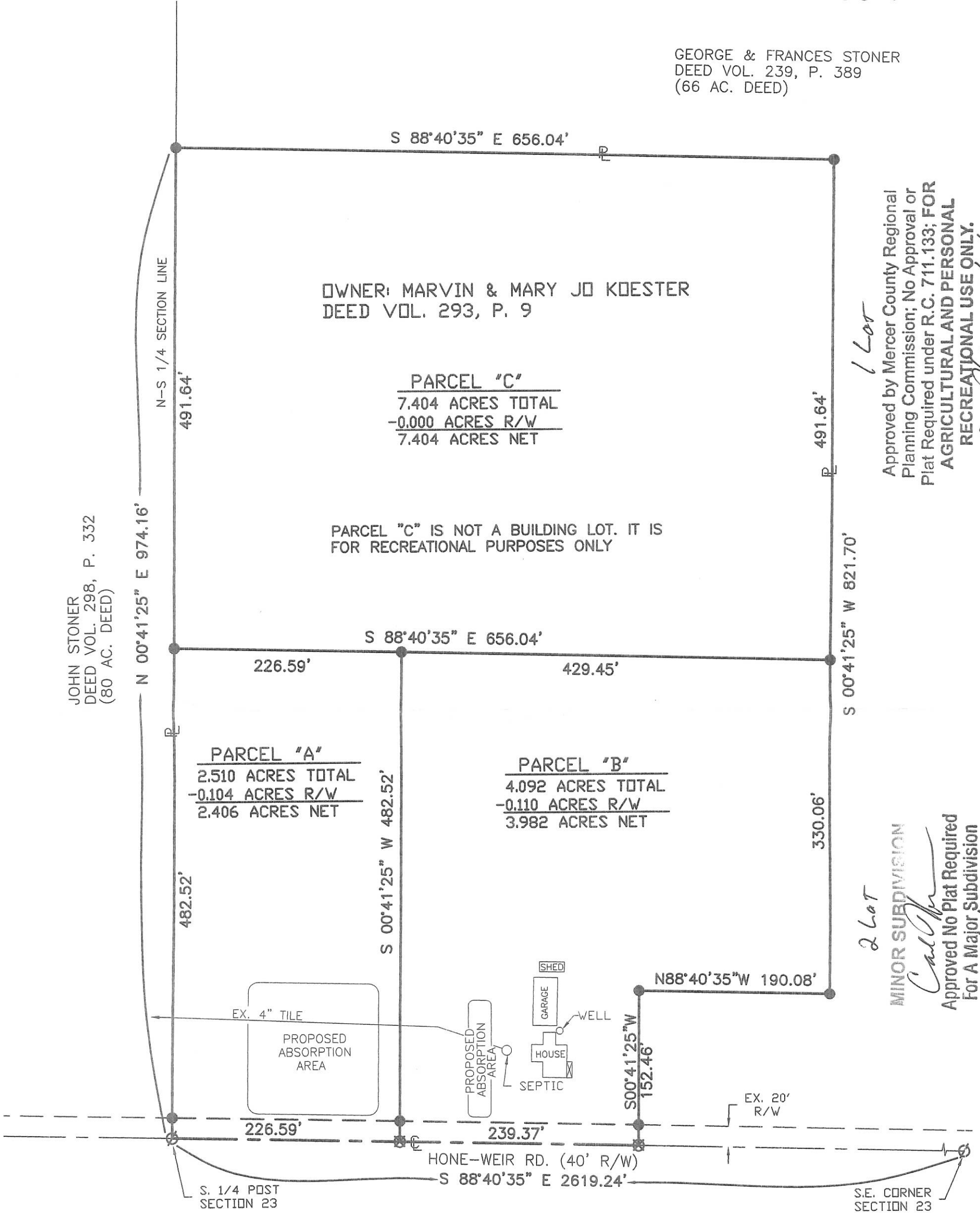

LEGEND

- Iron Pipe Found
- Iron Pin Set
- ∅ P.K. Nail Found
- ⊗ P.K. Nail Set

Surveyed By: *Eric C. Thomas*
Eric C. Thomas Reg. Surveyor No. 7236
Date: 7-12-11

References:
G.P.S. of Section Stones

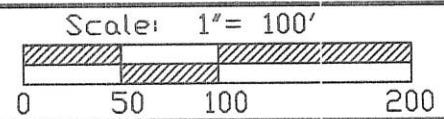

Part of S.E. 1/4 Sec. 23 T 5-S R 1-E LIBERTY Twp., Mercer Co., OH
Grantor: _____ Deeds: _____ Area Retained _____ Ac.
Grantee: _____ Area _____ Ac.

Approvals: *Eric C. Thomas* (Surveyor), *Donna Corbett* (Twp. Zoning Officer), *Demon Eickler* (Co. Engineer)
Agency: Bd. of Health Date: 7-25-11
Permanent Parcel No. _____

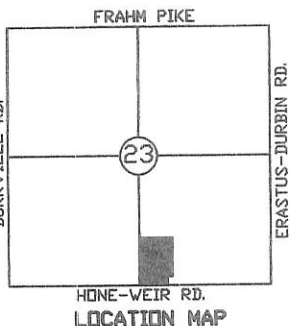

04-F(2)

MERCER COUNTY.

1. *Wm. Bowers*
 2. *Wm. Bowers*
 3. *Wm. Bowers*
 4. *Wm. Bowers*

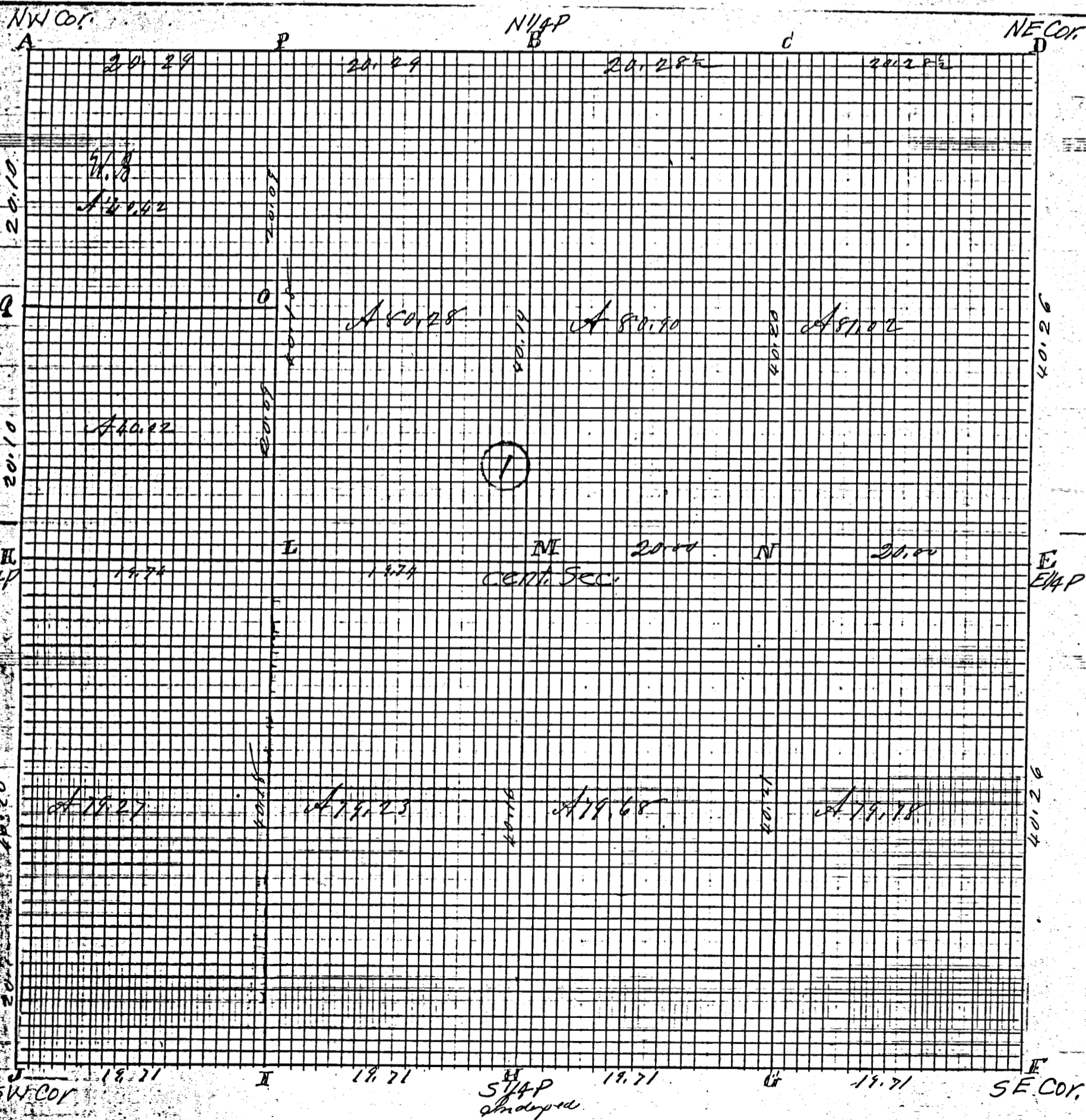

ROAD RECORD

①

Notes of Survey made by me in Sec 23 T55 R1E
on 13th Dec 1888 at the Inst of Wm Bowers & other
owners

- A Stone line 24.13.4 Elm 12 S 50 W 69 Stone Wit N 45 E 37 links
B Stake Beech green Black Ash 20 S 28 W 20
C Stone 10.8.6 Burr Oak 9 N 75 E 22 White Hickory 9 S 47 1/2 W 6 1/2
D Stake Stone 12.8.6 Black Ash 8 N 38 E 46 1/2 Sweet Oak 8 S 52 W 38
Burr Oak 12 N 19 W 95
E S. & Stone 13.9.8 Hickory 36 S 59 E 133 Beech 18 S 75 1/2 W 76
F S. & Cur of Sec in former sur
G Stake and Stone 13.8.6 no trees in sur of Sec 26 Dec 1877
H Stone 14.8.6 W Oak 8 S 69 E 44 1/2 Hickory 8 S 40 W 17
I Stake White Ash 11 N 6 E 19 White Ash 8 N 85 W 36
J Stone 32.12.8 Beech 20 N 75 E 23 Beech 16 S 46 W 115
K Stake and Stone
L Stake Elm 24 N 7 1/2 W 54 1/2 Beech 18 N 85 E 25 1/2
M center of Sec Stone 28.14.6 Burr Oak 8 West 26 1/4 Burr Oak 12 S 30 E 28
N Stones 24.13.9 Cottonwood 20 S 108 E 2 Maple 6 S 25 W 94 1/4
O Stone 9.6.6 Sycamore 16 S 33 W 25 Elm 10 S 68 E 8 1/2
P Stone Stone 20.10.6 Burr Oak 14 S 57 1/2 E 52 1/2 & no notes

The above notes of Survey were copied by me from note
Book no 22 Pages 200 and 201 and are correct to the
best of my knowledge and belief
Celina Aug 11th 1892

Comp.

Marcus Schuyler Surveyor

MERCER COUNTY.

145

1877 Henry Howe et al, Survey Blk 3, pg 145
SEC. 23 T 55. R 1E

LIBERTY TWP.

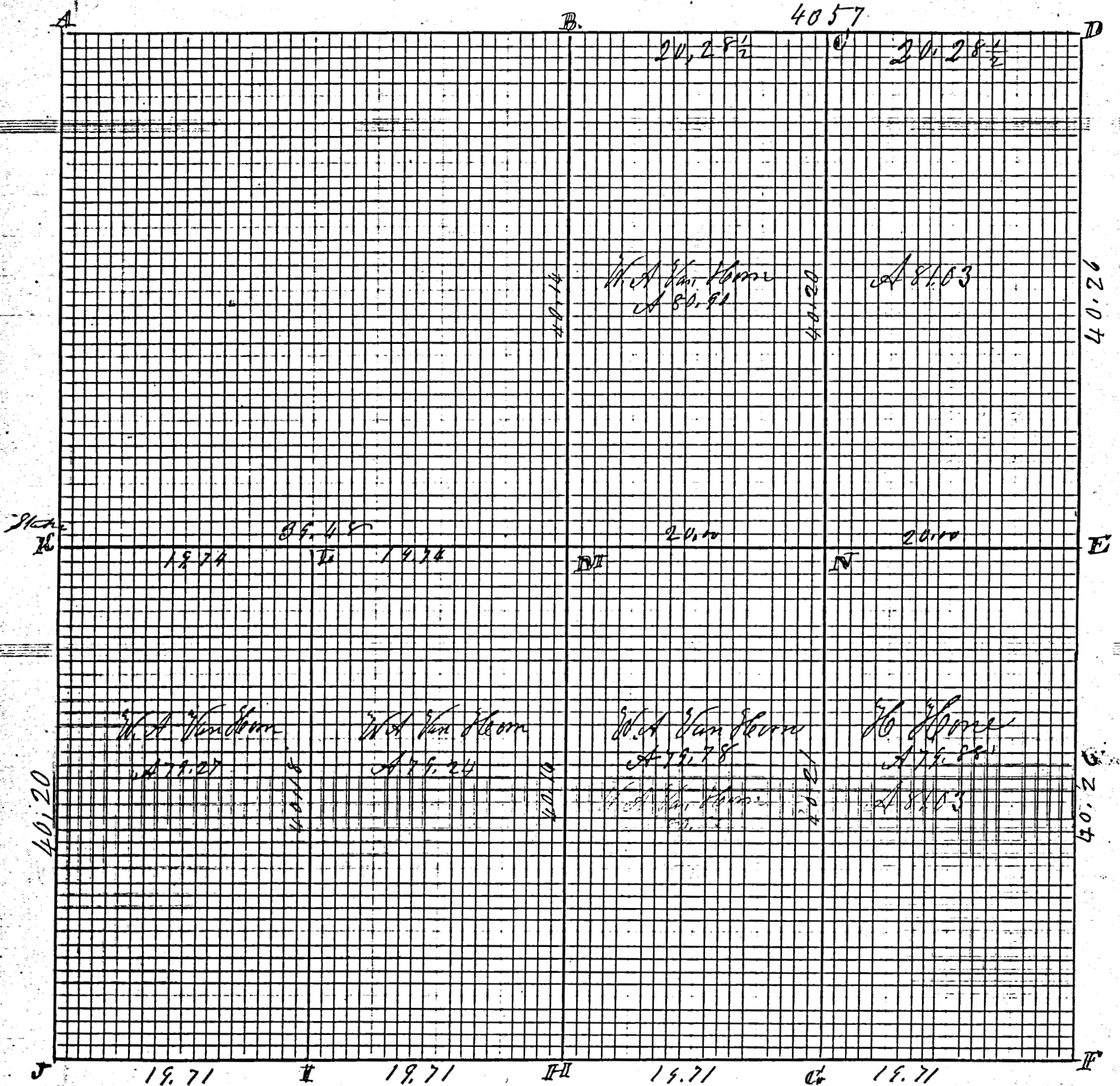

Sec. 23. T. 55 R. 16 Liberty Twp.

1877 Henry Hone et al, Survey Bk 3, pg 145

ROAD RECORD

Dec 23. S. 5 R. 16. Liberty Township
 Plat and Notes of Survey made by me in Dec 23rd 1877
 To 16 on the 19, 20 and 21 days of Dec 1877. at the instance
 of W. A. Van Horn and Henry Hone Chairman from
 Henry Hone and William Shortt

- A Stone at NW corner of Sec
- B N^o Post I find Beech standing green also roots of other
 stake Black Ash 20. 28 & 30
- C Stake Burr Oak 9 & 15 6 22 White Hickory 9 & 4 7 1/2 W 6 4 1/2
- D N E cor of Sec stake B Ash 8 & 38 6 4 1/2 Sweet Oak 8 & 5 2 W 3 8
- E Sand Stone 13, 9, 8 Old stump found, marked new
 Hickory 26 & 59 6 133 Beech 18 & 75 1/2 W 7 6 1/2
- F Stone corner in former line
- G Stone in survey in Sec 26 in trees at the Stone
- H S & Stone 14, 8, 6 in sur in Sec 26 W. Oak 8 & 6 9 6 4 4 1/2 Hickory 8 & 40 & 17
- I Stake W. Ash 11 N 6 & 19 White Ash 8 N 8 5 W 3 6
- J S Stone 32, 12, 8 Beech 20 & 75 6 23 Beech 16 & 4 6 W 11 5
- K Sd Stone 4-1888 Elm 24 N 7 1/2 W 5 2 3/4 Beech 18 & 85 6 25 1/2
- M Stake Stone 2 8, 14, 6 Burr Oak 8 West 2 6 7/4 Beech 12 & 70 6 28
- N Stake Stone 24, 13, 9 Cottonwood 20 & 10 6 8 2 Maple 6 & 29 W 9 4 1/2

The above notes of Survey I certify correct
 Liberty Dec 21st 1877. M. Schuyler Esq. Sur of Mercer Co. Ohio

The above notes of Survey were copied by me from Note Book
 no 19 Pages 229 and 230 and are correct to the best of my belief
 Belina June 17th 1892

Marcus Schuyler Surveyor

Camp

Survey No. 100. Plat and Notes of Survey made by me in the N.W. 1/4 of ~~Sec 10~~ Town 5 S. R. 1 E. on the 16th day of May A.D. 1867. at the instance of Sarah Ann Belton. Shari meit sworn Henry Smith and John Miller Jr. Scale 4 inches to a mile. Copied from Note Book No 6. Page 48.

183

N.W. corner of Section. I find both the Original bearing trees correct except Red Oak is 48 links distant from the corner instead of 42. as in Old Notes

B N 1/4 Post Stake

C E 1/4 Post. I find Beech 10 N 24 E 12 standing green marked also stump of Beech 15 S 17 W 25. marked Beech 18 S 39 1/2 W 40.

A 2030 F 2013 D

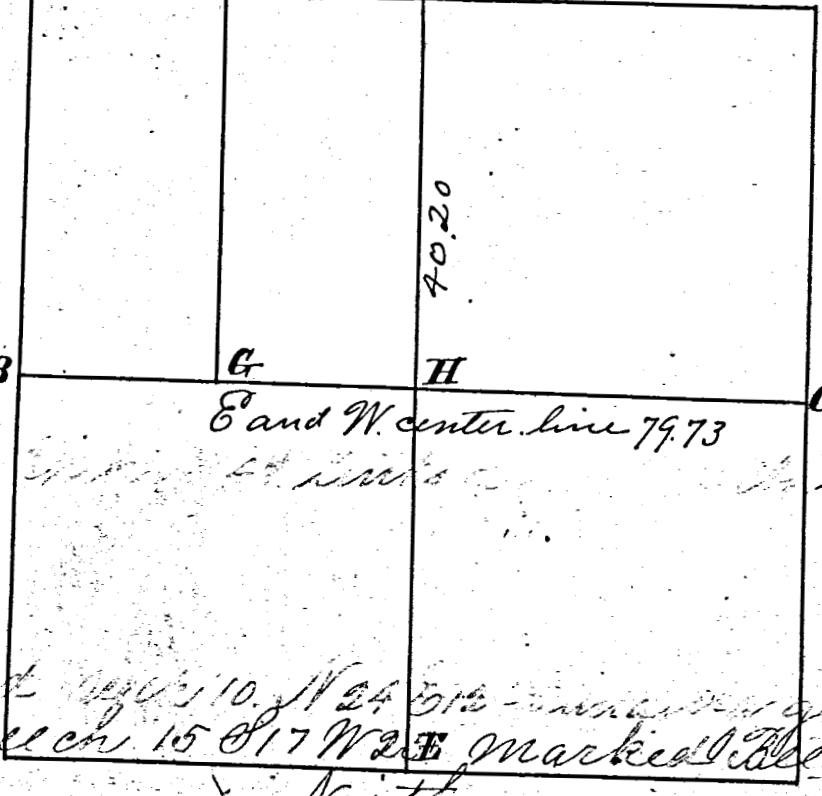

Survey Book 1

X

C E 1/4 Post. I find Beech 10 N 24 E 12 standing green marked also stump of Beech 15 S 17 W 25 marked Beech 18 S 39 1/2 W 40. North

D N 1/4 Post. I find the Beech 16. N 5 W 28 standing green and marked also the Stumps of Beech 12. S 20 E 35. all correct with notes. marked Black Ash 18. S 27 W 21. and drove a stake at corner

E E 1/4 Post not found. Stake left on line marked Maple 9 N 57 E 17 1/2

F on equal div of line Stake Elm 30 S 27 W 33. Hickory 7 S 15 E 52. Stake on corrected line 60 chs W. of E 1/4 Post.

H Stake on E and W. corrected line 40. chains from E 1/4 Post. of sec

The above as far as run and corrected. I certify is correct to the best of my knowledge and belief. Surveyor Office Lohia O. Feb 6th 1864.

Marcus Schuyler Surveyor

Receipt of J. M. Ford from field of Mercer County Ohio Record Nov 10th 1888.

183

Survey No. 100. Plat and Notes of Survey made by me in the N.W. 1/4 of Sec 23 Town 5. S. R. 1 E. on the 16th day of May A.D. 1861 at the instance of Sarah Ann Belin, Chaitmen sworn Henry Smith and John Miller Jr. Scale 4 inches to a mile. Copied from Note Book No 6. Page 48.

A N.W. corner of Section. I find both the Original bearing trees correct except Red Oak is 48 links distant from the corner instead of 42. as in Old Notes.

B 1/4 Post. Stake

C 3/4 Post. I find Beech 10. N 24 E 12 standing green marked also the Stump of Beech 15 S 17 W 25. marked Beech 18 S 39 1/2 W 40. North.

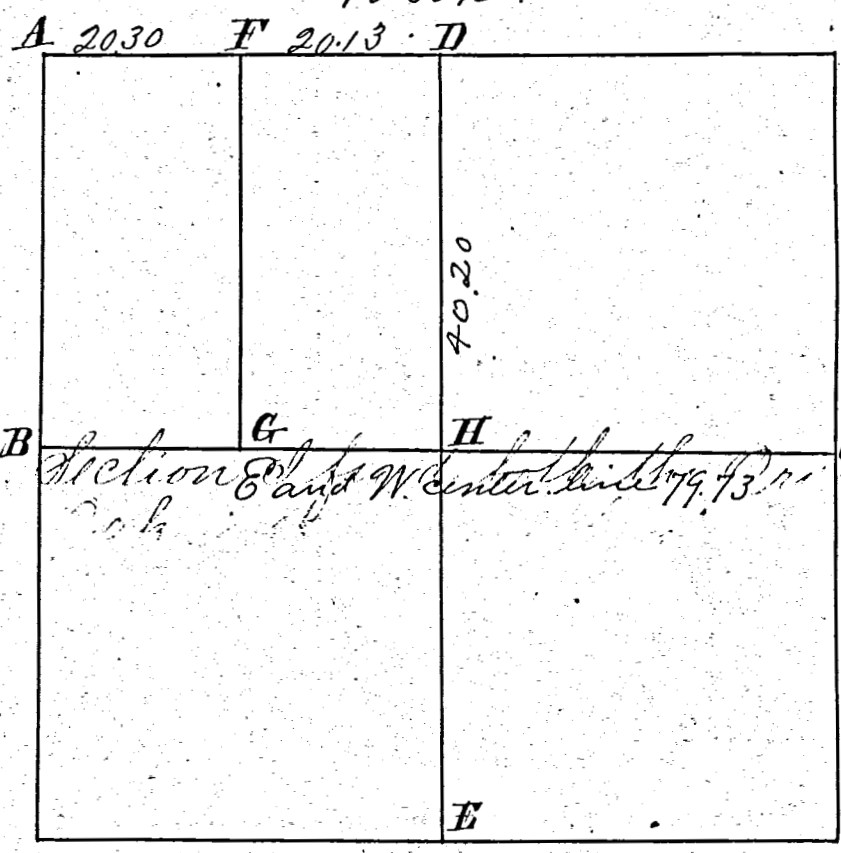

A N.W. corner of Section and W. center line by 79.73. Original bearing trees

D 1/4 Post I find the Beech 16. N 5 W 28 standing green and marked also the Stumps of Beech 12. S 20 E 35. all correct with notes. marked Black Ash 18. S 27 W 21. and drove a Stake at corner

E 3/4 Post not found. Stake left on line. marked Maples 9 N 57 E 17 1/2

F on equal div of line Stake Elm 30 S 27 W 33. Hickory 7 S 15 E 52

G Stake on corrected line to the W of E 3/4 Post.

H Stake on E and W. corrected line 40. chains from E 3/4 Post of Sec

The above as far as run and corrected. I certify is correct to the best of my knowledge and belief. Surveyor Office Lohia O. Feb 6th 1864. Marcus Schuster Surveyor of Merck County Ohio

Recopied by J. M. Ford from old Record Nov. 10th 1888.

MERCER COUNTY, 242

May 29th 1888 Survey made by me in the N E corner of the N W 1/4 of fractional Sec 30 S 7 S R 3 E at the Instance of Anthony Stetzer
 A Stone on stone corner N E corner of Brick Store house S 36 W 50 Links
 B Sd Lime Stone 12.9.4 being 10 rods or 22 chains West of A The N 1/4 Post of Sec 30
 C Sd Stone 15.9.4 1 chain West of B in Mill Pond 2 chains South of and 1 ch West of B
 D Sd Stone 20.11.4 inches The above is correct May 30th 1888 Marcus Schuyler Surveyor
 Copied by me from Note Book 22 Page 222 Aug 11th 1892 Marcus Schuyler Surveyor

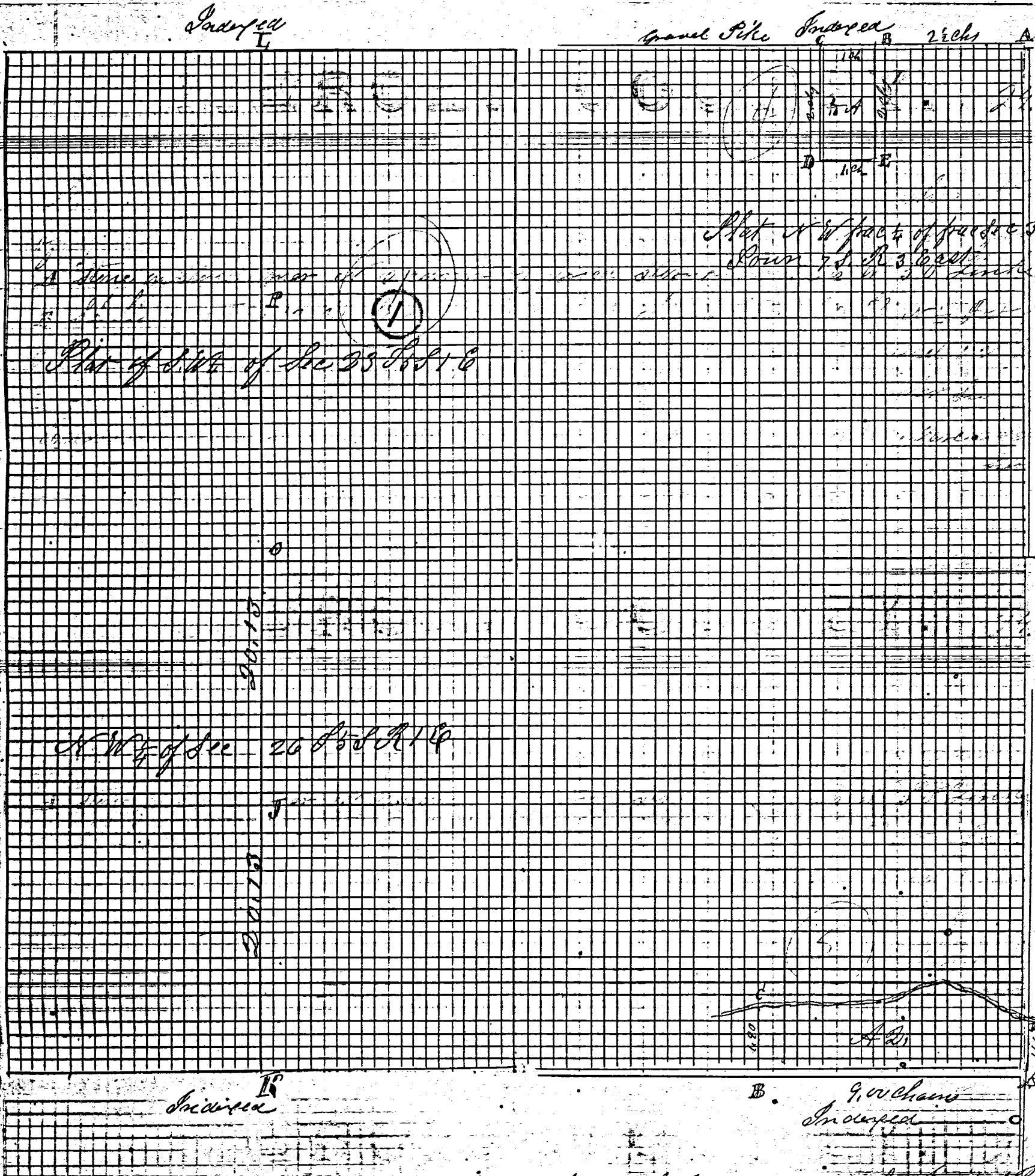

Plot of S.W. 1/4 of Sec 30 S 7 S R 3 E

Plot N W 1/4 of fractional Sec 30 S 7 S R 3 E

N W 1/4 of Sec 20 S 7 S R 1 E

Plot and notes of survey made on the 20th day of July 1888 at the request of Philip Laoy in the S E corner of Sec 13 S 7 S R 2 E the south bank of the ditch being the north line
 A S E cor of Sec in gravel pike Sd Stone 17.6.4 Burr Oak 28.8.5 22 W 149 Sd markers
 B Sd Stone 17.6.6 pointing dark log Burr Oak 24 S 26 E 66 1/2 Burr Oak 20 S 64 W 110 1/2
 C Sd Stone 15.10.7 Cottonwood 12 N 19 S 24 1/2 link West tree D Stake 100 rods of A
 Copied from Note Book 22 Page 224 The above is correct
 Celina Aug 13th 1892 Marcus Schuyler Surveyor

ROAD RECORD

①

T
O
P
J
K
H

That of S.W. 1/4 of sec 23 T 55, R 1 E as surveyed by me
 April 12th 1888 at the instance of J. J. Trissel
 S line Stone 20.12.4 Elm 24 N 71 1/2 W 54 3/4 Bush 18 N 85 E 25 3/4
 S. L. Stone 32.8, 2 1/2 White Oak 188 38 E 47 D 148 31 W 46
 Stone 10.7.5 wish grey in Prairie at center of line
 Apr 13th 1888 M Schuyler Surveyor

S and Stone 15.10.4 White Oak 16 N 60 1/2 W 39 White Oak 38 75 E 19 1/4
 State Lime Stone 20.16.2 Elm 68 34 E 21
 Stone on South line of Sec 26 at the center of the West end
 of said line or at center of the 1/4 as on note fork the line
 is 40 66 chs being 20.33 chains each Planted a Stone Witness
 Lime Stone 20.12.3 50 links north of corner

The above is correct to the best of my belief
 The above notes April 15th 1888 M Schuyler
 of Survey, were copied by me from note Book
 Pages 215 and 216 and are correct

Belina Aug 11th 1892 Marcus Schuyler Surveyor
 in season of Belina M Schuyler Surveyor

Aug 17th 1889 At corner of Warren and Sugar Streets
 in grading for side walk, by order of Town Council fixed
 grade 9 inches below grade stone at Warren & Walnut
 Stone and grade as fixed (Chs) At S W corner same
 fixed grade 6 inches lower. At J Gilbert corner
 of Warren and Mill Street South East corner fixed grade
 7 inches lower than grade stone. At S. E corner of
 Anthony and Sugar to fix grade 10 inches lower and
 and to remain same at Alley Stetzers corner

Copied from Book 23, Page 52
 Belina Aug 27th 1892 M Schuyler Eng

Notes in sec 11 S 6 E R 2 E Survey made at the instance of
 C. D. Kirshner at the angle of the gravel Pike being at
 the center of the South end of the East line I planted
 a bowler over and against a lime stone corner Stone 14.9.8
 Red Oak 14 18 E 45 L. 20 chains West at the center
 of S. E 1/4 of Sec 11 I planted Stone in center of Pike
 and another Bowler in the line about 22 1/2 feet north
 of center of Pike on line between the N E and N W 1/4
 of said South East 1/4 Stone 16.8.4 inches Red Oak 6 East 1/2
 of Stone not marked the East and West line being
 directed being more 40 chains

The above is correct to the best of my belief

242

Indexed

Indexed