

PLAT OF SURVEY

EXISTING REBAR & CAP
NW COR NW 1/4
SECTION 15
MCLCD 3099

SHELLY ROAD

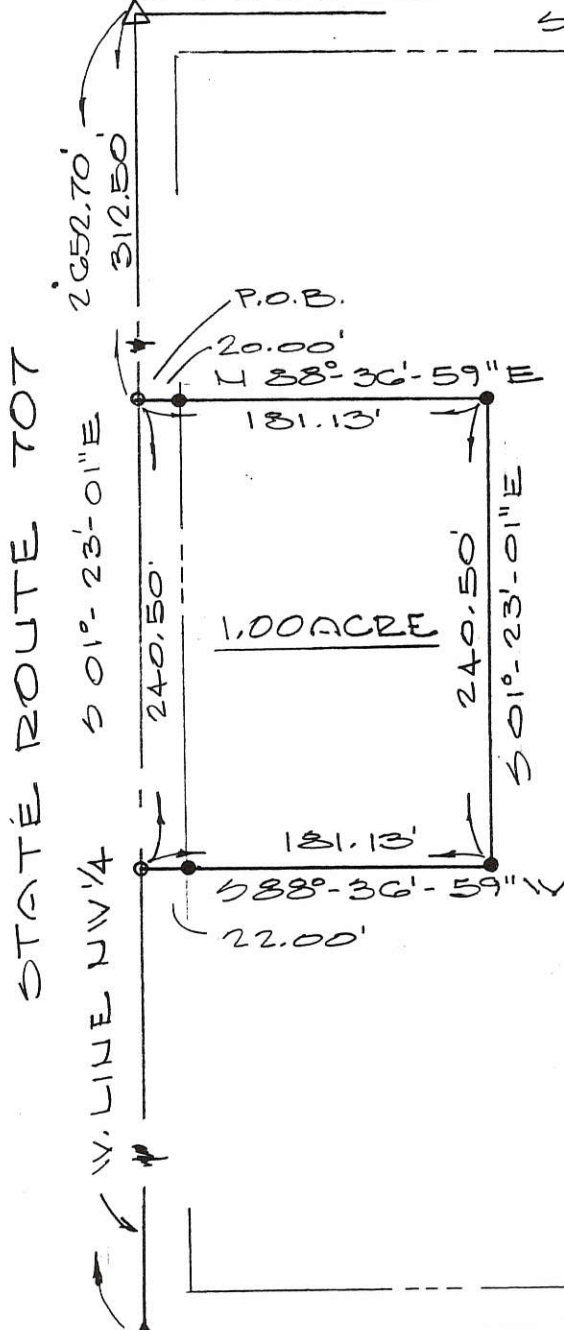

PHYLLIS O'NEILL
104.81 AC

NOTE: AREA IS AN
EXISTING BUILDING SITE.

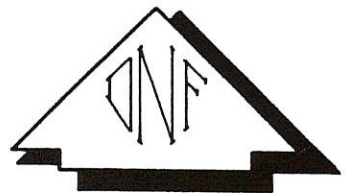

LEGEND

- MAG NAIL SET
- 5/8" ϕ REBAR & CAP SET



Deed Book OR 115 Page 5 MERCER Co. Recorder's Office

Bearings shown hereon are to an assumed meridian and are to denote angles only. BEARING W. LINE NW 1/4 501°-23'-01"E SCALE IN FEET

PART OF THE W 1/2 NW 1/4 OF SECTION 15, T-4-S, R-3-E,
UNION TOWNSHIP, MERCER COUNTY, OHIO

DATE OF SURVEY: 05/02/2001

THIS SURVEY WAS MADE AT THE
REQUEST OF:

PHYLLIS O'NEILL
7624 HAMILTON ROAD
MENDON, OHIO 45862

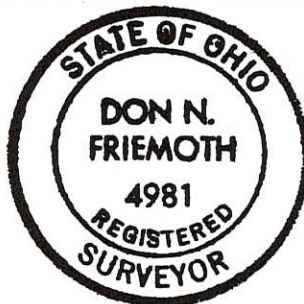

DATED THIS 3RD. DAY

OF MAY, 2001.
Don N. Friemoth
DON N. FRIEMOTH, P.S.
REG. PROF. SURVEYOR #4981
10637 MENDON ROAD
VAN WERT, OHIO 45891

LEGEND

- "A" = RAILROAD SPIKE AT N.E. CORNER - SECTION 15. (COUNTY STONE NO. 677.)
- "B" = P.K. NAIL FD. @ E. 1/4 POST N.E. 1/4
- "C" = CONG. CORNER POST USED.
- = P.K. NAIL SET.
- = 5/8" x 30" IRON BAR SET

LOCATION SKETCH

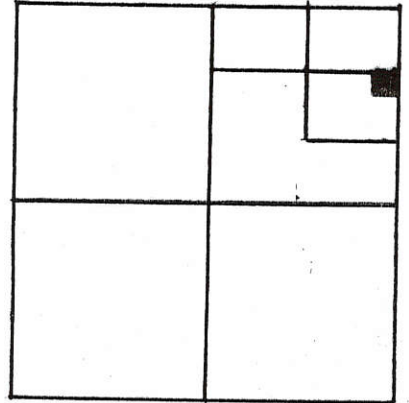

SECTION 15

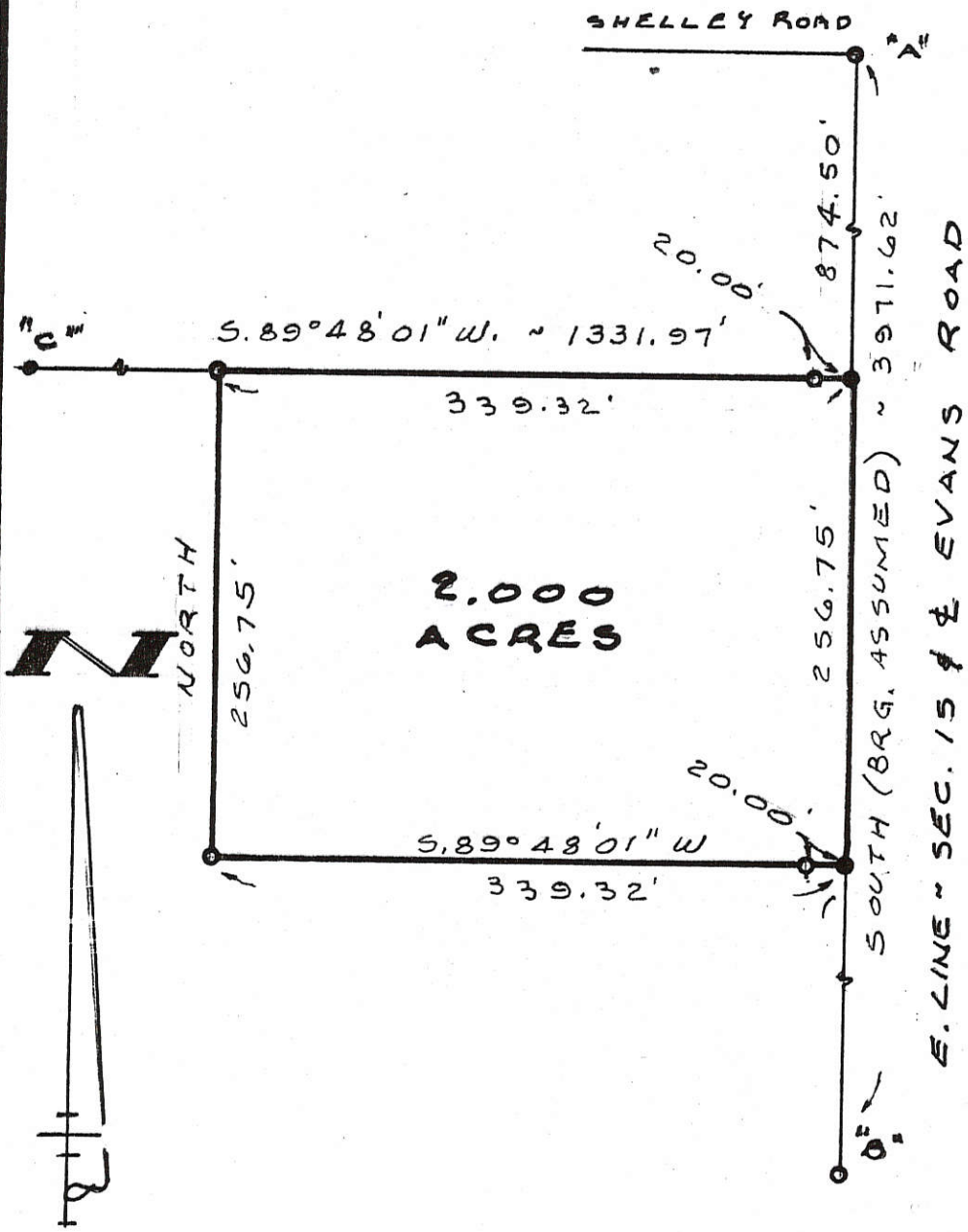

SURVEYED BY Gordon L. Geeslin
 GORDON L. GEESLIN
 REGISTERED SURVEYOR
 NO. 5372

ROLSTON SURVEY

PART OF THE N.E. 1/4 OF SECTION 15, TOWN 4 SOUTH,
 RANGE 3 EAST (UNION TWP.), MERCER COUNTY, OHIO.
 SEPT. 15, 1995 SCALE 1" = 100'

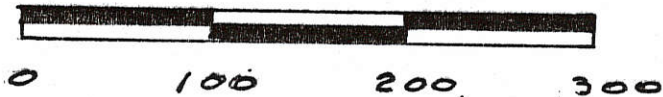

GEESLIN LAND SURVEYING

810 EAST MARKET STREET
 CELINA, OHIO
 PHONE (419) 586-6155



PERMANENT PARCEL No. _____

Part of: _____ Sec. _____ T _____ R _____ Township

Grantor: _____ Area Retained: _____ Acres

Grantee: _____ Area Transferred: _____ Acres

Deed References: _____

APPROVALS:
 AGENCY: _____ DATE: _____
 Board of Health County Sanitary Engineer County Engineer

03-15-200-003
-007
-008

03-E

CORE CONSULTING

1575 S. Defiance Trail
Spencerville, Ohio 45887
(419) 647-6163

CLIENT: James A. Pohlman
COUNTY: Mercer TWP/CITY: Union
TOWNSHIP: 4-SOUTH RANGE: 3-EAST
SECTION: Part of the NE 1/4, SEC 15
LOT #:
SUBDIVISION:

DATE: 10-09-00
SHEET 1 OF 3

SURVEYED BY: B.J.C.
SCALE: 1" = 200'

Survey of a parcel of land in the NE 1/4 of Section 15, T4S, R3E, Union Township, Mercer County, Ohio.

- A - PK nail set
- B - #5 Rebar set
- C - Existing #5 Rebar
- D - Existing Railroad Spike at the intersection of Shelley Rd (North Line of the NE 1/4 of Section 15) and Evans Road (East Line of the NE 1/4 of Section 15)
- E - Existing Iron Bar, NW corner of Section 15

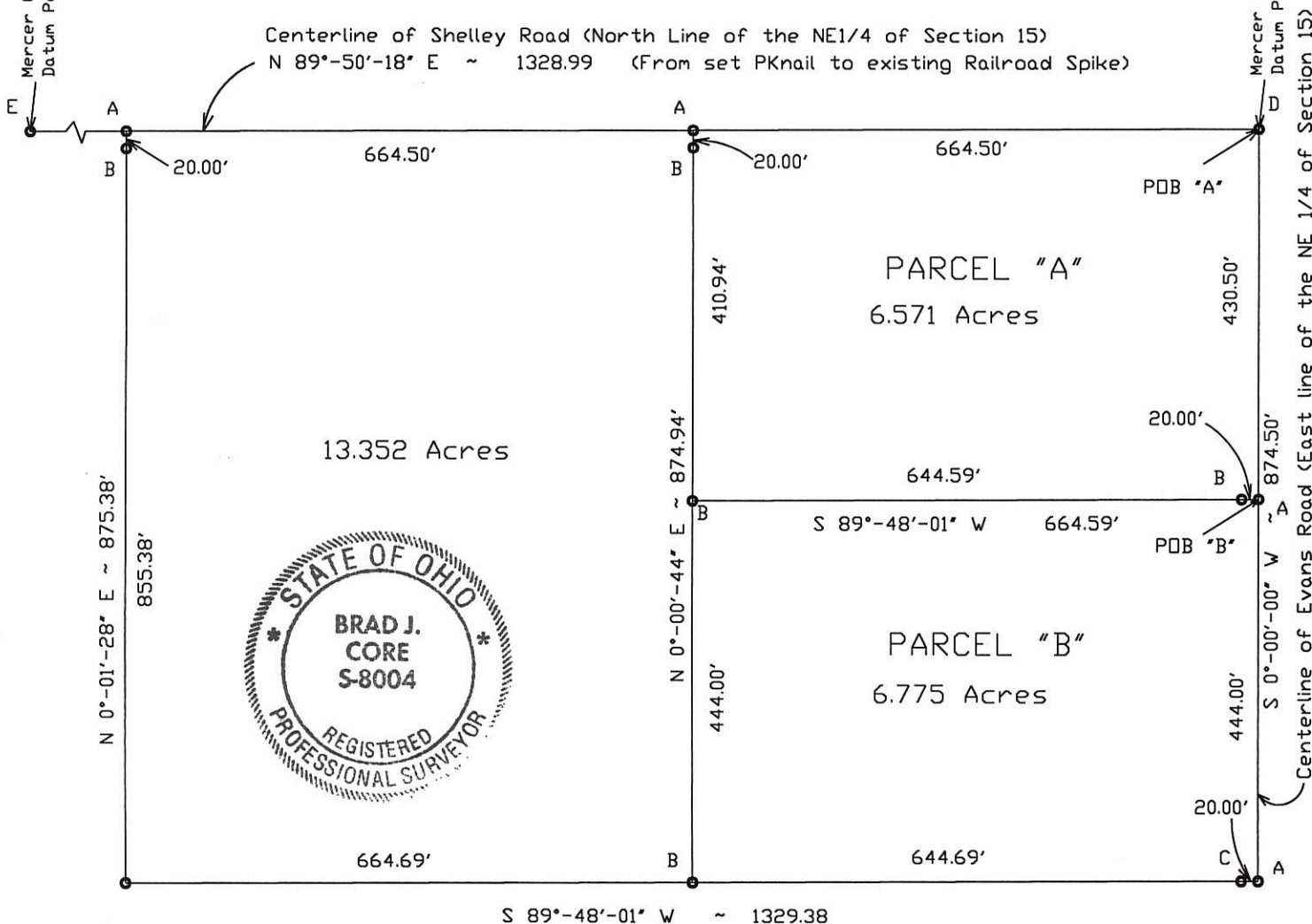

The basis of bearings for this survey is based on the assumption that the centerline of Evans Road (east line of the NE 1/4 of section 15) is N 00°-00'-00" E.

Brad J. Core, P.S. #8004

CORE CONSULTING

A Division of Materials Testing, Inc.

1660 S. Defiance Trail
Spencerville, Ohio 45887
(419) 647-6163

CLIENT: Patricia L. Eckart
COUNTY: Mercer TWP/CITY: Union
TOWNSHIP: 4-SOUTH RANGE: 3-EAST
SECTION: 15
LOT #:
SUBDIVISION:
DATE: 10-22-00 SURVEYED BY: B.J.C.
REVISED: 11-05-03
SHEET 1 OF 4 SCALE: 1" = 100'

Survey of a parcel of land in the NE 1/4 of Section 15, T4S, R3E,
Union Township, Mercer County, Ohio.

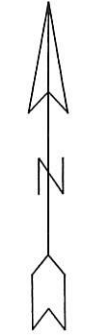
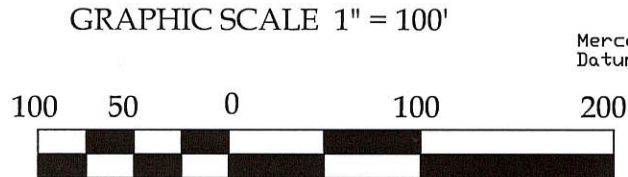

Michelle R. Shields
DR 141 Page 586
N 0°-00'-44" E ~ 440.00'

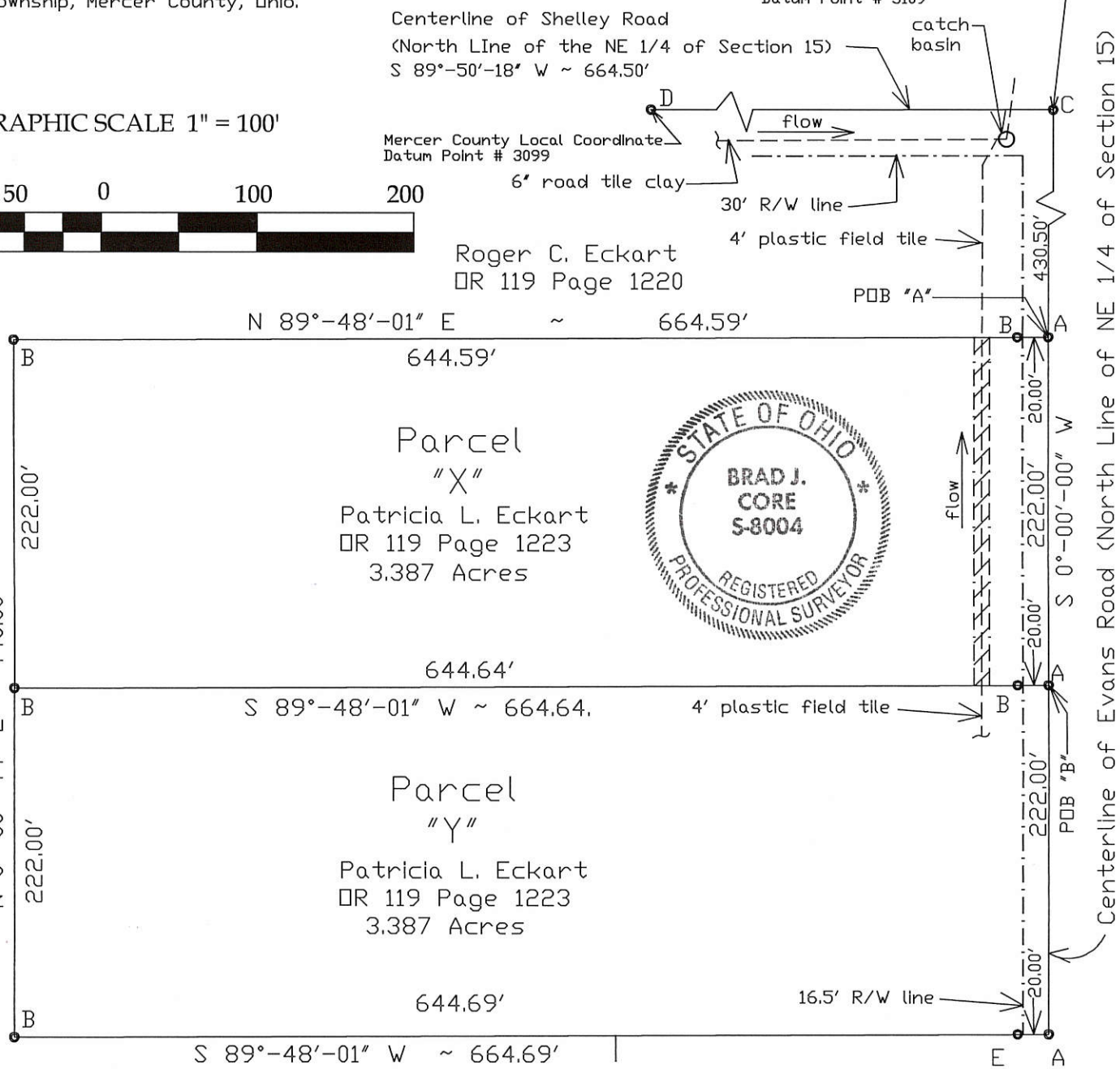

Stephen L. & Sandra L. Houser
Deed Vol. 93 Page 202

Ira Clem & Debra Ralston
Deed Vol. 334 Page 50

Approved by:

LEGEND

- A - PK nail set
- B - #5 Rebar set
- C - Existing Railroad Spike at the interesection of Shelley Rd (North Line of the NE 1/4 of Section 15) and Evans Road (East Line of the NE 1/4 of Section 15).
- D - Existing Iron Bar, NW corner of Section 15
- E - Existing # 5 Rebar
- Proposed drainage easement for stormwater & septic system outlet.

Mercer County RPC
Heron Eichler 11-14-03
Mercer County Engineer
Chris Muto 11-14-03
Mercer County Health Dept.
Stephen Eo Burgett
Union Township Zoning Official

The basis of bearings for this survey is based on the assumption that the centerline of Evans Road (east line of the NE 1/4 of section 15) is N 00°-00'-00" E.

Brad J. Core
Brad J. Core, P.S. #8004

CORE CONSULTING

1575 S. Defiance Trail
Spencerville, Ohio 45887
(419) 647-6163

CLIENT: Patricia L. Eckart
 COUNTY: Mercer TWP/CITY: Union
 TOWNSHIP: 4-SOUTH RANGE: 3-EAST
 SECTION: 15
 LOT #:
 SUBDIVISION:

DATE: 10-09-00
SHEET 1 OF 3

SURVEYED BY: B.J.C.
SCALE: 1" = 100'

Survey of a parcel of land in the NE 1/4 of Section 15, T4S, R3E,
Union Township, Mercer County, Ohio.

- A - PK nail set
- B - #5 Rebar set
- C - Existing Railroad Spike at the interesection of
Shelley Rd (North Line of the NE 1/4 of Section 15) and
Evans Road (East Line of the NE 1/4 of Section 15).
- D - Existing Iron Bar, NW corner of Section 15
- E - Existing # 5 Rebar



Centerline of Shelley Road
(North Line of the NE 1/4 of Section 15)
S 89°-50'-18" W ~ 664.50'

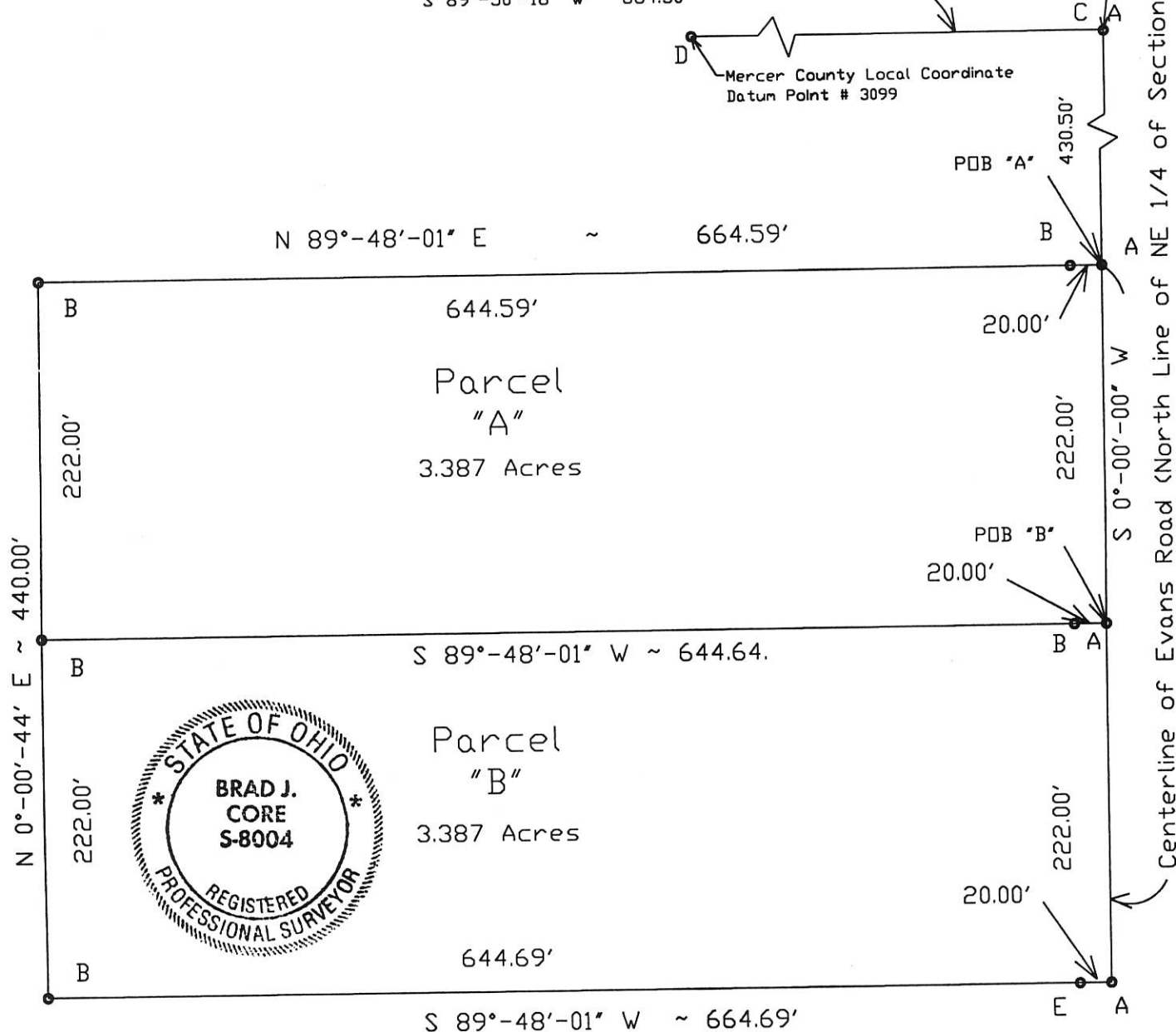

The basis of bearings for this survey is based on the assumption that the centerline of Evans Road (east line of the NE 1/4 of section 15) is N 00°-00'-00" E.

Brad J. Core
Brad J. Core, P.S. #8004

03-15-200-003
 - 0088
 - 007

CORE CONSULTING

1660 S. Defiance Trail
 Spencerville, Ohio 45887
 (419) 647-6163

CLIENT: James A. Pohlman
 COUNTY: Mercer TWP/CITY: Union
 TOWNSHIP: 4-SOUTH RANGE: 3-EAST
 SECTION: Part of the NE 1/4, SEC 15
 LOT #:
 SUBDIVISION:
 ADDRESS: 105 Broadway
 Spencerville, Ohio, 45887
 DATE: 10-09-00 SURVEYED BY: B.J.C.
 SHEET 1 OF 2 SCALE: 1" = 200'

Revised : 3/25/2002

Survey of a parcel of land in the NE 1/4 of Section 15, T4S, R3E,
 Union Township, Mercer County, Ohio.

- A - PK nail set
- B - #5 Rebar set
- C - Existing #5 Rebar
- D - Existing Railroad Spike at the intersection of
 Shelley Road (North line of the NE 1/4 of Section 15)
 and Evans Road (East line of the NE 1/4 of Section 15)
- E - Existing Iron Bar, NW corner of Section 15
- F - Existing Concrete Post

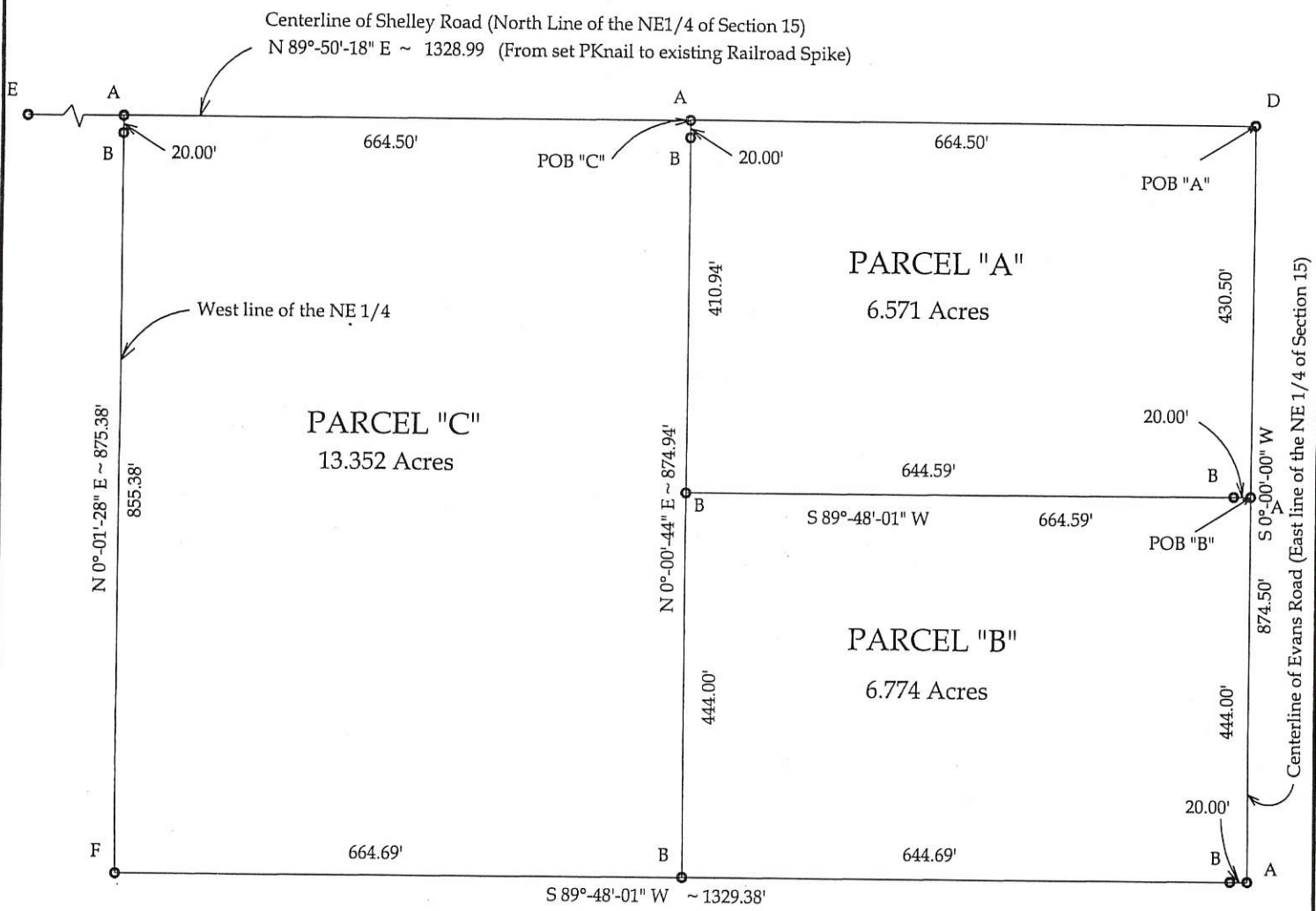

Brad J. Core
 Brad J. Core, P.S. #8004

"A" = 0315200008; "B" = 0315200010

D' = 0315200012
03-E

C' = 0315200011

CORE CONSULTING

A Division of Materials Testing, Inc.

1660 S. Defiance Trail
Spencerville, Ohio 45887
(419) 647-6163

CLIENT: Roger Eckart
COUNTY: Mercer TWP/CITY: Union
TOWNSHIP: 4-SOUTH RANGE: 3-EAST
SECTION: Part of the NE 1/4, SEC 15
LOT #:
SUBDIVISION:
ADDRESS:
DATE: 10-22-00 SURVEYED BY: B.J.C.
REVISED: 11-05-03
SHEET 1 OF 7 SCALE: 1" = 100'

Survey of a parcel of land in the NE 1/4 of Section 15, T4S, R3E,
Union Township, Mercer County, Ohio.

Mercer County Local Coordinate
Datum Point # 3109

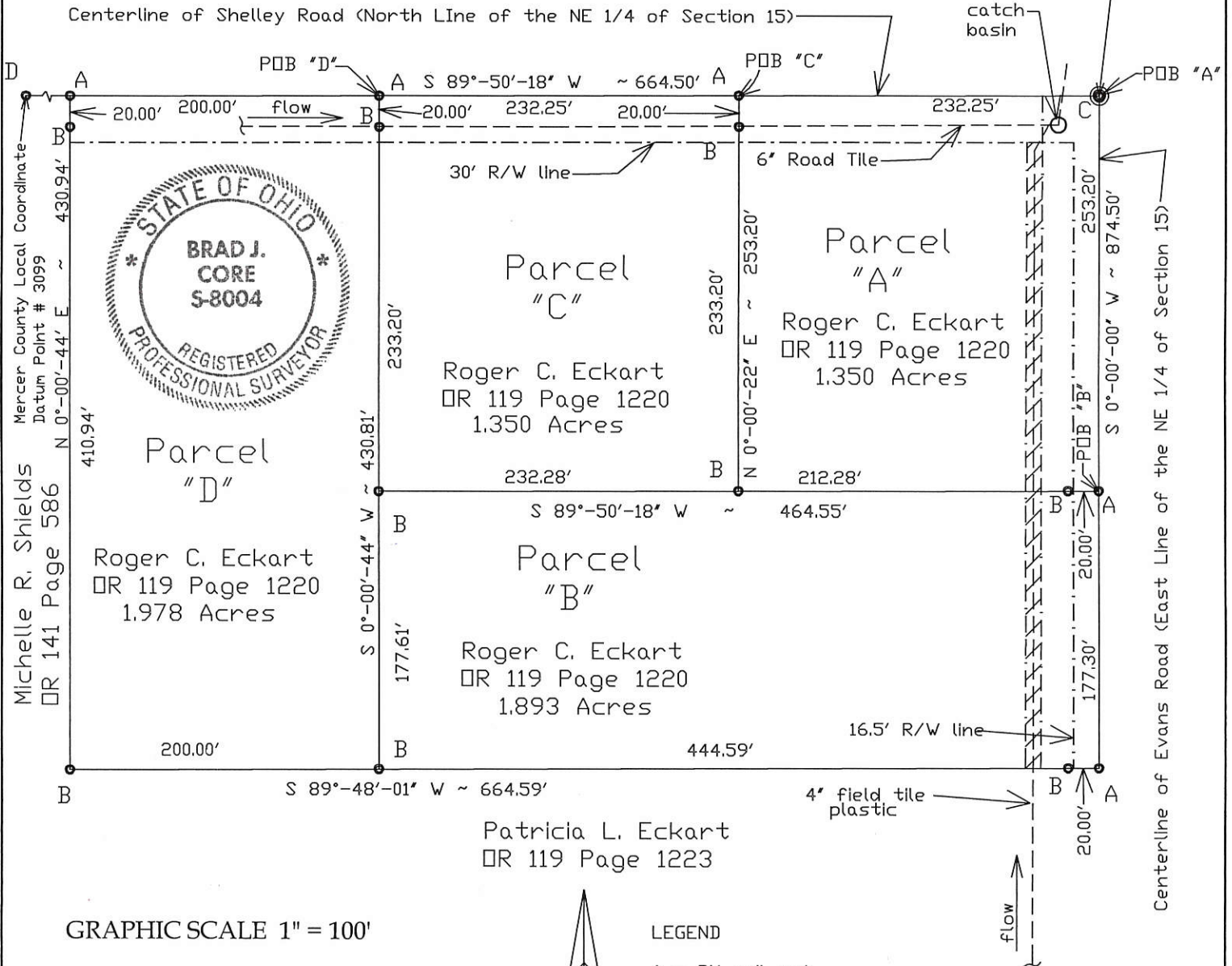

Michelle R. Shields
OR 141 Page 586

Centerline of Evans Road (East Line of the NE 1/4 of Section 15)

GRAPHIC SCALE 1" = 100'



Approved by:

Mercer County RPC
Vernon Eichler 11-14-03
Mercer County Engineer

Chris Muth 11-14-03
Mercer County Health Dept.

Marian Es Buvett
Union Township Zoning Official

LEGEND

- A - PK nail set
- B - #5 Rebar set
- C - Existing Railroad Spike at the Intersection of Shelley Rd (North Line of the NE 1/4 of Section 15) and Evans Road (East Line of the NE 1/4 of Section 15).
- D - Existing Iron Bar, NW corner of Section 15
- E - Existing # 5 Rebar
- Proposed drainage easement for stormwater & septic system outlet.

The basis of bearings for this survey is based on the assumption that the centerline of Evans Road (east line of the NE 1/4 of section 15) is N 00°-00'-00" E.

Brad J. Core
Brad J. Core, P.S. #8004

0315200011; 0315200010 'B'
 0315200012

03-15-200-008 'A' 03E

CORE CONSULTING

1575 S. Defiance Trail
 Spencerville, Ohio 45887
 (419) 647-6163

CLIENT: Roger Eckart
 COUNTY: Mercer TWP/CITY: Union
 TOWNSHIP: 4-SOUTH RANGE: 3-EAST
 SECTION: Part of the NE 1/4, SEC 15
 LOT #:
 SUBDIVISION:
 ADDRESS:

DATE: 10-09-00 SURVEYED BY: B.J.C.
 SHEET 1 OF 5 SCALE: 1" = 100'

Survey of a parcel of land in the NE 1/4 of Section 15, T4S, R3E,
 Union Township, Mercer County, Ohio.

- A - PK nail set
- B - #5 Rebar set
- C - Existing Railroad Spike at the interesection of
 Shelley Rd (North Line of the NE 1/4 of Section 15) and
 Evans Road (East Line of the NE 1/4 of Section 15).
- D - Existing Iron Bar, NW corner of Section 15

Centerline of Shelley Road (North Line of the NE 1/4 of Section 15)
 S 89°-50'-18" W ~ 664.50'

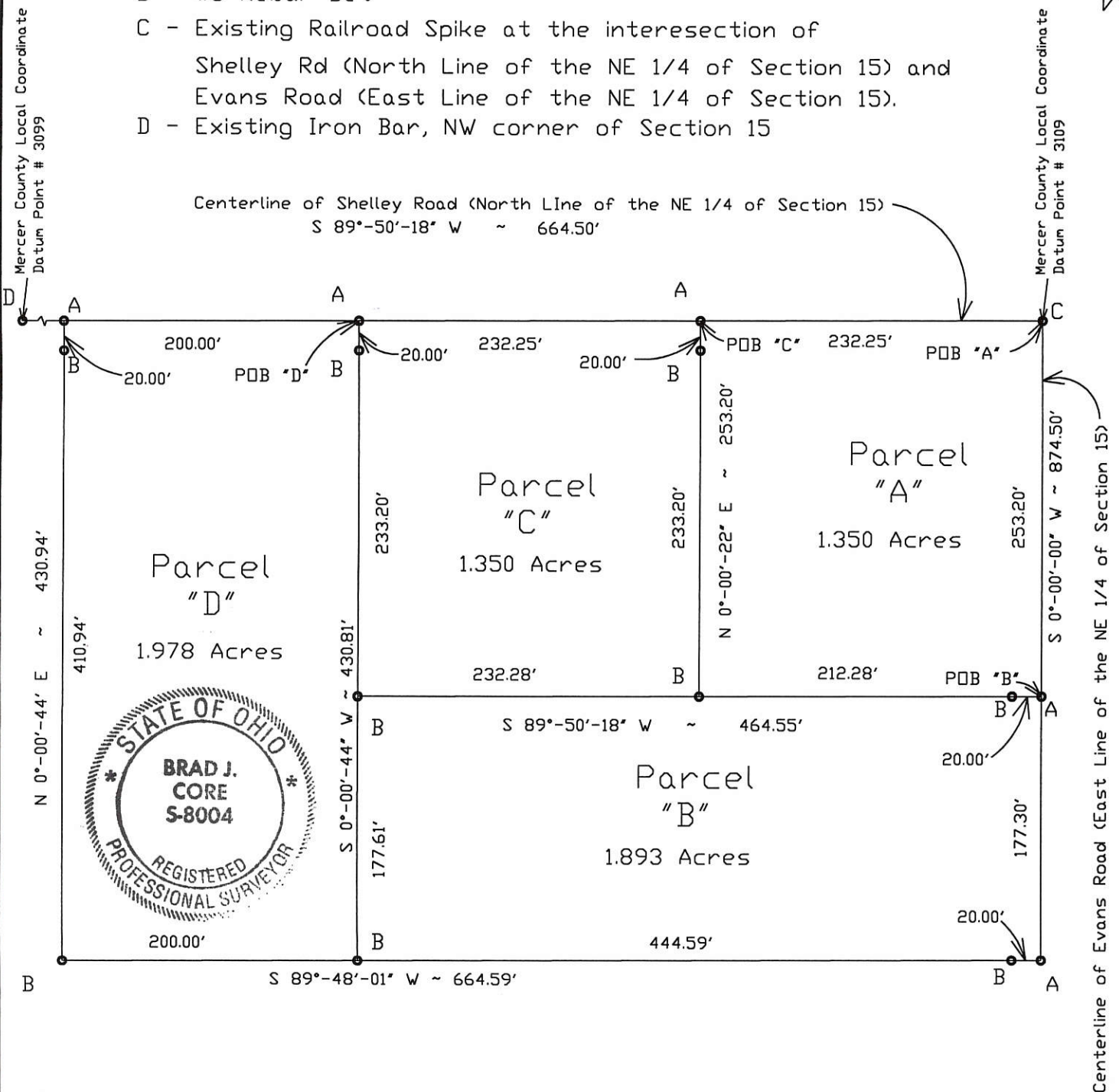

The basis of bearings for this survey is based on the assumption that the centerline of Evans Road (east line of the NE 1/4 of section 15) is N 00°-00'-00" E.

Brad J. Core
 Brad J. Core, P.S. #8004

03-E
03-15-200-006
-005

LEGEND

- = P.K. NAIL FD.
- "A" = CONC. POST FD. ~ S. 89° 48' 01" W. ~ 2.60 FROM COR. (DISTANCES ARE TO COR.).
- "B" = 5/8" BAR FD.
- ∅ = P.K. NAIL SET.
- = 5/8" IRON BAR SET.

SURVEYED BY James W. Geeslin
JAMES W. GEESLIN
P.S. 7764

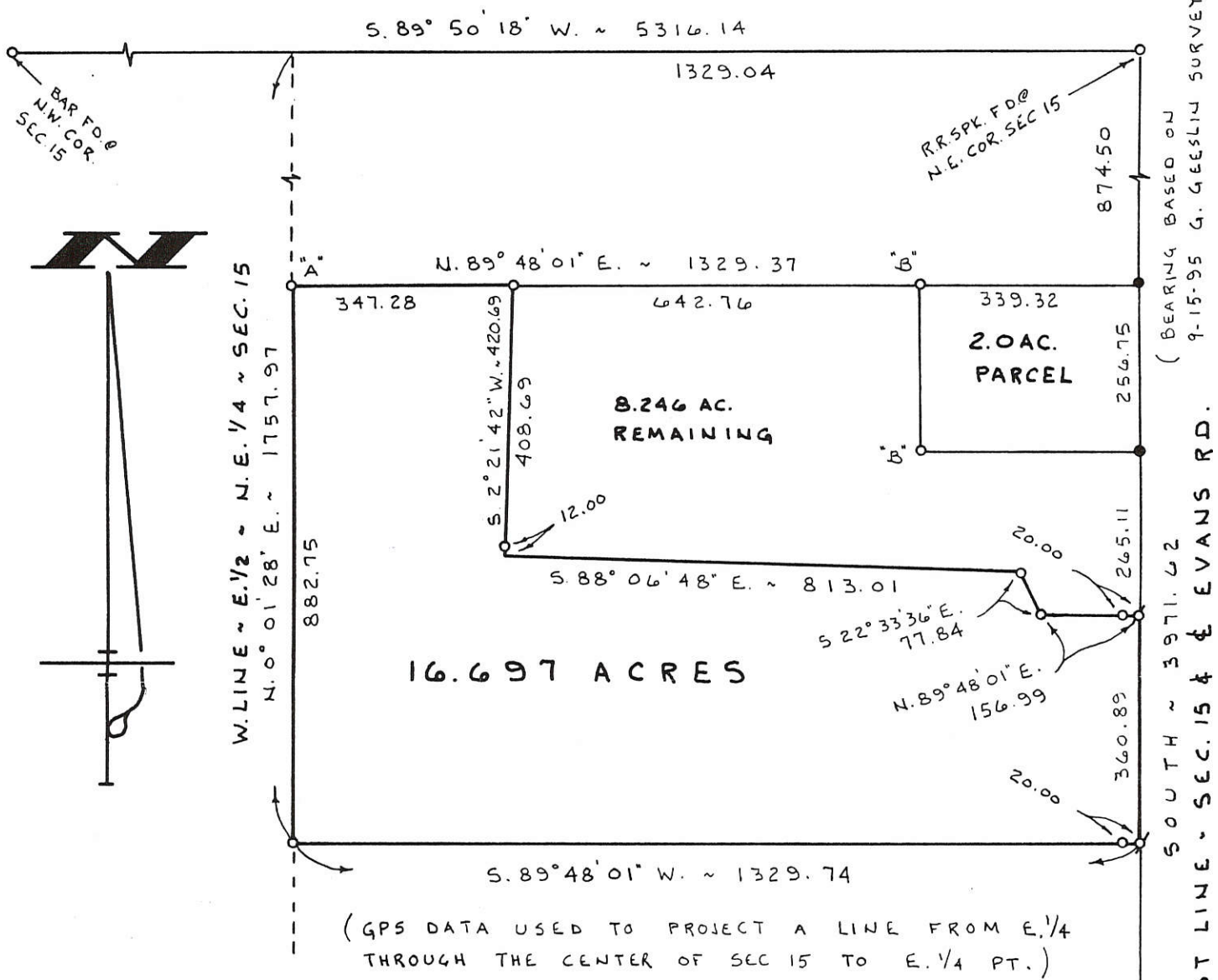

NEVERGALL SURVEY

PART ~ N.E. 1/4 ~ SECTION 15, T. 4 S.,
R. 3 E., (UNION TOWNSHIP), MERCER
COUNTY, OHIO.

AUGUST 31, 1998

SCALE 1" = 200'

**GEESLIN
LAND SURVEYING**
P. O. BOX 422
804 EAST MARKET STREET
CELINA, OHIO
PHONE (419) 586-6155



PERMANENT PARCEL No. _____

Part of: _____ Sec. _____ T _____ R _____ Township _____

Grantor: _____ Area Retained: _____ Acres

Grantee: _____ Area Transferred: _____ Acres

Deed References: _____

APPROVALS:

AGENCY: Board of Health	County Sanitary Engineer	County Engineer
DATE: _____		

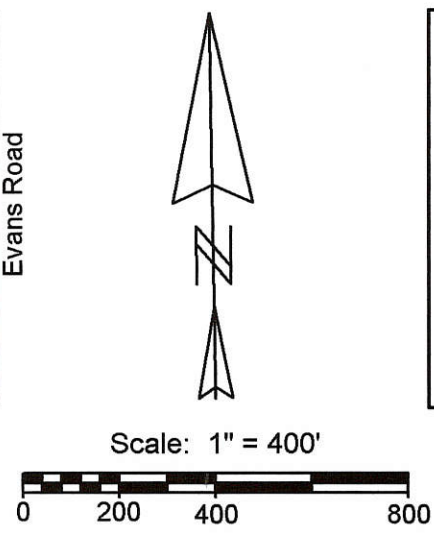

Legend:

- ▲ Cornerstone found @ the E1/4 post of Section 15
- ▲ Iron pipe @ the center of Section 15
- △ S1/4 post Section 15, Cornerstone gone set 5/8" X 30" iron pin w/cap from remaining references
- ⊗ Cornerstone found @ the SE corner of Section 15
- 5/8" X 30" Iron pin w/cap set on line and 20.0' from corner
- Mag nail set

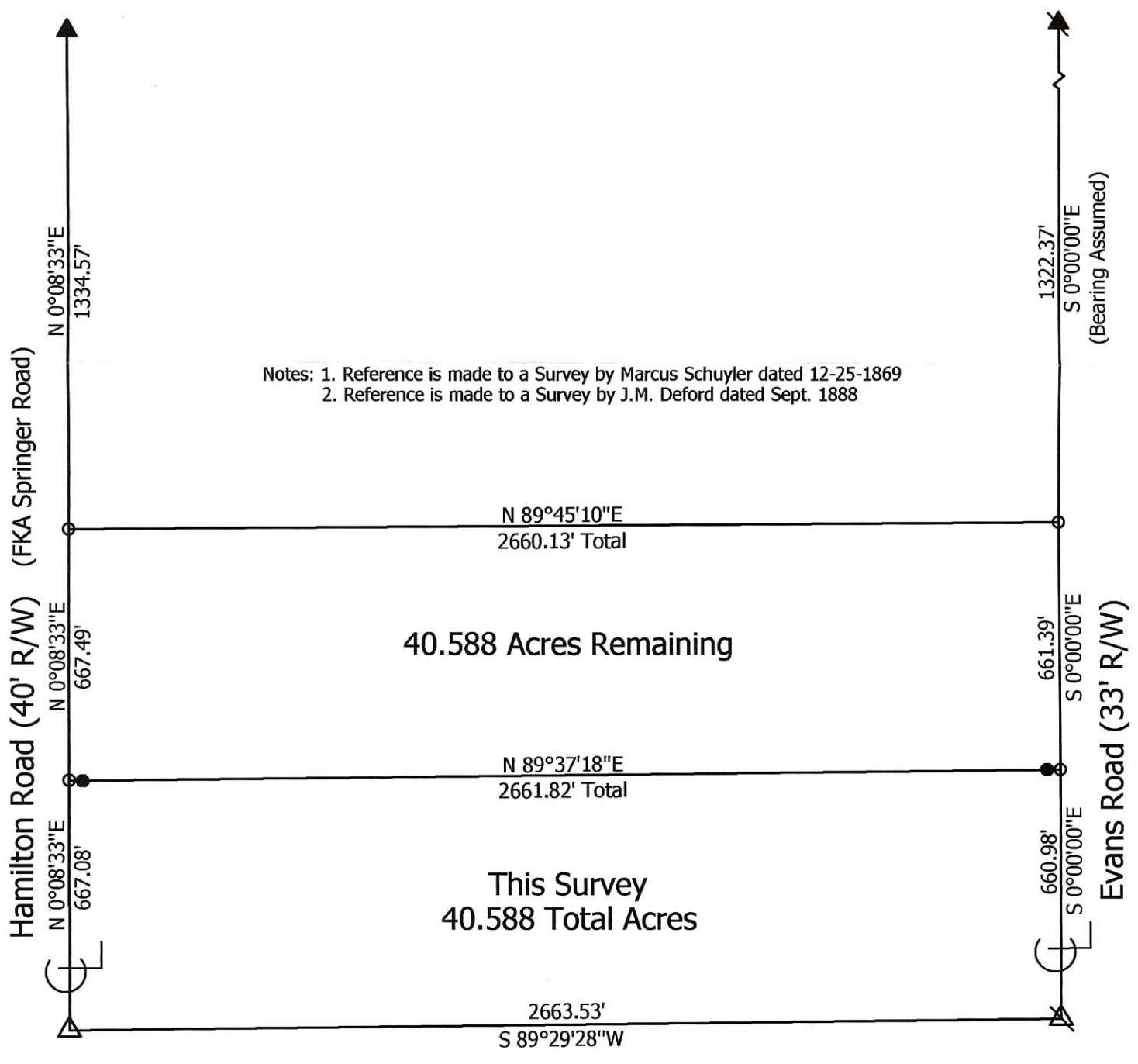

**Marbaugh
Land Surveying**

1901 Carolina Court
Celina, Ohio 45822
(419) 586-4293

Kent Marbaugh
Kent B. Marbaugh P.S.7421



Davis Survey

State of: Ohio County: Mercer

Township: Union Sec: 15 Town: 4S Range: 3E

City/Village: _____ Subdivision: _____ Lot: _____

Deed References: Inst.# 200800002258 & O.R. 81, Pg.965 Date Surveyed: 1-4-10

Approvals: _____	Township Zoning Inspector	County Engineer
Agency: <u>Board of Health</u>		
Date: _____		

YOCUM SURVEY

NW 1/4 SE 1/4, NE 1/4 SW 1/4 & N. PART SE 1/4 SW 1/4, SEC. 15, T4S, R3E, UNION TWP.
MERCER CO., OHIO

DEED REF. VOL 178 Pg 250

LOCATION PLAT

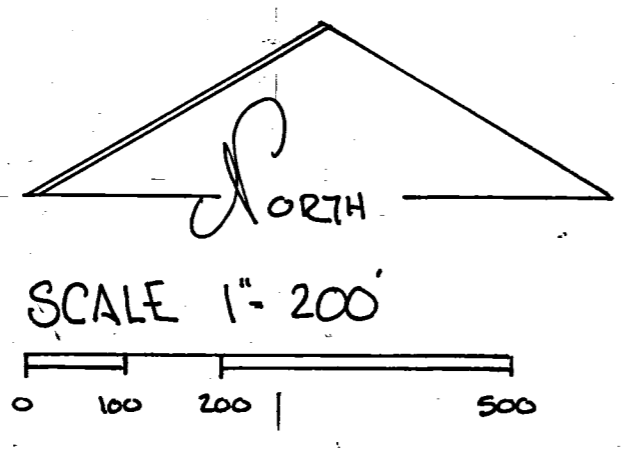
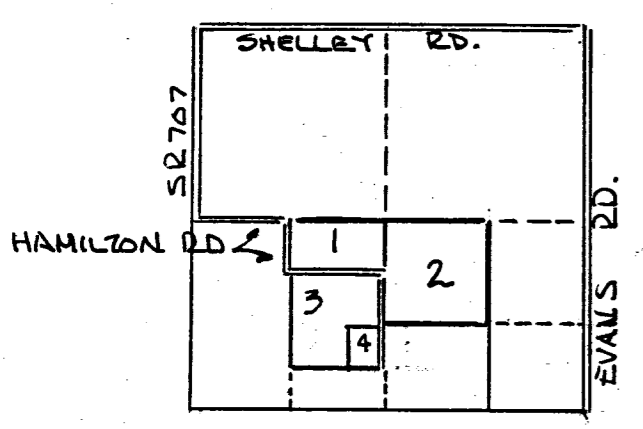

LEGEND

- △ STONE REF.
- IRON PIN FOUND
- IRON PIN SET
- EXISTING COR-POST

SEC. 15-UNION TWP.

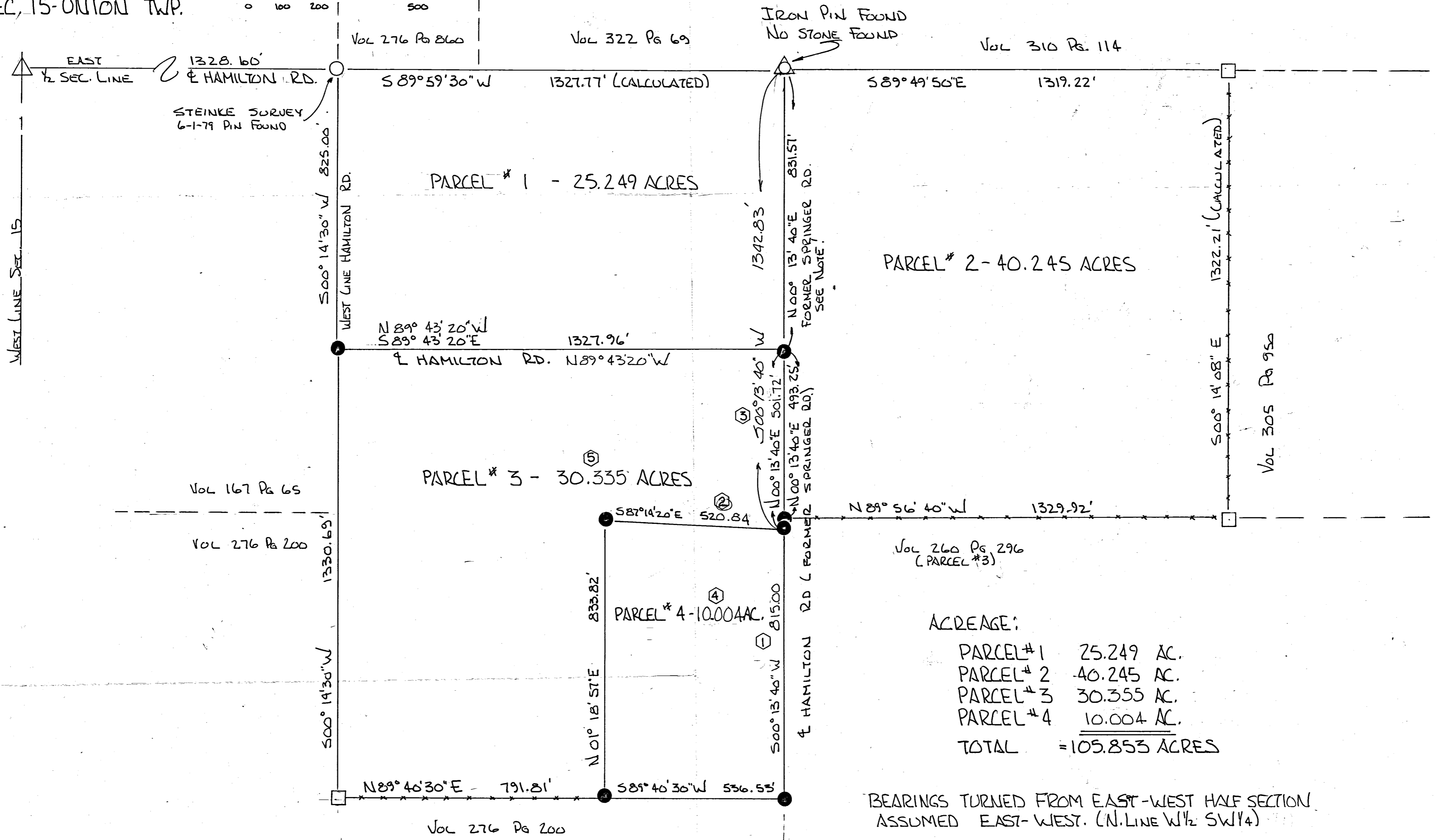

ACREAGE:

PARCEL #1	25.249 AC.
PARCEL #2	40.245 AC.
PARCEL #3	30.355 AC.
PARCEL #4	10.004 AC.
TOTAL	= 105.853 ACRES

BEARINGS TURNED FROM EAST-WEST HALF SECTION.
ASSUMED EAST-WEST. (N. LINE W 1/2 SW 1/4)

PLAT BY SURVEY DEC 1994 -
Roy F. Thompson, Jr. 1/10/94
ROY F. THOMPSON, JR. REG. SUR. # 5379

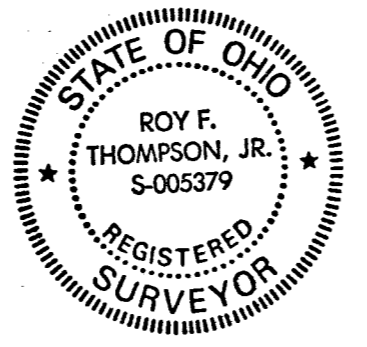

- REVISED MAY 19, 1994
- ① NEW DIMENSION 815.00'
 - ② NEW DIMENSION 520.84'
 - ③ NEW DIMENSION 501.72'
 - ④ RE-ESTABLISHED NORTH LINE PARCEL NO. 4 - INCREASING AREA TO 10.004 ACRES -
 - ⑤ REDUCED AREA PARCEL # 3 TO 30.355 ACRES -

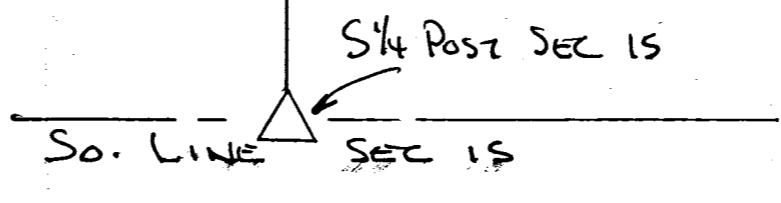

UNION

BK #2

SURVEY No. In Town *Trion* of Range *3* East. Plat and Notes of Survey made by me on the 17 day of *March*, A. D. 1920, in Sec. 15, Town 45, of Range 3 E, at the instance of *Clarence Rhodes and Perry Bogart*

UNION TWP.

CONDITION OF ORIGINAL CORNERS.

C. center of sec. stone post measured from witness tree W. Oak 58 1/2° E 55' found old stake, drove stake, and planted stone 10-12-3

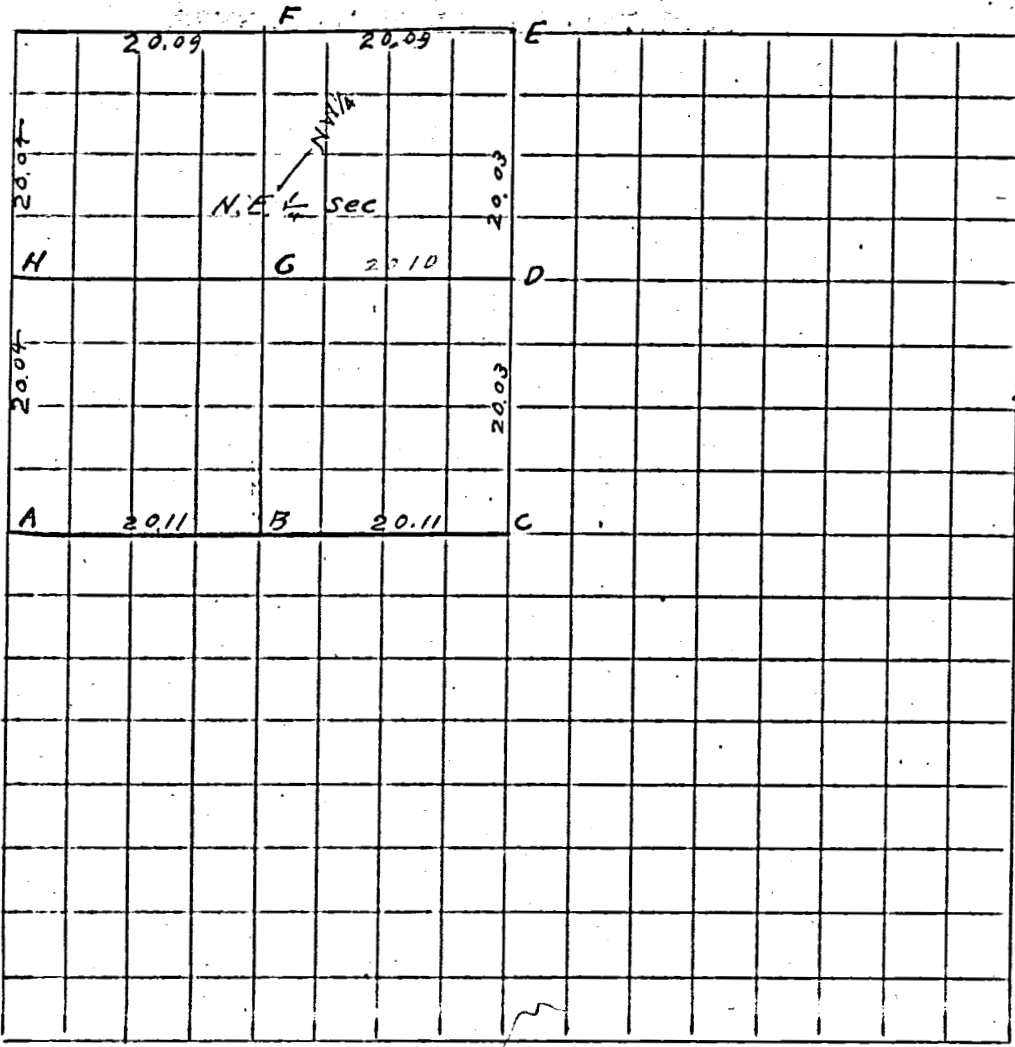

CORNERS DESCRIBED.	BEARING TREES.	D.	Course.	Dist.	BEARING TREES	D.	Course.	Dist.
A	W 1/2 Post sec. found stone in former survey							
B	corner post, planted stone on equal division line between A+C				sweet oak	15'	N 80° E	33'
D	Stake and 4" tile on equal division line between C and E							
E	Large stone in former survey, placed on top Lime stone 7-5-4							
F	stone in former survey							
H	" " " "							
G	Large concrete anchor post at intersection of lines B.F. & D.H							

I certify that the above recoded survey is correct

R.B. Harrison

R.B. Harrison Co. Supt

PAT O'NEILL SURVEY

03-E

03-15-100-003

UNION TWP. SECTION 15 T-4-S-R-3-E MERCER COUNTY OHIO

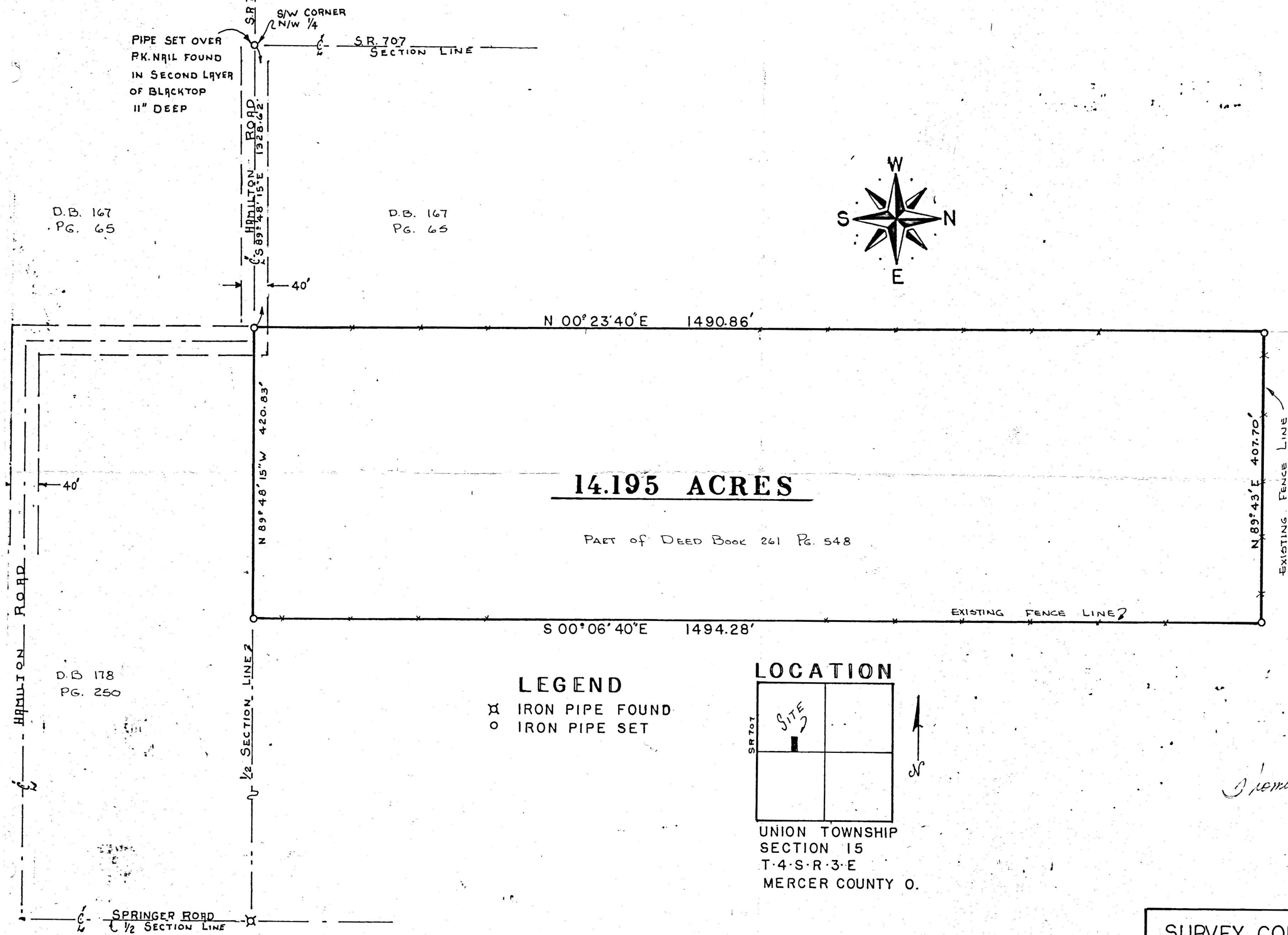

14.195 ACRES

PART OF DEED BOOK 261 PG. 548

LEGEND

- ⊗ IRON PIPE FOUND
- IRON PIPE SET

LOCATION

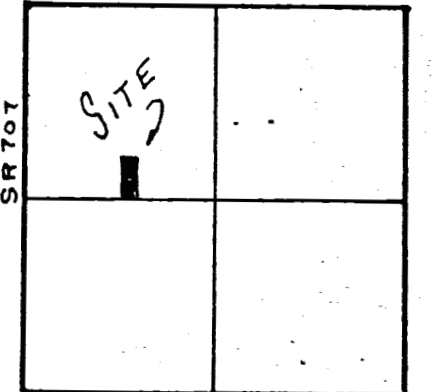

UNION TOWNSHIP
SECTION 15
T-4-S-R-3-E
MERCER COUNTY O.

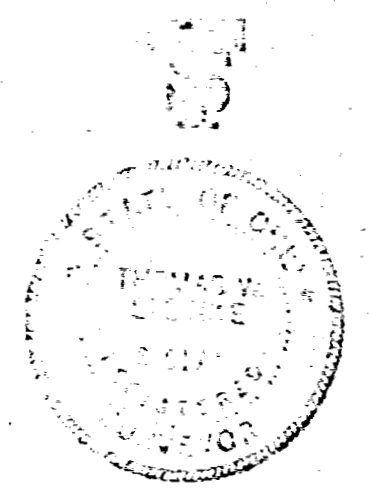

Thomas W. Steinke

SURVEY CONDUCTED BY:

THOMAS W. STEINKE & ASSOC. INC.
123 W. AUGLAIZE STREET
WAPAKONETA, OHIO 45895
PHONE 738-7421



DRWG. NO. 79-805

DATE: JUNE 1, 1979

SCALE: 1" = 100'

FILE NO. 79-805

SURVEY No. In Town 4 S of Range 3 East. Plat and Notes of Survey made by me on the
 14th 34/12th days of Sept. A. D. 1888, in Sec. 15, Town 4 S, of Range 3, at the instance of
 Wm Searns and David Furever

B.K 2 Union Tp

North

CONDITION OF ORIGINAL CORNERS.

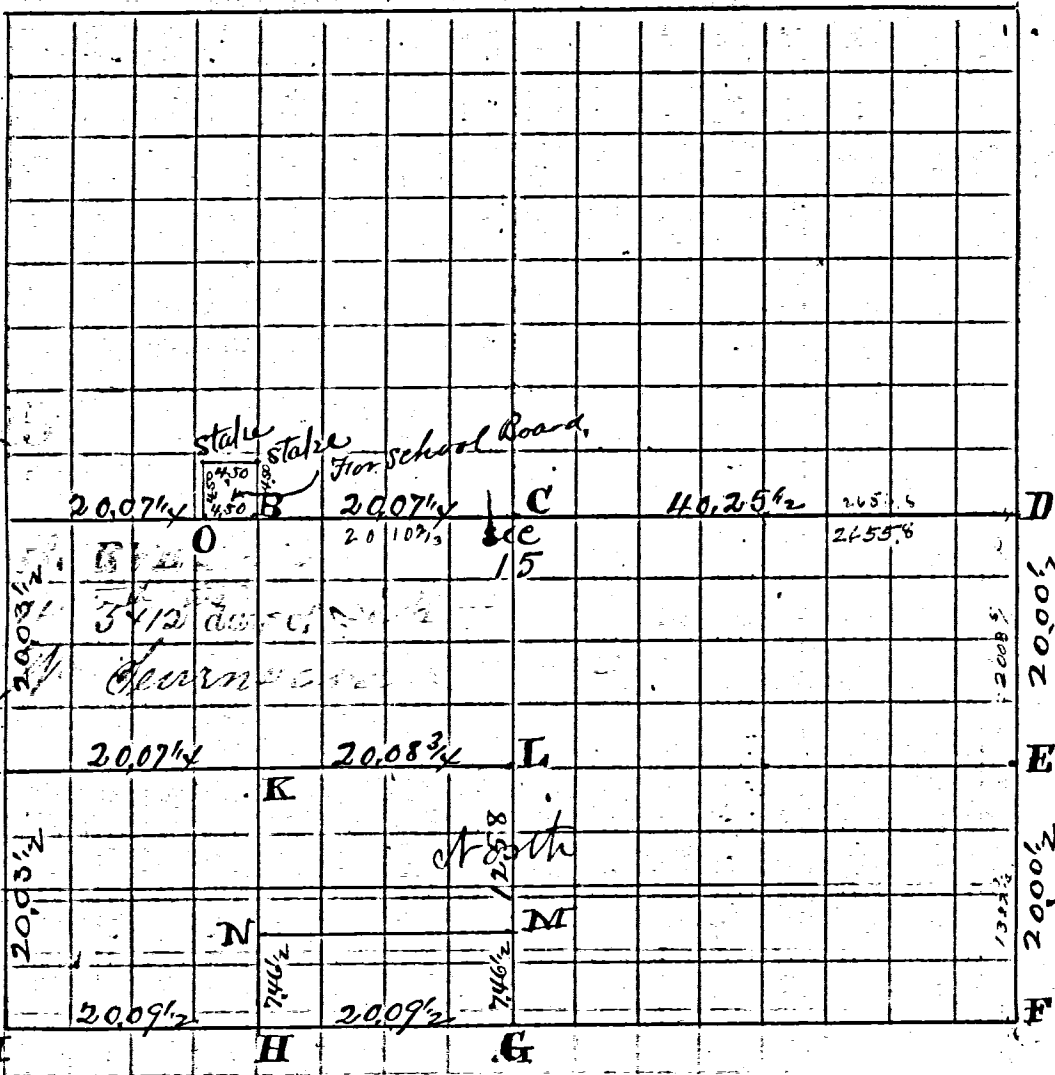

CONDITION OF ORIGINAL CORNERS.

CORNERS DESCRIBED.	BEARING TREES.	D.	Course.	Dist.	BEARING TREES	D.	Course.	Dist.
A N ¹ / ₄ Post Stone - no trees	This stone planted by a former Co Sur. & taken as correct.							
B Stake & bluish stone 13x11x4	1 mark Red Oak	16	S 79 ³ / ₄ E	70 ¹ / ₂ L.	W Oak	10	S 78 ³ / ₄ E	34 ¹ / ₂ L.
C Center of Sec at crossing of right line from Post	Put-down stake and flat boulder stone							
A 13x11x4 and mark	White Oak	27	S 59 ¹ / ₂ W	42 ¹ / ₂ L.	White Oak	6	S 88 ¹ / ₂ E	55 L.
D Stake and Stone at E ¹ / ₄ Post by former Sur. I mark	Elm	20	S 86 ¹ / ₂ W	84 L.	Elm	12	S 57 ¹ / ₂ W	82 ¹ / ₂ L.
E Stake and Stone.	1 mark Wild Cherry	12	S 71 E	75 L.				
F Stake and Stone by former Sur. I find	W. Oak	24	S 11 ¹ / ₂ W	58 instead of 57.	W. Oak	12	S 33 ¹ / ₂ W	89 L.
G Stone by former Sur. his wife	W. Oak	30	S 41 ¹ / ₂ W	62 L.	W. Oak	5	S 82 ¹ / ₂ W	57 L. standing green
H Stake & mark	W. Oak	25	S 16 ¹ / ₂ E	52 ¹ / ₂ L.	W. Oak	19	S 16 ¹ / ₂ W	43 ¹ / ₂ L.
I S ¹ / ₂ W. Cor. Sec. by former Sur. I mark	Blk Oak	14	S 38 ¹ / ₂ E	58 ¹ / ₂ L.	Blk Oak	17	S 75 ³ / ₄ E	71 ¹ / ₂ L.
J Stake & boulder stone 15, 10, 6	Small stone beneath Elm	36	S 20 ¹ / ₂ W	6 L.	Blk Oak	14	S 61 ¹ / ₂ E	121 ¹ / ₂ L.
K Stake & Stone 8x6x5	1 mark W. Oak	26	S 4 ¹ / ₂ W	28 L.				
L " " " 12x8x5	W. Oak	12	S 89 ¹ / ₂ E	103 L.	W. Oak	14	S 36 ¹ / ₂ W	80 ¹ / ₂ L.
M " " "	Hickory	8	S 64 ¹ / ₂ W	45 ³ / ₄ L.	Hickory	10	S 67 ¹ / ₂ W	32 L.
N " " Lime Stone	Burr Oak	12	S 55 E	43 "	White Hickory	17	S 64 ¹ / ₂ E	65 ¹ / ₂ L.
O " " blue Stone 11x7x7	Wild cherry	14	S 88 W	24 ¹ / ₂ L.				

I certify the above to be correct to the best of my knowledge & belief
 J. M. D. Ford Esq. Sur.
 Mercer Co. Ohio.

br-bug from Sec 15
 H Stake & mark W. Oak 25 S 16 1/2 E 52 1/2 L.
 I S 1/2 W. Cor. Sec. by former Sur. I mark Blk Oak 14 S 38 1/2 E 58 1/2 L.
 J Stake & boulder stone 15, 10, 6 Small stone beneath Elm 36 S 20 1/2 W 6 L. and Blk Oak 14 S 61 1/2 E 121 1/2 L.
 K Stake & Stone 8x6x5 1 mark W. Oak 26 S 4 1/2 W 28 L.
 L " " " 12x8x5 W. Oak 12 S 89 1/2 E 103 L. W. Oak 14 S 36 1/2 W 80 1/2 L.
 M " " " Hickory 8 S 64 1/2 W 45 3/4 L. Hickory 10 S 67 1/2 W 32 L.
 N " " Lime Stone Burr Oak 12 S 55 E 43 " White Hickory 17 S 64 1/2 E 65 1/2 L.
 O " " blue Stone 11x7x7 Wild cherry 14 S 88 W 24 1/2 L.

0322200001, 0322200003

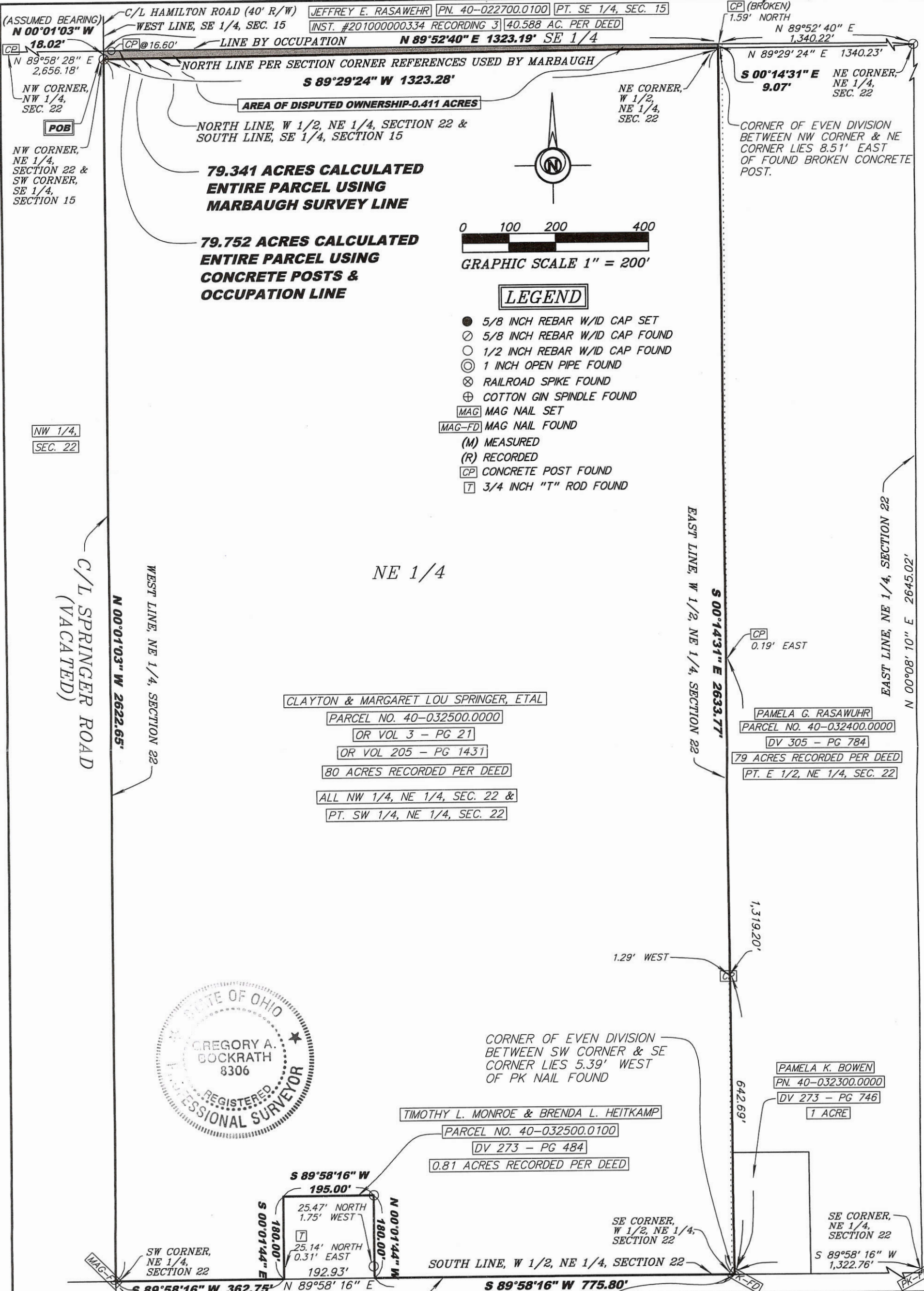

79.341 ACRES CALCULATED
ENTIRE PARCEL USING
MARBAUGH SURVEY LINE

79.752 ACRES CALCULATED
ENTIRE PARCEL USING
CONCRETE POSTS &
OCCUPATION LINE

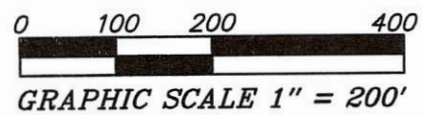

LEGEND

- 5/8 INCH REBAR W/ID CAP SET
- 5/8 INCH REBAR W/ID CAP FOUND
- 1/2 INCH REBAR W/ID CAP FOUND
- 1 INCH OPEN PIPE FOUND
- ⊗ RAILROAD SPIKE FOUND
- ⊕ COTTON GIN SPINDLE FOUND
- MAG MAG NAIL SET
- MAG-FD MAG NAIL FOUND
- (M) MEASURED
- (R) RECORDED
- CP CONCRETE POST FOUND
- T 3/4 INCH "T" ROD FOUND

CLAYTON & MARGARET LOU SPRINGER, ETAL
 PARCEL NO. 40-032500.0000
 OR VOL 3 - PG 21
 OR VOL 205 - PG 1431
 80 ACRES RECORDED PER DEED
 ALL NW 1/4, NE 1/4, SEC. 22 &
 PT. SW 1/4, NE 1/4, SEC. 22

PAMELA G. RASAWUHR
 PARCEL NO. 40-032400.0000
 DV 305 - PG 784
 79 ACRES RECORDED PER DEED
 PT. E 1/2, NE 1/4, SEC. 22

PAMELA K. BOWEN
 PN. 40-032300.0000
 DV 273 - PG 746
 1 ACRE

TIMOTHY L. MONROE & BRENDA L. HEITKAMP
 PARCEL NO. 40-032500.0100
 DV 273 - PG 484
 0.81 ACRES RECORDED PER DEED



CORNER OF EVEN DIVISION
 BETWEEN SW CORNER & SE
 CORNER LIES 5.39' WEST
 OF PK NAIL FOUND

THIS SURVEY WAS PERFORMED WITHOUT THE
 BENEFIT OF A TITLE EXAMINATION. BEYOND
 THE DEED DOCUMENTS CITED ON THE SURVEY
 DRAWING THERE MAY BE RECORDED OR UN-
 RECORDED EASEMENTS AND/OR
 ENCUMBRANCES BENEFITING OR ENCUMBERING
 THE SURVEYED PROPERTY WHICH ARE NOT
 SHOWN ON THIS DRAWING.

I HEREBY CERTIFY THIS TO BE A SURVEY MADE
 UNDER MY SUPERVISION AND THAT THE MONUMENTS
 ARE FOUND AND/OR SET AS INDICATED.

12-1-11
 Date

Gregory A. Bockrath P.S.
 Registered Surveyor No. 8306.
 137 West Third Street
 Ottawa, Ohio 45875
 419-523-5789

SURVEY FOR:
 CLAYTON & MARGARET SPRINGER
 ALL OF THE NW 1/4 OF THE NE 1/4 &
 PT. OF THE SW 1/4 OF THE NE 1/4 OF
 SECTION 22 & PT. OF THE SE 1/4 OF
 SECTION 15, T4S - R3E,
 UNION TOWNSHIP,
 MERCER COUNTY, OHIO

**Bockrath &
 Associates**
 Engineering and Surveying, LLC
 137 W. Third Street - Ottawa - Ohio
 Phone: 419.523.5789